

RADIO & TELEVISION NEWS

JULY
1949

RADIO-ELECTRONIC
ENGINEERING
EDITION

EVOLUTION OF A TELEVISION ANTENNA

page 56

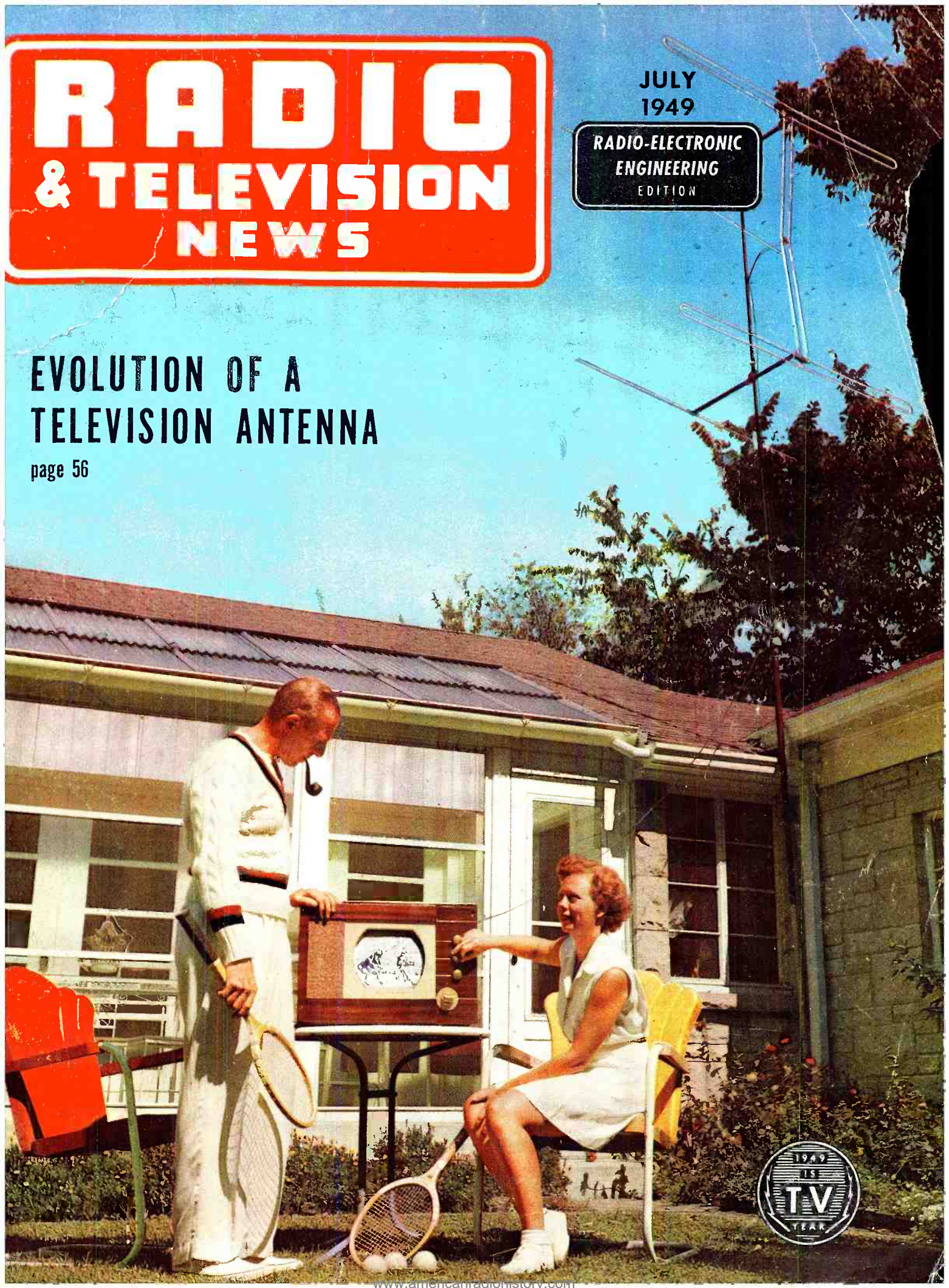

In Radio and Television Tube Sales

1949 IS A G-E YEAR

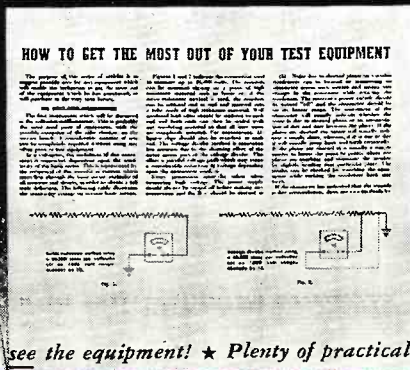

Clearly illustrated. You see the equipment! ★ Plenty of practical aid with your problems!

**Make 1949 your year for profits!
Read TECHNI-TALK! General Electric publishes
this new, useful service magazine to help you
get more tube, parts, and repair business.**



YOU'RE in a fast-moving profession, as radio-TV serviceman. Every day, new situations arise where you must know *what to do* to bring console-model radio, television receiver, or other sets up to par. Only by greater knowledge of methods, can you increase your repair volume . . . make your phone number the one owners dial when trouble occurs.

TECHNI-TALK is G.E.'s helpful answer to your need. Here's a bi-monthly service magazine edited by practical men for practical men—concise, down-to-earth, with just enough theory to give you the “why” of proved methods and time-saving short cuts. Read

every issue! Chances are, some problem awaiting you on your next round of service calls has been discussed, and solved for you, recently in TECHNI-TALK.

Your General Electric tube distributor will be glad to send you the latest TECHNI-TALK, and put you on his list for future issues. Phone or write him for your registration card! And don't forget: this expertly prepared magazine comes from a leading manufacturer of radio-TV equipment, in touch with service sources nationally. *You benefit from the sum total of G-E experience on any problem! Electronics Department, General Electric Company, Schenectady 5, New York.*

You can put your confidence in—

GENERAL  ELECTRIC

161-HAS

I WILL SEND YOU BOTH FREE

64 PAGE BOOK

Illustrated book tells how I give you practical experience with MANY KITS of Parts I send. Read how you make EXTRA MONEY fixing Radios in spare time while learning.

Read letters from men I trained, telling what they are doing and earning. See the fascinating jobs RADIO-TELEVISION offers. Book FREE with coupon below.

ACTUAL RADIO LESSON

Same coupon entitles you to actual lesson, "Getting Acquainted With Receiver Servicing" also FREE. Shows you that learning Radio-Television at home is easy, practical. Lesson tells how "superhet"

circuits work, three reasons why tubes fail, how to locate defects, repair loudspeaker, etc. Many pictures, diagrams. Get lesson FREE with coupon below.



See for yourself how I train you at home to BE A RADIO-TELEVISION TECHNICIAN

Want a good-pay job in the fast growing RADIO-TELEVISION industry? Want a money-making Radio-Television shop of your own? Here's your opportunity. I've trained hundreds of men to be successful Technicians. MEN WITH NO PREVIOUS EXPERIENCE. My tested and proved train-at-home method makes learning easy. You learn Radio-Television principles from illustrated lessons. You get practical experience building, testing, experimenting with MANY KITS OF PARTS I send. All equipment yours to keep.

MAKE EXTRA MONEY IN SPARE TIME

The day you enroll, I start sending SPECIAL BOOKLETS that show you how to make \$5, \$10 a week or more EXTRA MONEY fixing neighbors' Radios in spare time while learning. From here, it's a short step to your own shop or a good-pay Radio-Television servicing job. Or be a licensed Radio-Television Operator or Technician.

TELEVISION OFFERS BRIGHT FUTURE

Today there are nearly 2700 Radio stations on the air—and within three years experts predict there will be over 1000 Television Stations. Then add developments in FM, Two-Way Radio, Police, Marine, Aviation and Microwave Relay Radio! Think what this means. New jobs, more jobs, good pay for qualified men.

MAIL COUPON FOR BOOKS FREE

Act now! Coupon entitles you to actual lesson, "GETTING ACQUAINTED WITH RECEIVER SERVICING," and my 64-page book, "HOW TO BE A SUCCESS IN RADIO-TELEVISION." Send coupon in envelope or paste on penny postal. J. E. SMITH, President, Department 9GR, National Radio Institute, Pioneer Home Study Radio School, Washington 9, D. C.

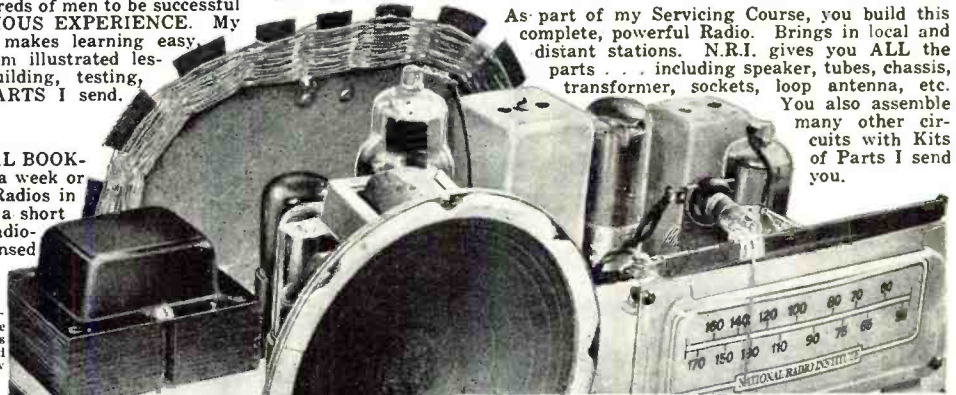

You Build This MODERN RADIO with Parts I Send

As part of my Servicing Course, you build this complete, powerful Radio. Brings in local and distant stations. N.R.I. gives you ALL the parts . . . including speaker, tubes, chassis, transformer, sockets, loop antenna, etc. You also assemble many other circuits with Kits of Parts I send you.

You Build This TRANSMITTER with Parts I Send

As part of my new Communications Course, you build this low-power Broadcasting Transmitter. You also build many other circuits with Kits of Parts I send you, that bring to life Radio-Television theory you learn.

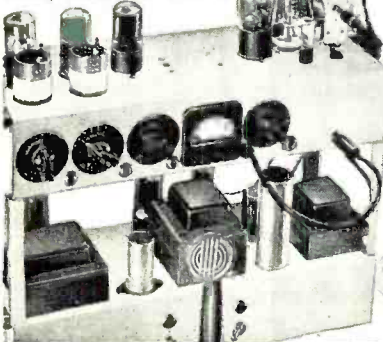

I TRAINED THESE ME

"Today I am considered an expert Radio and Television Technician. Have 4 employees working for me." —Paul Miller, Toledo, O.

"Halfway thru N.R.I. course, I made about \$8 a week in spare time fixing Radios." —E. Streitenberger, New Boston, O.

"Was a bookkeeper with a hand-to-mouth salary. Now a Radio Engineer with ABC Network." —N. Ward, N. J.

"I have my own shop, am making more money now than ever before." —Curtis Staeth, Ft. Madison, Iowa.



Actual Lesson and 64 Page Book FREE

MR. J. E. SMITH, President, Dept. 9GR
National Radio Institute, Washington 9, D. C.

Mail me Sample Lesson and 64-page Book about How to Win Success in Radio-Television—both FREE. (No salesman will call. Please write plainly.)

Name.....Age.....
Address.....
City.....Zone.....State.....
 Check if Veteran Approved Under G. I. Bill

VETERANS

GET THIS TRAINING WITHOUT COST UNDER G. I. BILL

Editor
OLIVER READ, W9ETI

Managing Editor
WM. A. STOCKLIN

Technical Editor
H. S. RENNE, EX-W8PTS

Associate Editor
RAY FRANK, W9JU

Contributing Editor
ROBERT HERTZBERG, W2DJJ

Short-Wave Editor
KENNETH R. BOORD

Staff Artist
R. S. KUPJACK

Advertising Manager
L. L. OSTEN

Midwest Adv. Manager
JOHN A. RONAN, JR.

Art Director
HERMAN R. BOLLIN

RAD O & TELEVISION NEWS

First in
radio-television-electronics

Average Paid Circulation over 181,000

Radio News Trade Mark Reg. U.S. Pat. Office No. 378427

CONTENTS

JULY, 1949

The New Field of Microwave Spectroscopy.....	Samuel Freedman	27
Television's Impact.....	Herbert S. Laufman	30
A 10-Meter Mobile Transmitter.....	Rufus P. Turner, K6AI	32
Build Your Own Geiger Counter.....	Walter B. Ford, W6YT	34
New TV Screen Offers Greater Contrast.....	U. A. Sanabria	37
Modern Television Receivers (Part 16).....	Milton S. Kiver	38
Mac's Radio Service Shop.....	John T. Frye	40
A Modern Mobile Transceiver.....	Harry R. Hyder, W3NVL	41
Disturbance Tests—A Short-Cut in TV Servicing.....	Cyrus Glickstein	46
The Beginning Amateur (Part 6).....	Robert Hertzberg, W2DJJ	50
Apartment Size 400-Watt Transmitter.....	Buford Smith, W9ZMD	52
Build Your Own TV Tower.....	Lyman E. Greenlee	55
Evolution of a TV Antenna.....	L. H. Finneburgh	56
Summary Of The New Proposed Amateur Rules And Regulations Of The FCC.....		60
Do You Know?.....	David Scott	76
Dry-Disc Rectifiers As Control Circuit Components.....	Ronald L. Ives	82
Save Testing Time With an "Outlet Box" Unit.....	Harry Leeper	86

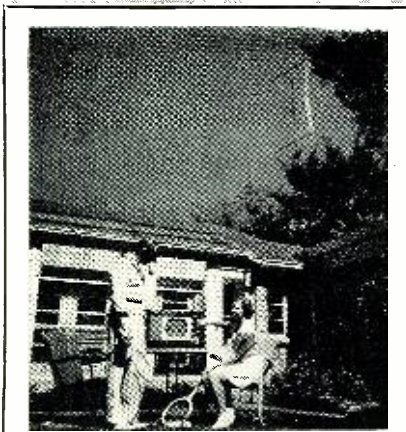

COVER PHOTO: Television is growing in popularity outdoors as well as in the home. R. H. G. Matthews and wife with their U.S.T. receiver and Ward antenna have picked up telecasts from 200 miles away. (Photo by W. Frank Jones)

Chairman of the Board and Publisher
WILLIAM B. ZIFF

President
B. G. DAVIS

Secretary-Treasurer
ARTHUR T. PULLEN

Vice-Presidents
MICHAEL H. FROELICH
Dir. Eastern Div.
H. J. MORGANROTH
Production Director
H. G. STRONG
Circulation Director

BRANCH OFFICES

NEW YORK (1)
Empire State Bldg., WI 7-0400

LOS ANGELES (14)
815 S. Hill St., TUcker 9213
Manager, **WILLIAM I. PINNEY**

TORONTO
21 King Street, East

ASSOCIATED WITH
Ziff-Davis, Ltd., Grumpium Bldg.
Western Gate, London, England

DEPARTMENTS

For the Record.....	The Editor	8	New TV Receivers.....	96
Spot Radio News.....		14	MARS.....	102
Within the Industry.....		20	AFCA News.....	108
Short-Wave.....	K. R. Boord	45	Technical Books.....	114
What's New in Radio.....		66	Manufacturers' Literature.....	122
Letters from Our Readers.....		128		



COPYRIGHT 1949
ZIFF-DAVIS PUBLISHING COMPANY
185 North Wabash Ave., Chicago 1, Ill.
VOLUME 42 • NUMBER 1



Member
Audit Bureau of
Circulations

RADIO & TELEVISION NEWS is published monthly by the Ziff-Davis Publishing Company, 185 N. Wabash Ave., Chicago 1, Ill. Subscription Rates: In U. S. and Canada \$4.00 (12 issues), single copies 35 cents; in Mexico, South and Central America, and U. S. Possessions, \$4.00 (12 issues); in British Empire, \$5.00 (12 issues)—all other foreign countries \$5.00 (12 issues). Subscribers should allow at least 2 weeks for change of address. All communications about subscriptions should be addressed to: Director of Circulation, 185 N. Wabash Ave., Chicago 1, Ill. Entered as second class matter July 21, 1948, at the Post Office, Chicago, Illinois, under the Act of March 3, 1879. Entered as second class matter at the Post Office Dept., Ottawa, Canada. Contributors should retain a copy of contributions and include return postage. Contributions will be handled with reasonable care but this magazine assumes no responsibility for their safety. Accepted material is subject to whatever revisions and by-line changes that are necessary. Payment made our current rates, covers all authors', contributors' or contestants' rights, title, and interest in and to accepted material, including photographs and drawings.

RADIO & TELEVISION NEWS

Six Months from Today Which will YOU hold?



WANT YOUR FCC COMMERCIAL LICENSE IN A HURRY?

Add Technical Training to Your Practical Experience and Get Your "Ticket" in a FEW SHORT WEEKS. It's EASY if You Use CIRE Simplified Training and Coaching AT HOME in SPARE TIME

Thousands of new jobs are opening up—FM, Television, Mobile Communication Systems. These are only a few of the radio fields which require licensed radio technicians and operators. Get your license without delay. Let Cleveland

Institute prepare you to pass FCC license examinations, and hold the jobs which a license entitles you to, with CIRE streamlined, post-war methods of coaching and training.

Your FCC Ticket Is Always Recognized in ALL Radio Fields As Proof of Your Technical Ability

More than ever before an FCC Commercial Operator License is a sure passport to many of the better paying jobs in this New World of Electronics. Employers always give prefer-

ence to the license holder, even though a license is not required for the job. Hold an FCC "ticket" and the job is yours!

Hundreds of Satisfied, Successful Students

"Transmitter engineering is great, especially on the job I am on. Thanks again for all you have done, and you can take the credit for the fact that my 'ticket' is now posted on the wall of a 1000 Watt broadcast station."
Student No. 3678N12

"I now hold ticket Number P-10-3787, and holding the license has helped me to obtain the type of job I've always dreamed of having. Yes, thanks to CIRE, I am now working for CAA as Radio Maintenance Technician, at a far better salary than I've ever had before. I am deeply grateful."
Student No. 3319N12

"I took the FCC examination on March 4th and received my second class radiotelephone license March 9th. I go to work for the Trans-Texas Airways in the maintenance department. Thanks for all the assistance."
Student No. 2394A1

"I take great pleasure in informing you that I have taken the examination for radio telephone first class license on June 29th, and passed and have received my license. I am now working at WCNH, a local 250 watt station."
Student No. 3171N12

OTHER Cleveland Institute Home Study Courses Offer Complete Technical Radio Training from Low-Level to College-Level, for the Radioman with Practical Experience!

- COURSE A** Master Course in Radio Communication—A complete course covering the technical fundamentals of radio-electronics, for the radioman who wants a general review. Includes preparation for Broadcast station employment.
- COURSE B** Advanced Course in Radio Communication Engineering—A genuine college-level radio engineering course, completely mathematical in treatment. For the advanced radioman with considerable practical experience and training.
- COURSE C** Special Television Engineering—An advanced college-level course for the radioman who has had formal training equivalent to A and B.
- COURSE D** Advanced Radio Telephony—An advanced, specialized course covering broadcast station engineering and operation. Covers the engineering knowledge and the technical duties required of the studio control operator, the master control operator, and the transmitter operator.

Get this AMAZING NEW BOOKLET

1. TELLS OF THOUSANDS OF BRAND-NEW, BETTER-PAYING RADIO JOBS NOW OPEN TO FCC LICENSE HOLDERS
2. TELLS HOW YOU WILL BENEFIT BY HOLDING AN FCC COMMERCIAL LICENSE.
3. TELLS HOW YOU CAN GET YOUR FCC COMMERCIAL RADIO OPERATOR LICENSE IN A FEW SHORT WEEKS—EASILY AND QUICKLY, BY USING CIRE SIMPLIFIED TRAINING AND COACHING AT HOME IN YOUR SPARE TIME.
4. TELLS OF HUNDREDS OF OUR SUCCESSFUL STUDENTS WHO NOW HAVE LICENSES AND NEW, BETTER-PAYING JOBS.
5. TELLS HOW WE PREPARE YOU TO PASS THE NEW FCC COMMERCIAL LICENSE EXAMINATIONS, WHICH NOW INCLUDE FM AND TELEVISION.



Mail Coupon At Once GET ALL 3 FREE

Approved for Veteran Training under "G. I. Bill of Rights"

CLEVELAND INSTITUTE OF RADIO ELECTRONICS
DESK RN-7, 4900 Euclid Building, Cleveland 3, Ohio (Address to Desk No. to avoid delay)

Please send me your Catalog C, "Money Making FCC License Information"; your Booklet B, "How to Pass FCC Commercial License Examinations" (does not cover Amateur License Examinations), and a sample FCC-type exam.
 Please send me your Catalog A, describing all of your home study radio-electronics courses. I desire training in course A B C D.

NAME
 ADDRESS
 CITY ZONE STATE

Veterans check for enrollment information under G. I. Bill. NO OBLIGATION—NO SALESMEN

6. TELLS HOW WE GUARANTEE TO TRAIN AND COACH YOU UNTIL YOU GET YOUR LICENSE
7. TELLS HOW WE HELP YOU TO GET A BETTER-PAYING, LICENSED JOB WITH OUR FREE AND EXCLUSIVE SERVICE, WHICH PREPARES YOUR EMPLOYMENT APPLICATION FOR MAILING TO HUNDREDS OF EMPLOYERS INCLUDING FM, AM AND TELEVISION BROADCAST STATIONS, RADIO MANUFACTURERS, POLICE RADIO STATIONS, AND RADIO-EQUIPPED TAXI, BUS AND PUBLIC UTILITY COMPANIES

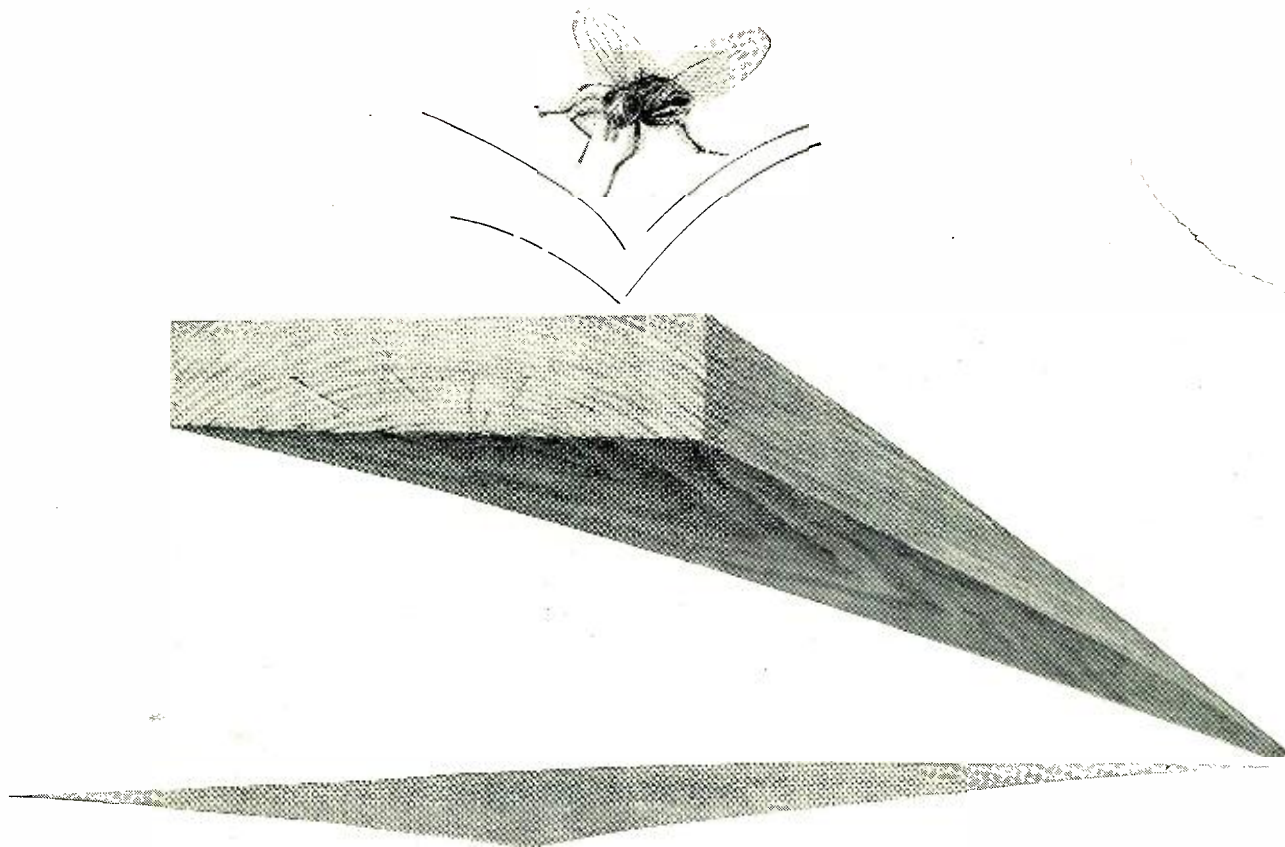

Supersensitive electron tube, developed by RCA, makes possible more accurate measurement of minute vibrations.

Can a housefly make a board bounce?

Surprising though it seems, a fly—when it lands on a board—causes distinct vibrations. They can be detected by a remarkable new RCA electron tube.

Slimmer than a cigarette, and only half as long, RCA's tube picks up vibrations with a pin-sized shaft—and these vibrations may then be converted to visible or audible signals. More important, the new tube can be used to make measurements of the degree of vibration.

Scientists predict many practical uses for this *electronic transducer*. Airplane designers can hitch it to engines or whirling propellers and locate vibrations which might lead to trouble. Oil men can use it to measure the sound waves with which they scout for oil.

And your smooth-running automobile of the future may be an even better car when the facts gathered by RCA's new tube are put to work.

Another RCA "first":

The electronic transducer, first of its kind, is one of many research achievements pioneered at RCA Laboratories. Such leadership in science and engineering adds *value beyond price* to any product or service of RCA and RCA Victor.

Examples of the newest developments in radio, television and electronics can be seen at RCA Exhibition Hall, 36 West 49th St., N. Y. Admission is free. Radio Corporation of America, Radio City, N. Y. 20.



RADIO CORPORATION of AMERICA

World Leader in Radio — First in Television



TELEVISION WILL BE THERE..WILL YOU?

TELEVISION

RADIO • ELECTRONICS

OUR GREATEST OFFER IN 17 YEARS

• BULLETIN!

Fires, Sporting Events, Major happenings and other news events are being covered by Television Camera Crews in a growing number of areas. Let us show you how to prepare to enter the profitable and exciting technical phases of Television, Radio, Electronics. Mail coupon. Get Free information about our greatest offer in 17 years.

Send for FREE Information

See HOW—in your own home—DeForest's Training, Inc., now brings you one of today's most complete combinations of major home training aids. You (1) Learn-by-Seeing from D.T.I.'s exclusive instructive Home Movies. You (2) Learn-by-Reading from well-illustrated lessons. And (3), you set up your own HOME LABORATORY where you Learn-by-Doing from 16 shipments of Radio-Electronic parts which you use and KEEP to work over 300 instructive...fascinating projects. This includes building the valuable 6 tube "Superhet" RADIO and commercial-type OSCILLO-SCOPE, R-F SIGNAL GENERATOR, and Jewel-Bearing MULTIMETER, pictured at right. You may use this test equipment to help you earn real money—both in your spare time and later when working full time in the field either in a good job or your own business. Get complete facts. Mail coupon today!

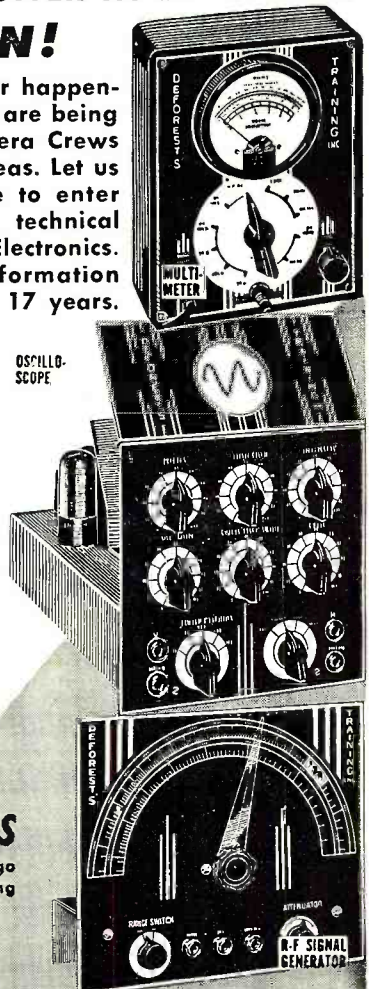

EMPLOYMENT SERVICE

When you complete your training, our effective Employment Service is available to you without extra cost—a valuable aid to help you get started.

MODERN CHICAGO LABORATORIES

If you prefer, you can get ALL your preparation in our new Chicago training laboratories—among the finest of their kind. Train quickly, using a wide variety of commercial equipment..ample instructors..every major training advantage. Write for details.

You also use HOME MOVIES!

...a D. T. I. Exclusive!... D. T. I., alone, includes the use of one of today's most effective training aids...MOVIES...to help you learn important fundamentals faster, easier at home. See electrons on the march, and other fascinating "hidden action"—a remarkable home training advantage that speeds your progress.



6-TUBE RECEIVER

YOU BUILD AND KEEP THIS EQUIPMENT TO WORK OVER 300 HOME EXPERIMENTS.

MAIL THIS OPPORTUNITY COUPON NOW!

DeForest's Training, Inc.
2533 N. Ashland Ave., Dept. RN-77
Chicago 14, Illinois

Please give me complete facts showing how I may prepare to make my start in Television-Radio-Electronics.

Name _____ Age _____
Street _____ Apt. _____
City _____ Zone _____ State _____

DeFOREST'S TRAINING, INC.
CHICAGO 14, ILLINOIS

Affiliated with the DeVry Corporation. Builders of Electronic and Movie Equipment

How to Solder Around Corners...and Between Wiring...



FLEXITIP—loop
tip easily formed.

**LONGER
REACH**—8"
from housing to
tip; gives great-
er reach.

**BUILT-IN
TRANSFORM-
ER**—compact,
complete.

SOLDERLITE—
spotlights the
work.

**5 SECOND
HEATING**—no
waiting; saves
power.

DUAL HEAT—
single heat 100
watts; dual heat
100/135 watts;
115 volts, 60
cycles.

Form the FLEXITIP on your 8" Weller Gun into any shape you want and see how it slides around corners, between wiring, into the tightest spots even when the job's buried deep.

Solderlite and 5-second heating mean hours and dollars saved—your Weller Gun will pay for itself in a few months. And because the transformer is built in—not separate—the Weller Gun is a complete, compact unit, easy to use. There's no need to unplug the gun when not in use; heat comes "on" only when the trigger is pulled.

For laboratory and maintenance work, we recommend the efficient 8" model—DX-8 with dual heat; or 4" types S-107 single heat and D-207 dual heat. Order from your distributor or write for bulletin direct.



Be sure to get your copy—**SOLDERING TIPS**, the new Weller Handy Guide to easier, faster soldering—20 pages fully illustrated. Price 10c at your distributor's or write direct.

WELLER
MANUFACTURING COMPANY
810 PACKER STREET • EASTON, PA.

For the RECORD.

BY THE EDITOR

AMATEUR radio is often taken for granted as a hobby by many and is placed on a par with such pursuits as model railroading, model shipbuilding, and photography. Those who think of ham radio in that light must not overlook the very reason for the existence of amateur radio.

Our government sanctioned amateur radio as a program that would provide for the development of advanced skills in both technical and communications phases and furnish the public with a non-commercial, voluntary communications service, particularly with respect to providing emergency communications.

The armed services have always been keenly interested in the advancement of the radio-electronic art from a communications standpoint. They know that America must depend upon a reserve of skilled personnel to handle all types of communications in periods of stress.

It is no secret to those close to the situation that the amateur has done little in past years to contribute to the technical advancement of the art. We hams have hesitated to use equipment of high efficiency and confined bandwidth, and we phone hams have ignored the use of speech clippers, filters, and other devices although they are readily available.

Again, it is no secret that many amateurs are greatly exceeding the power input limitations of 1 kw. Others have not examined the possibilities of the ultra-high frequencies for local communications and continue to use high-power rigs for local rag-chews.

Accordingly, the Federal Communications Commission has proposed new amateur regulations. On page 60 of this issue, we give a brief summary of what may come. It must be pointed out that these regulations have not, as yet, been adopted, and no action will be taken by the Commission before July 20, 1949. All interested parties have until that date to voice their opinions.

Since the announcement of these proposed regulations there has been much wailing and gnashing of teeth among amateurs. Some have gone so far as to claim that adoption of the regulations might actually mean an end to amateur radio.

After a careful examination of the proposed changes, we find little cause for alarm. It is true that present licenses must be renewed, pending the successful passing of an examination, but this should not present much difficulty to anyone who has the experience of a licensed term behind him.

It has always been the rule in ham radio that the greatest privileges go to

those hams who possess the highest qualifications. This is the logic behind these rules.

The code test will be a problem to many operators who have used phone exclusively, but in those cases a short brush-up period should restore the lost code speed without too much difficulty.

Another point that has been raised is the fear that hams will discontinue operations because of the stiffer technical requirements for phone operation on the 75- and 20-meter bands. Surely no one can have valid objections to limiting the bandwidth to that required for intelligibility. The use of a simple filter in a speech amplifier will greatly improve operations on these overcrowded bands.

To our way of thinking, the greatest benefit that will come from these new regulations, if adopted, will be the long-awaited "break" for beginners. They will be greatly encouraged by the new code requirement of five words-per-minute in straight language and will be further encouraged with the simplified examination proposed for the novice class. The possibilities of beginners creating interference will be greatly minimized by power and frequency limitations, together with the requirement for crystal control.

Amateur radio as a whole can be greatly benefited if these new regulations are approved. All of us will have to be more alert to things technical, many of us will have to brush up on our code, and we will finally be forced to employ the latest technical contributions in the transmission art.

Our country will have greater security with a more alert and aggressive backlog of trained operators. It is going to take a lot to convince many hams that these new regulations are for their own benefit. These will probably be the same ones who are opposed to "new amateur blood" in our ranks.

We are 100 per-cent in favor of any regulations designed to encourage youth to take up ham radio. We are glad to see some concrete action being taken which may serve as the missing link in this respect.

We know that our feelings are shared by some of the best technical and military brains in the country. They have seen what amateur radio can do under pressure, but they also know its limitations.

The rapid strides made in radio, television, and electronics in recent years demands that any service deserv- ing of space in the radio spectrum, should contribute its share to the use and development of frequencies which are each day becoming more in demand. We hams had better contribute our share or we will be sorry. . . O.R.

RADIO & TELEVISION NEWS

it's ALLIED for hallicrafters!



NEW

Hallicrafters S-72 All-Wave Portable Radio

Enjoy powerful all-wave reception wherever you go—with this superb new universal portable. The S-72 covers 540-1600 kc, 1500-4400 kc, 4.3-13 mc, and 12-31 mc. Receives standard broadcast programs, foreign and domestic short wave broadcasts, aircraft, police and Amateur stations. Has two built-in antennas—loop for standard broadcast and 27" whip for short wave. Automatic Noise Limiter; sensitivity control; AVC; BFO; main and fine tuning controls; tone control; phone jack; provision for attaching external antenna. Brown leatherette-covered plywood cabinet, 14" wide, 12 1/4" high, 7 1/4" deep. For 105-125 volts DC, or 60 cycle AC, or self-contained batteries. Complete with tubes, less batteries. Shpg. wt., 16 lbs.

97-505. Hallicrafters S-72 All-Wave Portable. NET..... **\$79.95**
 80-584. A-B Battery Pack for above. NET..... **\$3.85**

Available on Easy Payment Terms

Reduced Price

hallicrafters S-38 the Super-Value All-Wave Receiver



The all-star, all-wave value that amazes even the experts. Covers 4 full wave bands, continuous range from 540 kc to 32 mc. Features: full electrical bandwidth; Noise Limiter; Band Selector; BFO pitch; Voice-Code switch; Speaker-headphones switch; Standby-receive switch; latest PM speaker; In handsome furniture-steel cabinet; 12x7x8". Complete with all tubes. For 105-125 volts, 25-60 cycles AC, or 105-125 volts DC. Shipping weight, 15 lbs.

97-565. Model S-38 Receiver. Only..... **\$39.95**

TV at New Low Cost!

hallicrafters T-64 TV Chassis

Complete with
10" Picture Tube

ONLY

\$179.50

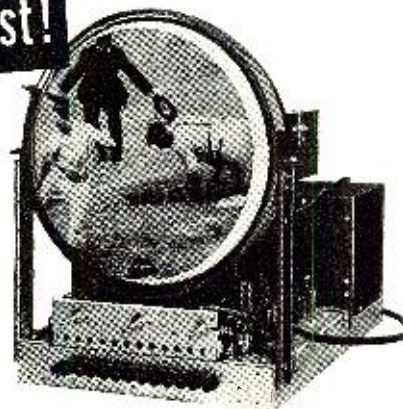

Tops for custom installations at low cost—a complete direct-view chassis for 10 or 12-inch tubes. With new Dual-Focus switch—10" tube gives you choice of big 64 sq. in. telescopic view for dramatic closeups, or large 56 sq. in. full-range view. Either way, you get a sharp picture, with fine stability and superb contrast. Features: 12 channel push-button tuning; RF amplifier; 3 IF amplifiers; 2 video amplifiers; improved sync circuits; AGC; static-free FM audio system. Complete with power supply, speaker, picture tube and 15 tubes, plus 3 rectifiers. For 105-125 volts, 50-60 cycles AC. Shpg. wt., 60 lbs.

Hallicrafters T-64 Television Chassis, complete with 10" picture tube. Only..... **\$179.50**

Hallicrafters T-64 Television Chassis, complete with 12" picture tube. Only..... **\$199.50**

Available on Easy Payment Terms

ALLIED STOCKS ALL HALLICRAFTERS MODELS

Hallicrafters SX-42 (less speaker)	\$275.00
Hallicrafters SX-62 (less speaker)	269.50
Hallicrafters SX-43 (less speaker)	189.50
Hallicrafters S-51 (complete)	149.50
Hallicrafters S-53 (complete)	89.50
Hallicrafters HT-17 Transmitter	39.50
Hallicrafters HT-18 Oscillator	110.00

All Prices Net F.O.B. Chicago

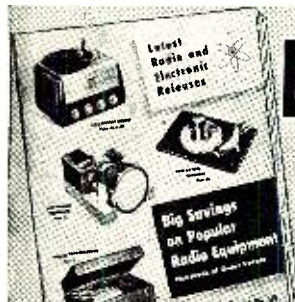

FREE Radio's Leading Buying Guide

Used by thousands of expert radio men. Get every buying advantage at ALLIED: widest selections—money-saving prices—speedy, expert shipment—personal attention—complete satisfaction on every order. Send today for your latest ALLIED Catalog.

ALLIED RADIO

ALLIED RADIO CORP., Dept. 1-G-9
833 W. Jackson Blvd., Chicago 7, Illinois

- Send FREE ALLIED Catalog
 Enter order for Hallicrafters Model.....
 Enclosed \$..... Full Payment
 Part Payment (Bal. C.O.D.)
 Send ALLIED Easy Payment details and order blank.

**FREE
CATALOG**

Name.....

Address.....

City..... Zone..... State.....

SERVICEMEN: WE'LL PROVE YOU'LL SAVE TIME AND EARN MORE WITH PHOTOFACT-

AT NO COST TO YOU!

... We'll send you absolutely

FREE

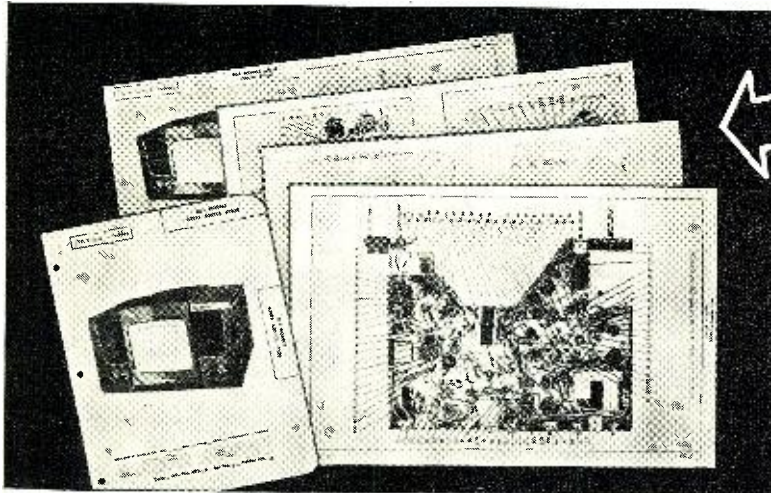

THIS PHOTOFACT FOLDER ON THE RCA 630 TELEVISION RECEIVER

OR

A PHOTOFACT FOLDER ON ANY POST-WAR AM OR FM SET OF YOUR CHOICE

(as listed in the PHOTOFACT Cumulative Index)

NOW, you can discover for yourself—at our expense—how PHOTOFACT can make your service work quicker, easier, and more profitable! Examine an actual PHOTOFACT Folder. Use it. You'll learn first-hand why this indispensable service data is used exclusively by thousands of successful service technicians. These men-in-the-know subscribe to PHOTOFACT year after year because it helps them every minute of every working day. No other serv-

ice data gives you PHOTOFACT'S outstanding advantages: *completeness, accuracy, uniformity and ease-of-use.* PHOTOFACT and *PHOTOFACT alone*, is the *only* radio service data prepared from laboratory analysis of the actual equipment it describes. Know the facts—get your FREE Folder now. Examine it—use it—compare it with others—and you will understand why no modern service shop can afford to be without PHOTOFACT.



NOTE: This FREE offer is limited to Service Technicians. Attach coupon below to your letterhead and mention the name of your jobber. If you have no letterhead, send coupon to your jobber. Experimenters and others may obtain the Photofact Folder by remitting 50c.

CURRENT PHOTOFACT BEST-SELLERS

The Recording and Reproduction of SOUND, by Oliver Read. The complete, authoritative treatment of the entire subject of Sound, written by the editor of *Radio & Television News* **\$5.00**

Photofact Television Course. The book used by thousands; gives you a clear understanding of TV principles, operation and practice **\$3.00**

Television Antennas. Shows you how to select and install the proper antenna, and how to overcome antenna problems **\$1.25**

1948 Record Changer Manual. Covers 45 models made in 1948, including new LP and dual-speed changers, plus leading wire recorders. Based on actual analysis of the equipment **\$6.75**

Auto Radio Manual. Complete Photofact service data on more than 100 post-war auto radio models—a time-and-money-saver. **\$4.95**

HOWARD W. SAMS & CO., INC. INDIANAPOLIS 1, IND.

**HOWARD W. SAMS & CO., INC.
955 N. Rural St., Indianapolis 1, Ind.**

I am a Service Technician:

- Send FREE Photofact Folder on RCA 630 TV Receiver
- Send Photofact Folder for set model.

I am an Experimenter:

- Send Photofact RCA 630 Folder. (50c enclosed)
- Send FREE Photofact Cumulative Index

Name.....

Address.....

City..... Zone..... State.....

(Offer expires Sept. 30, 1949. Good only in U. S. A.)



Relax! LET NEW HYTRON TUBE LIFTER DO THE WORK

Give your nerves, sweat glands, and fried fingers a rest! *Lift 'em* all the e-a-s-y way from meanest sockets. Tubes - GT, G, standard, metal, lock-in. Also vibrators and plugs - Jones, Amphenol. And snap-in trimounts holding back covers of radios, etc. Handy knob puller too.

Stainless steel. Comfortable rolled edges. Another Hytron time-and-money saver by and for servicemen. *Only 15¢* from Hytron jobbers. Get your Hytron Tube Lifter today.



15¢ net

SIMPLE AS ABC - Disconnect set from line. Tip tube (vibrator or plug) slightly. Insert tapered end of Lifter under base with one hand. With other, guide tube vertically. Press Lifter handle backwards or sidewise. Effortlessly, out comes tube pronto!

Right-angle end of Lifter for compact auto radios. Pulls knobs when hooked around back of knob

with thumb and forefinger steadying sides of knob.

Slotted 45-degree-angle end reaches tubes from rear of cabinet. Slot fits around one pin of lock-in applying leverage near center of metal base - safely away from glass seals. This end lifts snap-in trimounts. And stubborn knobs, if cabinet is protected from heel of angle by cardboard.

NEW HYTRON ALL-WAYS CARTON

Has type number of tube imprinted *twice* on *both* ends. Half the dual imprint (generously large, easily read) of the type number is always right side up. Stack the *All-Ways* carton any way; you can't go wrong.

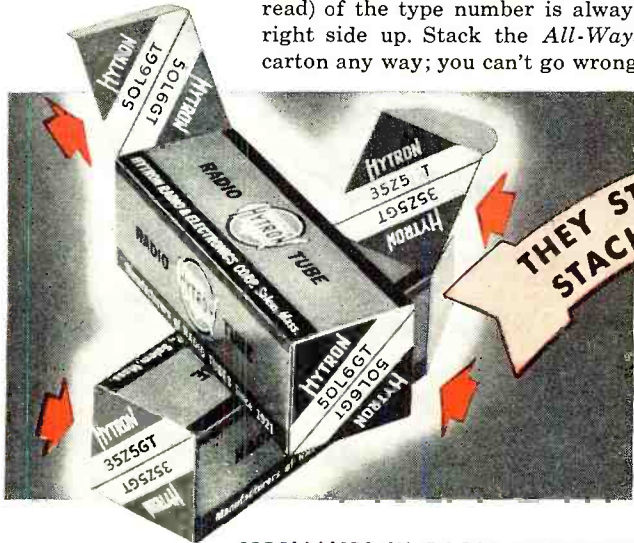

THEY STAY STACKED

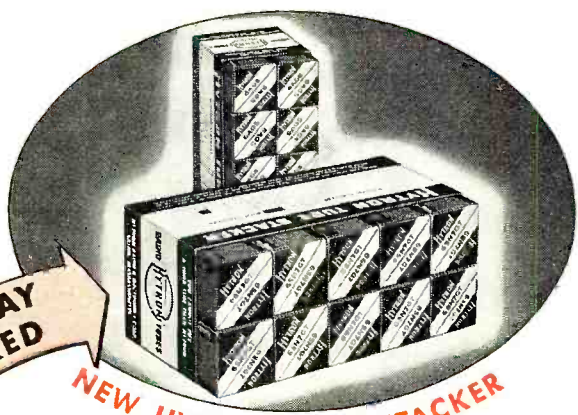

NEW HYTRON TUBE STACKER

Handy way to buy and stack tubes. Holds 10 cartons neatly - safely - compactly. Inventory where you can see it. Choice of horizontal or vertical stacking. Removal of cartons leaves shelves still neat; yet reminds you to re-order. Two Stackers: For miniatures; for GT, metal, lock-in. *Free* from your Hytron jobber.

SPECIALISTS IN RADIO RECEIVING TUBES SINCE 1921.



HYTRON

RADIO AND ELECTRONICS CORP.



MAIN OFFICE: SALEM, MASSACHUSETTS

TRANSVISION TELEVISION KITS AND INSTRUMENTS

NEW LOW PRICES

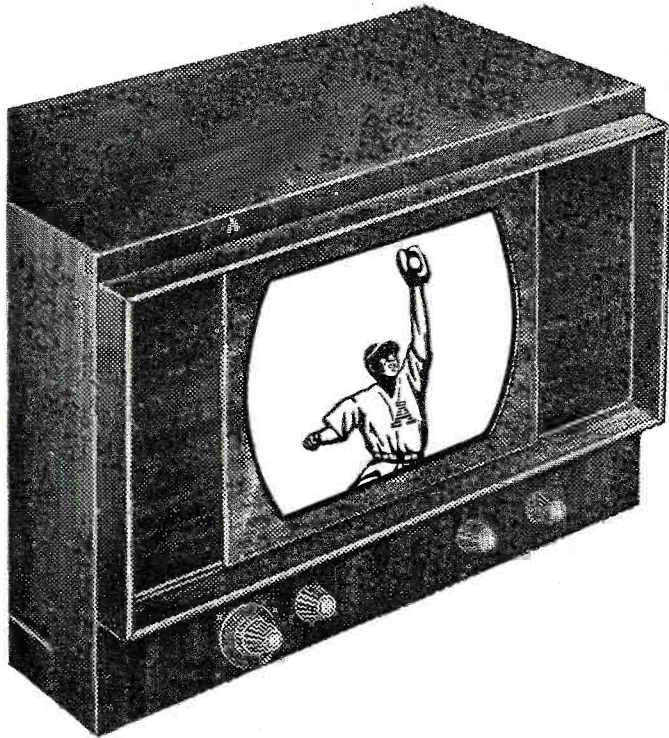

MODEL 12A-TV KIT with 12 1/2" PICTURE TUBE

- FAMOUS TRANSVISION TELEVISION KIT, giving the finest television money can buy.
- NO INSTALLATION COST. You can install assembled kit yourself in about an hour.

\$179⁰⁰

less cabinet*

NEW! TRANSVISION Model W15RS TV KIT

SEMI-WIRED and ALIGNED

Can be completed in one day!

This high-quality Transvision TV Kit has

\$219 Less Cabinet*

a 16" picture tube.

***CHOICE of BEAUTIFUL CABINETS from \$29**

For example, a "Modular" Console Cabinet, which can easily be assembled in about an hour, costs \$29.

ELIMINATE the VARIABLES in TELEVISION Installation with the TRANSVISION FIELD STRENGTH METER

Improves Installations! Saves 1/2 the Work!!

Has numerous features and advantages, including — (1) Measures actual picture signal strength . . . (2) Permits actual picture signal measurements without the use of a complete television set . . . (3) Antenna orientation can be done exactly . . . (4) Measures losses or gain of various antenna and lead-in combinations . . . (5) Useful for checking receiver radiation (local oscillator) . . . (6) **12 CHANNEL SE-**



LECTOR . . . (7) Amplitudes of interfering signals can be checked . . . (8) Weighs only 5 lbs. . . (9) **Individually calibrated** . . . (10) Housed in attractive metal carrying case . . . (11) Initial cost of this unit is covered after only 3 or 4 installations . . . (12) Operates on 110V, 60 Cycles, A.C. Model FSM-1, with tubes . . . new law price . . . Net **\$79⁵⁰**

200 Sq. In. PICTURE TV-FM KIT MODEL 12CL

Has DuMont Inputuner

IMAGE IS EQUAL to that of a 90" tube—even sharper and clearer—visible from all angles.

EQUIVALENT OF \$1000 SETS!

Price of the new Transvision 12CL electromagnetic kit includes these outstanding features:

• 12 1/2" picture tube with special fitted built-in All-Angle Lens and color kit.

• DuMont TV-FM Inputuner

• Streamlined Console Cabinet

Includes Cabinet, Lens, Indoor or Outdoor Antenna, 60 ft. of Lead-In Wire.

\$329

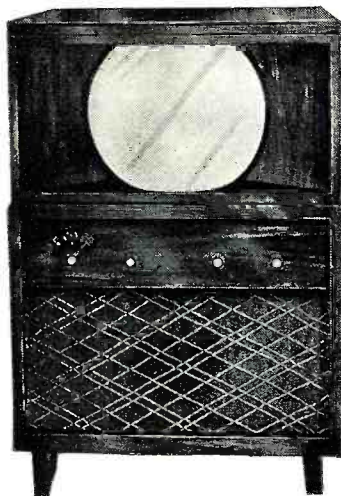

MODEL 12CL TV-FM KIT

TRANSVISION, INC., Dept. RN, NEW ROCHELLE, N. Y.

All Transvision Prices are fair traded; subject to change without notice. Prices 5% higher west of the Mississippi.

For FREE 20-page TV BOOKLET and CATALOG SHEETS, SEE YOUR TRANSVISION OUTLET!

NEW YORK, N. Y.
TRANSVISION OF MANHATTAN
75 Church St.

BRONX, N. Y.
TRANSVISION OF THE BRONX
1425 Boscobel Ave.

BROOKLYN, N. Y.
TRANSVISION OF BROOKLYN
485 Coney Island Ave.

LONG ISLAND, N. Y.
TRANSVISION OF LONG ISLAND
167-01 Hillside Ave.
Jamaica, N.Y.

WESTCHESTER, N. Y.
TRANSVISION OF WESTCHESTER
606 Central Park Ave., Yonkers, N. Y.

NEWARK, N. J.
TRANSVISION OF NEW JERSEY
601 Broad St.

PHILADELPHIA, PA.
TRANSVISION OF PHILADELPHIA
235 North Broad St.

BOSTON, MASS.
TRANSVISION OF NEW ENGLAND
1306 Boylston St.

BALTIMORE, MD.
TELEVISION CENTRE, INC.
1912 North Charles St.

CINCINNATI, OHIO
TRANSVISION OF CINCINNATI
Fourth and Plum Sts.

CLEVELAND, OHIO
TRANSVISION OF CLEVELAND
2001 Euclid Ave.

COLUMBUS, OHIO
TRANSVISION OF COLUMBUS
53 W. Norwich Ave.

CHICAGO, ILL.
TRANSVISION OF CHICAGO
1002 South Michigan Ave.

SYRACUSE, N. Y.
TRANSVISION OF SYRACUSE
622 North Salina St.

MIAMI, FLA.
TRANSVISION OF FLORIDA
42 Southeast Eighth St.

DALLAS, TEX.
TRANSVISION OF TEXAS
700 Commerce St.

HOLLYWOOD, CALIF.
TRANSVISION OF CALIFORNIA
8572 Santa Monica Blvd.

SAN FRANCISCO, CALIF.
TRANSVISION OF CALIFORNIA
3471 California St.

CANADA
TRANSVISION-TELEVISION LTD.
465 Church St., Toronto, Ontario

Eleven

NEW MODELS

FIVE NEW 7" MODELS

P7-T	ST-804	P7-T	ST-807
P7-U	ST-806	F7-T	ST-809
	F7-U	ST-808	

FIVE NEW 6"x9" OVAL MODELS

P69-S	ST-812	P69-T	ST-811
P69-V	ST-810	F69-T	ST-814
	F69-U	ST-813	

ONE NEW 5 1/4" MODEL

P525-V	ST-803
--------	--------

The addition of these new models brings the number of speakers in the Jensen Standard Series to fifty-three — the most complete array in speaker history. In addition are the Jensen Concert Series, Special Series, Coaxial, and Professional Series. There is a genuine Jensen available for every purpose.

Write for Catalog 1010-F

Jensen

MANUFACTURING COMPANY

Division of the Muter Company

6617 SOUTH LARAMIE AVENUE
CHICAGO 38, ILLINOIS

In Canada: Copper Wire Products, Ltd., 351 Carlaw Ave., Toronto

MERIT

news

NOW! MORE

MERIT

VIBRATOR
TRANSFORMERS

Ford—General Motors—Motorola—Philco

—EQUALS—

First to give you exact replacement vibrator transformers for all popular auto radios. Dependable, top quality reproduction of characteristics and performance specified by manufacturers. Merit's faithful design and engineering assure quick, easy mountings. Potted in steel cans. Include built-in filter choke and condenser where required.

ADD THEM TO YOUR MERIT STOCK TODAY

MERIT VIBRATOR TRANSFORMER EQUALS

Type No.	List	D.C. Volts to filter	Secondary MA
P3068	\$4.50	250	60
P4076	5.60	265	55
P4077	6.00	280	65
P4078	7.00	270	60
P4069	6.75	150	40
P4070	7.25	225	40
P4071	7.50	250	50

Type No.	H	W	D	Mounting
P3068	2 3/4"	2 3/8"	1 7/8"	C
P4076	3 1/4"	2 3/8"	2 3/8"	JG
P4077	3 1 1/2"	2 1/4"	2 3/8"	JT
P4078	2 5/8"	2 3/8"	2 3/4"	JT
P4069	3"	2 3/8"	2 3/8"	JT
P4070	3"	2 3/8"	2 3/8"	JT
P4071	3"	2 3/8"	2 3/8"	JT

For complete listing of replacements—see Howard W. Sam's Red Book, Photofacts and New Auto Radio Manual AR-1 (auto replacement transformer section).

All catalog items in stock.

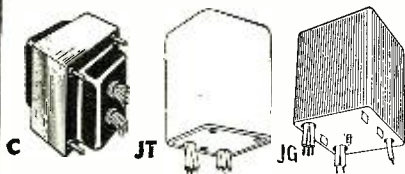

PRODUCTS OF MERIT



ANNIVERSARY
25

MERIT

COIL & TRANSFORMER CORP.

4437 NORTH CLARK ST., CHICAGO 40, ILL.

Spot Radio News

★ Presenting latest information on the Radio Industry.

By RADIO & TELEVISION NEWS'

WASHINGTON EDITOR

TV CONTINUES to serve as a keynote in addresses by leading members of industry and government, particularly FCC Chairman Wayne Coy. The spokesman for the Commission, who has become the radio industry's best good-will ambassador, showered plaudits on the might of television during his round of talks around the country in the late spring and early summer months.

In New York before the Rotary Club, Coy quoted TV as the . . . "most powerful and most versatile medium ever developed for the communication of ideas, for the dissemination of information, education, culture, and entertainment."

Describing TV as a "revolutionary new type of broadcasting," he said that . . . "by speeding our industrial processes, by facilitating our merchandising methods, by stimulating and informing the mass of our population, this electronic miracle will raise our American standard of living to new heights."

Analyzing the progress achieved by TV, the chairman said that four years ago we had only seven stations on the air, and today we have sixty operating, and as many more under construction. He pointed out that within the next two years, there will be one or more TV stations in every one of the nation's 140 major market areas, and that by the end of 1951, there will be close to 400 stations on the air.

Then Coy went on to detail the attitude of the listeners to TV, saying that . . . "the American people have taken this new art to their heart with such enthusiasm that they have dug down in their pockets and purchased more than a half-billion dollars worth of sets. They are, in fact, buying the sets as fast as they roll off the assembly lines. Industry leaders estimate that by the end of this year there will be 3,000,000 sets produced, and that by the end of 1952 there will be sets in 17,000,000 homes, or half the homes in the nation."

Describing the feelings of advertisers for TV, Coy declared that . . . "we were told by some that television was so costly that few advertisers would be able to afford it. Yet today more than a thousand advertisers are using television. Moreover, it is now becoming increasingly evident that be-

cause of its effectiveness, television advertising may prove to be the cheapest form of advertising, cheapest when measured by sale made per advertising dollar invested."

Although building a television station is an expensive business, the FCC headman said that the Commission has far more demands for channels than it can supply, and . . . "we need more channels for more stations. We have been working for months with the foremost experts in the matter to resolve the technical problems involved. I am hopeful that we can find the solution in the very near future."

In another television progress talk, this time before the *Institute for Education by Radio*, at Columbus, Ohio, Coy predicted that . . . "five years from now most Americans will be getting most of their broadcast information, education, and entertainment from television, and five years from now, 40 per-cent to 50 per-cent of the homes in America will have television receivers."

Coy's enthusiasm for TV has alerted many in industry to his potential virtues as a leader for the art, perhaps as prexy of an industry association like the Television Broadcasters Association. There have been conferences within the TBA to study the possibility. It has been reported that Dr. Allen D. DuMont, first TBA president, was strongly in favor of Coy, if he was available, with quite a substantial salary as an incentive to join the group, perhaps up to three times as much as Uncle Sam is paying now.

THE POSSIBILITY that Coy might accept an industry appointment appeared in his FCC budget report to Congress, in which he declared that he has had to dig into his savings on many occasions to pay for expenses incurred during government trips. Expanding this point, he said . . . "my present salary as a member of the Commission does not meet my personal living expenses, and my resources are inadequate to continue for any great length of time the expenditure of personal savings in order to maintain myself and my family."

FCC salary-increase bills have been introduced, providing boosts of \$2000 to \$5000 for each commissioner, in the hope that such increases would keep

RADIO & TELEVISION NEWS

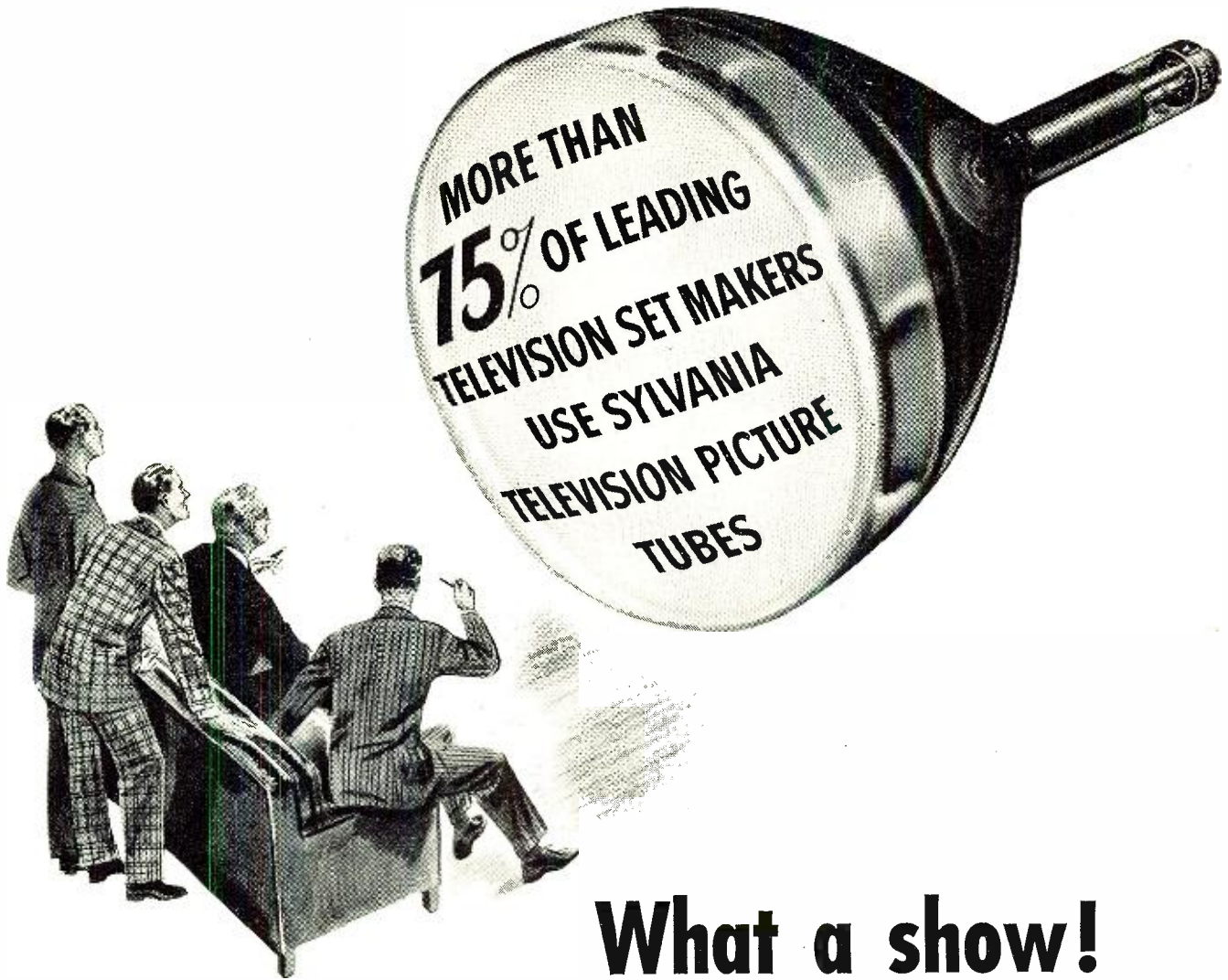

What a show!

A recent intensive survey discloses that among the major television set manufacturers, more than 75% use Sylvania cathode ray tubes!

This impressive showing is a tribute to the research and quality production techniques employed by Sylvania in the making of picture tubes that are unsurpassed.

If you wish full information about the entire Sylvania line of television picture tubes made by the manufacturers of highest quality radio tubes and electronic equipment, write Sylvania Electric Products, Inc., Cathode Ray Division, Emporium, Pa.

These leading television set manufacturers use Sylvania Television Picture Tubes

Admiral • Air King • Andrea • Ansley • Automatic
 Bendix • Crosley • DeWald • Emerson • Fada
 Farnsworth • Garod • Hallicrafters • Hoffman
 Magnavox • Midwest • Motorola • National • Olympic
 Packard-Bell • Philco • Pilot • Raytheon-Belmont
 Regal • Scott • Sentinel • Silvertone • Sperton
 Stromberg-Carlson • Tele-King • Tele-tone • Temple
 Trav-ler • Westinghouse • Zenith

SYLVANIA ELECTRIC

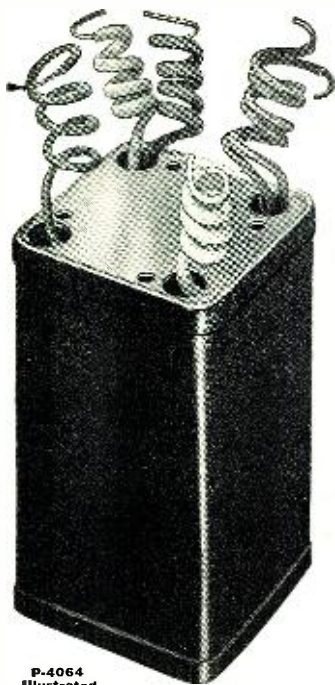

P-4064 Illustrated

Now Available!

**STANCOR
Exact Duplicate
AUTO RADIO
VIBRATOR
TRANSFORMERS**

RADIO technicians servicing automobile radios need EXACT replacements. Now Stancor offers you replacement vibrator transformers specifically designed to provide the EXACT electrical and physical duplicate for most popular models of auto radios—as listed in the following table. Every unit carries the RMA guarantee and meets the regular Stancor requirements of quality workmanship and superior performance. Don't take a chance on a "universal" replacement! Insist on Stancor EXACT Duplicate replacements and be sure. Your Stancor distributor has these units in stock for immediate delivery.

JUST PUBLISHED!

Write For The New Stancor Transformer Catalog Listing Over 400 Replacement Items.

Stancor Part No.	Trade Name	Manufacturer's Part Number	Description	Year
P-4064	United Motors (Delco)	7240519	Buick	1946-47
P-4065	United Motors (Delco)	7255881	Cadillac, Chev., Olds., Pontiac	1946-47
P-6470	Regal (5-tube Univ. Series)	140-111	140 V. @ 50 Ma. 2-11/16" H x 2-11/16" W x 2-3/32" D	1946-47
P-6471	Motorola (408, 508, 608)	25B472533	6 tube Ford	1946-47
P-6472	Colonial-Detrola No. 8072 Colonial-Bendix MI Colonial-Motorola Motorola (405, 505, 605, 705)	D 71014	Ford 8A-18805-A	1947-48
		C 217020	Ford 8A-18805-A	1947-48
		C 71014	Ford-FD6, Nash Standard	1947-48
		25B70950	Standard	1947-48
P-6473	Zenith	95-1073	Ford, Mercury, Lincoln (8-tube)	1947-48
P-6474	Zenith	95-1066	Hudson	1947-48
P-6476	Colonial-Detrola No. 7070 Colonial-Motorola-Detrola No. 8030	D 70267	Ford No. 51A-18805-B2	1947-48
		C 70267	Wifflys No. 67077	1947-48



STANDARD TRANSFORMER CORPORATION
ELSTON, KEDZIE & ADDISON • CHICAGO 18, ILLINOIS

the men in the Capitol. There were doubts whether these increases would be sufficient to hold the chairman and one or two others to their desks at the New Post Office Building, where the officials preside.

No decision on the part of the chairman is expected for many weeks, since he is scheduled to appear at several pertinent international meetings, the first one in Paris as leader of the American delegation to the International Telegraph and Telephone Conference.

NILES TRAMMELL, NBC prexy, echoed Wayne Coy's deep interest in TV, in an address before the convention of the American Newspapers Association, when he cited the progress made by the video art in its short life, in comparison to other industries. For instance, autos and refrigerators were substantially behind in unit sales and are expected to fall behind even more, during the TV spiral, the broadcast network headman reported.

Trammell also showed that in the early spring there were 1,356,200 sets installed in the ten top cities, with 600,000 in New York, 165,000 in Philadelphia, 126,000 in Los Angeles, 145,000 in Chicago, 81,600 in Boston, 57,700 in Baltimore, 55,500 in Detroit, 44,400 in Washington, 52,000 in Cleveland, and 29,000 in St. Louis.

Additional figures presented disclosed that TV now blankets over 42 per-cent of the nation's families, and around 60,000,000 people are living within service range of TV transmitters. Quite an audience!

AN ULTRA-HIGH plan which could be set up immediately and uses but 10 per-cent of the ultra-high band was described a few weeks ago before the FCC by James A. McKenna, Jr., who offered the plan on behalf of his client, the *Helm Coal Co.*, operator of WN-OW and WNOW-FM, York, Pa., who is seeking Channel 8 for TV.

In the McKenna plan, six channels in the 475-890 mc. band would be spotted in about thirty cities which are not adequately provided for in the present very-high allocations. This approach, McKenna pointed out, would begin to provide the extra channels so urgently needed now, permit the use of the present very-high standards and allow simple converters for pick-up work. Others saw the plan as an answer to the ultra-high test problems now worrying the FCC and industry committees. For with these stations in operation it would be possible to compile invaluable propagation data and other pertinent transmission information now being sought.

THE BRIDGEPORT, Conn., area will soon be the first ultra-high-satellite-station test site, when NBC's 529 mc. transmitter goes on the air. The station, which is expected to radiate about 15 kilowatts, will pick up WN-BT programs from New York and re-

(Continued on page 111)

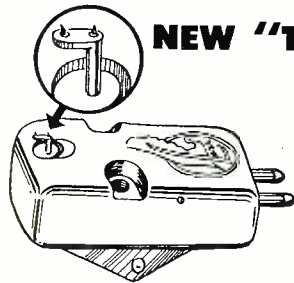

**NEW "TANDEM NEEDLE" CARTRIDGE
FOR 2 SPEED CHANGERS**

Lear announces the Model MP107 "Tandem needle" variable reluctance cartridge for high fidelity in Webster 246 and 256 changers, and other arms.

- 1 Response \pm 2db 50 to 10,000 cycles.
- 2 Tracks with lowest recommended stylus force.
- 3 One mil and 3 mil retractable sapphire stylii.
- 4 Standard Lear "knee action" stylus suspension.
- 5 Easily installed without special tools.

OUTSTANDING FEATURES



LEAR, INCORPORATED
11916 West Pico Blvd., Los Angeles 34, California

The Success Story of Bill Smith... OR YOU!



Mails coupon to National Schools in Los Angeles, and receives Free Lesson and book of Information about Radio, Television and Electronics training.



Enrolls... studies in spare time. Finds personal attention from instructors, interesting material and practical equipment, all increase his interest.



Builds actual units as part of Course. Earns money doing spare time repair and installation work.

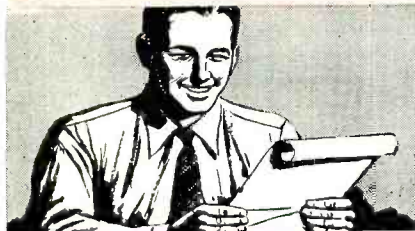

Completes Course and receives Diploma... is now a qualified Radio, Television and Electronics Technician.



Applies for—and GETS—a good pay, full time job in industry. Finds that employers know National Schools and like to hire their graduates.



Or he opens own profitable Service Shop, with valuable counsel and aid from National Schools. Now for real happiness and success!



You Build This Superheterodyne Receiver With Parts We Send

You receive complete standard equipment, including latest type High-Mu Tubes, for building various experimental and test units. You progress step by step until you build a complete Superheterodyne Receiver. It is yours to use and keep.

Professional Multitester Included!

This portable instrument (see right) enables you to perform many practical tests, make delicate adjustments and do service work. Complete with test leads.

You receive a series of special laboratory experiment lessons to guide your practical exercises with your equipment. These lessons have been prepared with a special technique of illustrating radio principles by numerous easy-to-understand examples.

Both Resident and Home Study Courses Offered

Send Coupon Today for These Two Valuable Free Books

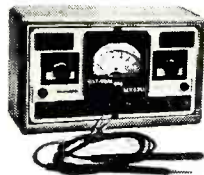

GET INTO RADIO, TELEVISION and ELECTRONICS by NATIONAL SCHOOLS SHOP METHOD HOME TRAINING

THIS PRACTICAL, TECHNICAL RESIDENT TRADE SCHOOL TRAINS YOU AT HOME FOR BIG RADIO OPPORTUNITIES!

Never in history has such rapid progress been made as in the great Radio, Television and Electronics Industry today! This exciting, fast-moving development means new and greater opportunities for the trained, skilled man—for you—in Television and Radio Broadcasting, Installing, Servicing; in Frequency Modulation; in Applied Electronics in many industries; in a business of your own!

National Home Training is Practical

Your National Schools Course fully covers basic, advanced and specialized instruction in all phases, including basic radio principles, receivers, am-

plifier systems, transmitters, television, aviation radio, electronics. You get complete instruction material, including shop manual, tube manual, job sheets, radio dictionary, special laboratory experiment lessons, experimental equipment. You receive complete, modern television lesson texts.

Your Home Study is supervised by our staff of highly trained instructors who daily teach our resident students here. Let the Free Books shown below tell you more about National Home Training. Use coupon today!

APPROVED FOR VETERANS

NATIONAL SCHOOLS

LOS ANGELES 37, CALIF. • EST. 1905



FIND OUT NOW... MAIL COUPON TODAY

National Schools, Dept. 7-RN (Mail in envelope or paste on postcard)
4000 South Figueroa Street
Los Angeles 37, California

Mail me FREE the book, "Your Future in Radio," and a sample lesson of your course.

NAME..... AGE.....

ADDRESS.....

CITY..... ZONE..... STATE.....

Check here if veteran of World War II



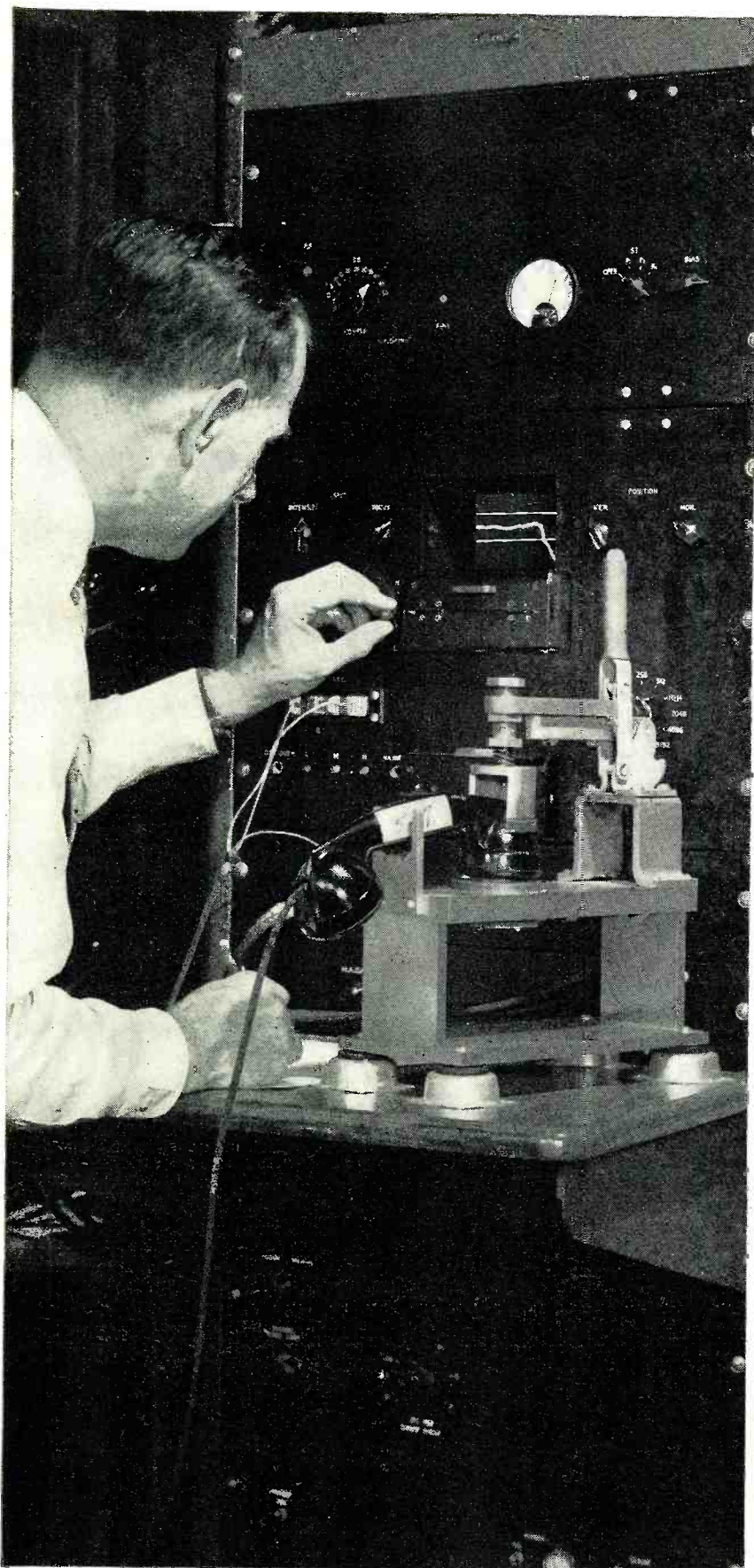

YOUR telephone receiver should treat each tone in the voice alike; that is important to you, because proper balance makes pleasant listening and easy understanding. Naturalness in receiver performance is pictured in a matter of seconds by the apparatus shown at left.

The receiver is clamped in place and an oscillator feeds into it frequencies representing all talking tones. Then a bright spot darts across an oscilloscope screen leav-

**It listens so
YOU
can hear better**

ing behind it a luminous line which shows instantly the receiver's response at each frequency. It is precise; and it is many times faster than the old method of measuring receiver performance point-by-point and then plotting a curve.

At Bell Laboratories, development of techniques to save *time* parallels the search for better *methods*. For each time an operation is made faster, men are freed to turn to other phases of the Laboratories' continuing job — making your telephone system better and easier for you to use each year.



BELL TELEPHONE LABORATORIES

EXPLORING AND INVENTING, DEVISING AND PERFECTING, FOR CONTINUED IMPROVEMENTS AND ECONOMIES IN TELEPHONE SERVICE.

RADIO & TELEVISION NEWS

JULY, 1949

**RADIO
& TELEVISION
NEWS**

RADIO-ELECTRONIC

Engineering

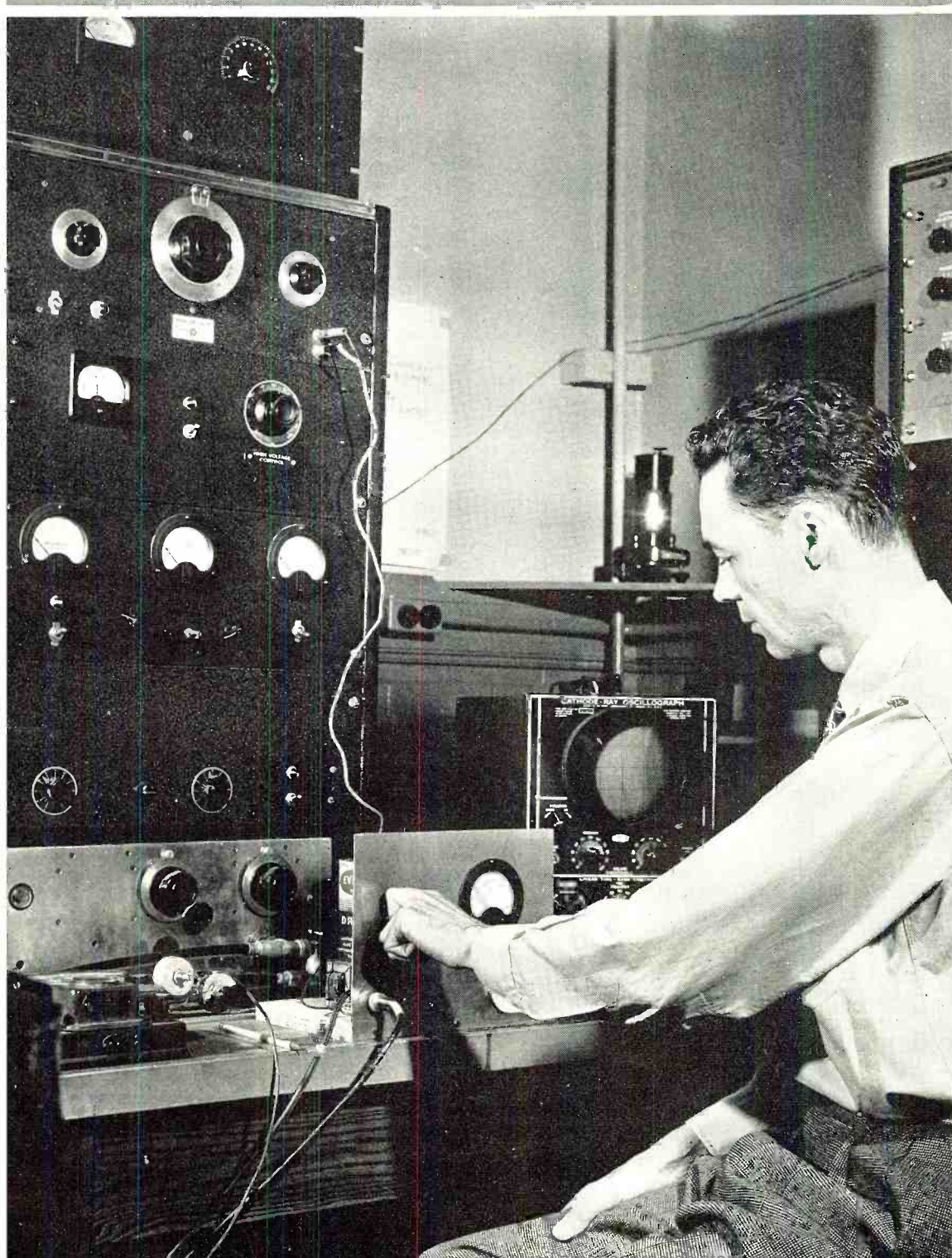

TELEVISION

RADAR

ELECTRONICS

RESEARCH

COMMUNICATIONS

MAINTENANCE

RADIO-ELECTRONIC

Engineering

Trade, M. & Registered U.S. Patent Office No. 225547

ELECTRONICS • COMMUNICATIONS • TELEVISION • RESEARCH • MAINTENANCE

JULY, 1949

MEASUREMENT OF QUALITY IN AUDIO REPRODUCTION...David Fidelman	3
HIGH-RATIO MULTIVIBRATOR FREQUENCY DIVIDER.....Martin Silver	7
SUBMINIATURE DECADE COUNTER.....W. W. Snyder	10
CAPACITANCE METHOD OF MEASURING WEAR.....	11
SOUND MIXER FOR TV FILM RECORDING.....John B. Ledbetter	12
ELECTROMECHANICAL PHASE INDICATOR.....Sidney Wald	14
BROADBAND BOLOMETRIC MEASUREMENT OF MICROWAVE POWER.....Herbert J. Carlin	16

DEPARTMENTS

NEW TUBES.....	20	NEW PRODUCTS.....	24
NEWS BRIEFS.....	22	TECHNICAL BOOKS.....	25
PERSONALS	27		



RADIO-ELECTRONIC ENGINEERING is published each month as a special edition in a limited number of copies of RADIO & TELEVISION NEWS, by the Ziff-Davis Publishing Company, 185 N. Wabash Avenue, Chicago 1, Illinois.

VOLUME 13, NUMBER 1, Copyright, 1949, Ziff-Davis Publishing Company

COVER PHOTO—Courtesy of National Bureau of Standards

Electronic control and measuring circuits used in nuclear magnetic resonance measurements at the National Bureau of Standards. The cabinet at left contains an audio oscillator, power supplies, and a 20 mc. generator. Dr. H. A. Thomas is shown adjusting the magnetic field to produce resonance in a proton sample.



MEASUREMENT of QUALITY

By DAVID FIDELMAN

ALMOST since the earliest days when it was possible to reproduce the human voice and music with reasonable accuracy, the question arose as to what was most to be desired in the reproduction of sound and what basis to use for judging the results. This question has been the subject of considerable controversy, and various observers at different times have found widely conflicting results in attempting to obtain quantitative data which would represent the best type of audio reproduction. Closely tied in with this is the additional question of whether the electronic engineer is justified in using the means at his command to improve what he may feel are faults in the original sound. With all the progress that has been made in techniques and methods of sound reproduction, these are still live issues today, and occupy a good deal of the audio engineer's attention.

All tests to determine quality of sound reproduction are based essentially upon the human ear as the standard measuring instrument, with the listener indicating which of several types of reproduction he prefers. If a sufficiently large number of listeners is used, individual errors and psychological effects tend to cancel out on a statistical basis. According to this testing procedure the preference of the greatest number of listeners represents the best type of reproduction under test. This is a perfectly logical and reasonable method of testing for sound quality, since public acceptance is the ultimate criterion of any type of sound or auditory stimulus.

However, great care must be taken in performing such tests, in order to obtain proper control of the measurement variables to insure that misleading results are not obtained. This factor is of especial importance in listener-preference tests, because they involve a wide variety of listening conditions and a large sampling of individuals, and the results depend upon many variable factors.

Earliest measurements tended to indicate that the average listener preferred reproduction having a restricted frequency range, rather than wide-range reproduction. This result was taken as the explanation of why most radio receivers in the home are found to have the tone-control knob set for minimum high-frequency response, and seemed to justify the manufacturers

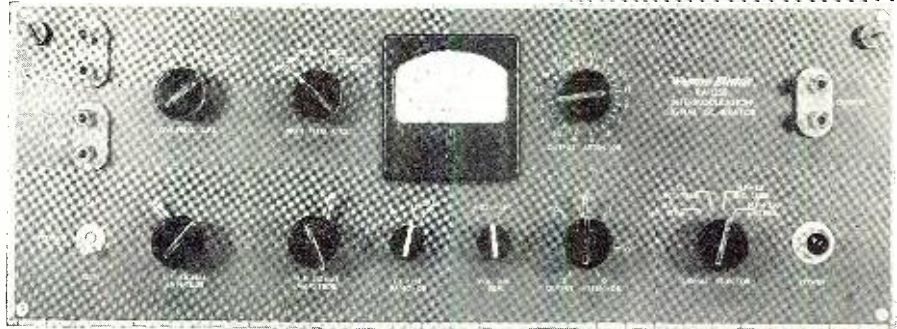

Front panel of RA-1258 intermodulation signal generator, to be used with the intermodulation analyzer shown on p. 5.

in AUDIO REPRODUCTION

Part I of a 3-part article describing the various types of audio distortion and how they are measured.

who designed their receivers with practically no response above 5000 cycles. However, later investigations indicate that this conclusion is not valid from the data upon which it is based. A large number of variables were left uncontrolled, and quite different results would have been obtained if they had been taken into account.

In the most recent listener-preference tests, much greater care has been taken to control accurately all the variables which are not under test. For example, a recent test was performed to test for frequency-range preference, in which all factors but frequency range were rigidly controlled. The sound was produced by a live orchestra in the same

room with the listeners, but hidden behind a curtain and separated from them by a variable acoustic filter. When the test is properly set up in this manner, no other conditions of reproduction of sound enter into the measurement since the audience hears the sound of the orchestra directly. The only variable is the high-frequency response which is controlled by the acoustic filter.

From such tests, as well as from others in which proper precautions were taken to eliminate the various spurious uncontrolled factors, results show that in the absence of other disturbing factors the listener prefers the widest frequency range in reproduction of speech and music.

These findings confirm the audio engineer's intuitive opinion—that the best type of sound reproduction is that in which the listener hears as nearly as possible an exact reproduction of the original sound. In other words, it is not the engineer's task to attempt to improve on the sound of musical instruments (for example, by making it sound like "juke box" reproduction).

A comparative study of the results of the various listener-preference investigations indicates that frequency-range is only one of the important factors in

Fig. 1. Basic theory of measurement consists of applying a standard test signal to the input of the system and measuring the resulting response into a normal load.

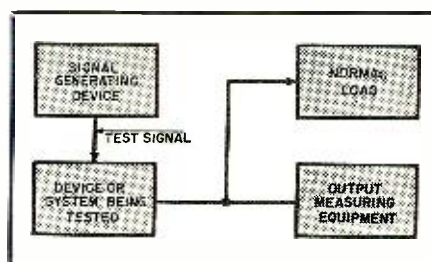

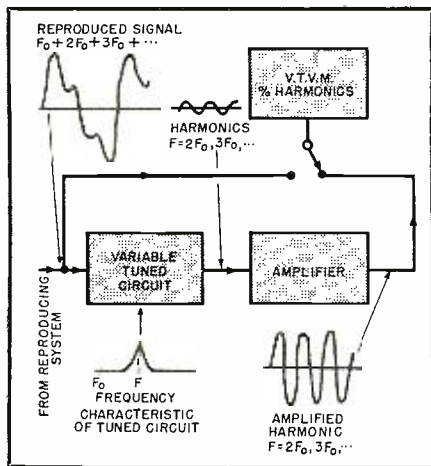

Fig. 2. Wave analyzer method of measuring each individual harmonic by using a variable tuned circuit instead of the rejection filter of Fig. 3.

the reproduction of sound. A number of other factors are involved, some of which may be considerably more important than frequency range in determining the acceptability and fidelity of reproduction. What these factors are, how they affect the quality of reproduction, and how they can properly be evaluated, will be discussed in the following sections of this article.

General Techniques of Audio Measurements

Any type of measurement consists essentially of causing the system under test to perform its function under controlled conditions, and to measure the success with which it performs this function. The accuracy of the measurement is determined by the degree to which the input test signal represents or simulates the true operating condition, and by the accuracy with which the operation of the system and the relevant variables can be measured.

When applying this principle to the

testing of sound and audio reproducing systems of any type, a true test would mean the measurement of the fidelity with which complex sounds such as speech and music are reproduced. The most basic audio test attempts to do this—a sound is applied to the input of the system, and the reproduced sound is measured by using the ear as the measuring instrument. This test is actually the criterion in determining most purchases of audio equipment, but it is completely subjective and is not capable of accurate quantitative measurements for scientific and engineering purposes.

For accurate measurements the average sound is much too complex a function to permit a ready determination of its characteristics. It is therefore necessary to simulate sound by simpler types of signals which are capable of direct measurement and which simulate the characteristics of the sounds which are of interest. The complete testing of an audio system requires measurements on several different types of input signals, in order to represent accurately the various factors known to be important in determining the quality of reproduction of a complex sound. Some of these measurements require the use of a single steady sine wave, others require two such sine waves of different frequencies, while still other tests require the use of more complex signals having certain transient characteristics similar to those occurring in natural sounds. By using such simplified signals which can be generated and measured fairly easily, the more complex relationships which occur in sound are separated and simplified into a form capable of exact measurement. Proper correlation of these simplified measurements will then give an indication of the extent to which the system under measurement can reproduce complex sounds.

When carrying out such measure-

ments in practice, the tests can in general be performed either over the complete system or for any individual sub-component of the system. For example, the measurements may be performed over-all from microphone to loudspeaker, or over any individual phase of the system such as the amplifier, the phonograph pickup, the loudspeaker, etc. The over-all measurement has the advantage that it measures the interactions as well as the characteristics of the individual components, and gives an indication of the complete reproduction quality. However, the method of individual measurements has the advantage of being generally simpler and more convenient to perform, and serves to localize any deficiencies which may exist. With this method each component should be carefully matched into the proper input and output impedances, to approximate as closely as possible its interactions with the over-all system. Then the over-all quality can be obtained by correlation of the individual measurements.

The basic setup for any type of measurement is shown in Fig. 1. A known input of the proper form is applied through a generator of the desired impedance to the input of the system, and the resulting output is measured across the desired load impedance. Each different type of audio unit will, of course, require the correct type of input signal and the output must be measured by the proper type of measuring instrument. A listing of all the various types of audio units which it may at times be necessary to test is given in Table I. This table represents an over-all picture of the general techniques of audio measurements.

Great care must also be given, in performing any measurements whatever, to the selection and characteristics of the test equipment itself. All equipment and instruments used for the measurements must be sufficiently better than the system under test so that their defects can reasonably be neglected. This factor should always be given careful consideration, and if any auxiliary equipment must be used in making a particular measurement or set of tests, precautions should be taken that the equipment used should not introduce errors which might be large enough to make the readings unreliable or meaningless.

General Problem of Audio Quality

An indication of the various factors which determine the quality of audio reproduction can be obtained from an analysis of the many listener-preference tests which have been performed. Close study of the manner in which some of the tests have been performed, and of different effects which were considered

Fig. 3. General method of measuring the total harmonic distortion introduced by the reproducing system.

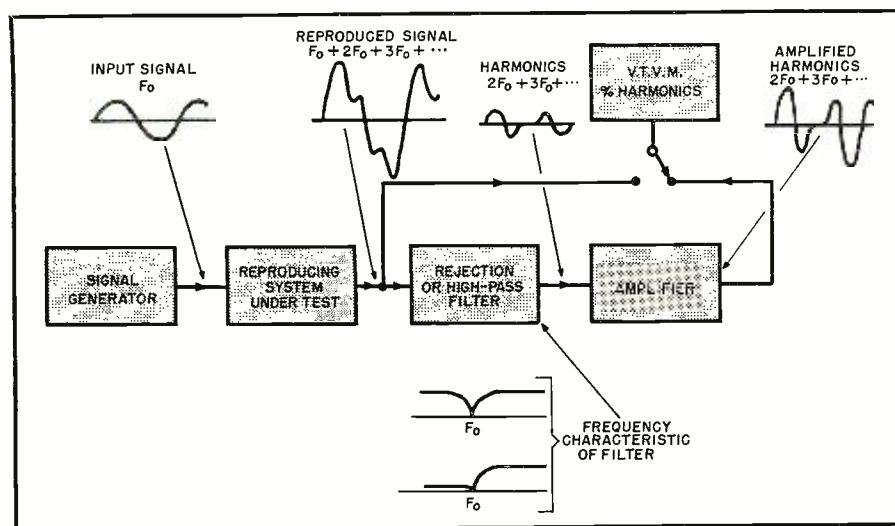

in some cases and not in others, points to a number of distortions in the reproducing equipment that are extremely important in determining the quality of the reproduction. Certain of these distortions are much more distasteful to the ear than restricted frequency range, and when they are present the listener prefers the restricted range in order to reduce their effects. (This factor explains the results of some of the earliest tests in which listeners were found to prefer narrow-band reproduction, since in these tests no attempts were made to remove the various forms of distortion which were related to the frequency range.)

The measure of quality of reproduction by any audio system must therefore take into account all forms of distortion of the original sound by the system. Certain of these (frequency response, amplitude non-linearity, and noise) have long been known and used as a measure of fidelity of reproduction. However, it is now known that such a measurement must include other factors, and can be quite erroneous if based only upon these three factors. Thus, a complete specification of the quality of any system should include accurate information about *each* of the following types of distortion which are at the present time known to have an important effect on the final reproduced sound:

- (a) Frequency-amplitude distortion
- (b) Harmonic distortion
- (c) Intermodulation distortion
- (d) Transient distortion
- (e) Phase distortion
- (f) Frequency modulation distortion (wow and flutter)

These types of distortion are capable of measurement and analysis in any audio reproduction system. There are, of course, certain other fundamental limitations which are present in any attempt to reproduce sound:

- (g) Differences in acoustics between the room in which the sound originates and the room in which it is reproduced
- (h) Spatial distribution effects
- (i) Limited dynamic range in reproduction

However, these last three are not strictly defects of the audio system,

since they are inherent in any attempt to reproduce natural sounds from one place to another. Efforts have been made to correct for spatial distribution and dynamic range errors by means of multi-channel systems for the reproduction of auditory perspective, and volume expanders for increased dynamic range.

For accurate and faithful reproduction of any sound, the various distortions which have been described above should be kept below the level at which their effects can be detected by the average listener. At the present time no standards have been set in regard to some of the more recently studied forms of distortion, and previous standards for some of the others are being revised in the light of further knowledge. However, experience has indicated certain distortion levels which may be accepted as the requirements for good reproduction, and the degree of success with which a system meets these requirements may be considered as a measure of the quality of reproduction.

Complete reproduction of all the fundamentals and harmonics which are present in music produced by a symphony orchestra would require a frequency range of approximately 20-14,000 cycles. However, for almost all practical purposes a frequency range of 40-10,000 cycles with satisfactory

distortion characteristics is quite acceptable to about 90% of the listeners to all types of speech and music. While such a reduction of bandwidth will remove some of the highest frequencies present in the original sound, this difference is not noticed by large numbers of listeners, and is in general felt to be not objectionable.

Harmonic and intermodulation distortion have been found to be extremely important factors in most of the equipment in current use. At the present time these are perhaps the most important types, since when they are high they tend to mask other forms of distortion because their effects are more unpleasant. For many years it was believed that 5% total harmonic distortion was acceptable in a high-quality system. However, it is now felt that this figure is too high (especially in amplifiers using beam-power tubes or pentodes, since 5% total harmonic distortion from them appears to be much more objectionable than 5% from triodes). Present thinking in the field of sound reproduction tends to indicate that the total harmonic distortion should not exceed 2%.

Although intermodulation is produced by the same non-linearity which causes harmonic distortion, there is no simple relation between the two, since intermodulation depends upon the order as well as the amount of harmonics. There-

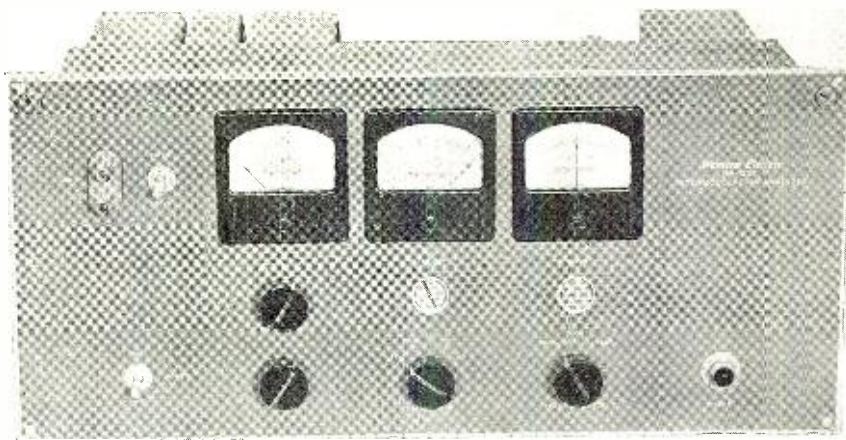

Front panel of RA-1257 intermodulation analyzer. When used with the signal generator shown on page 3, this equipment accurately measures intermodulation content.

Fig. 4. Block diagram showing composite signal generator, device under test, and the intermodulation analyzer.

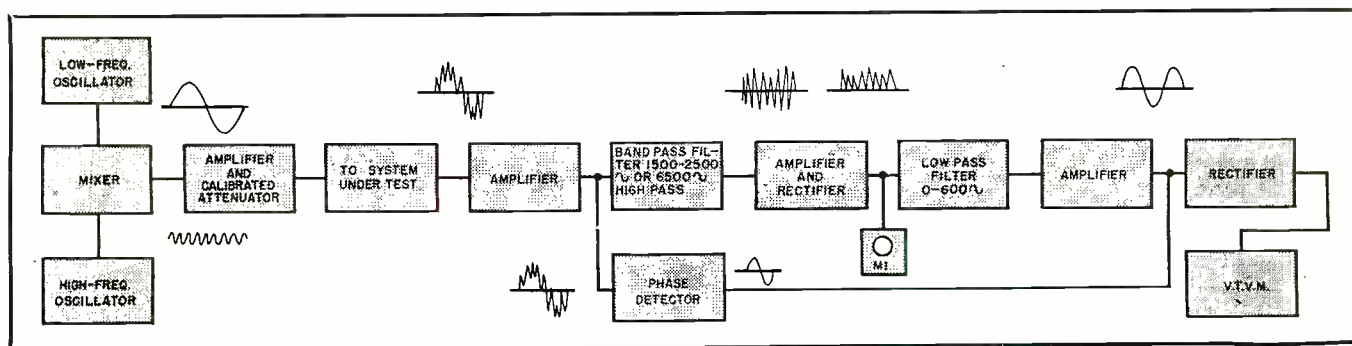

fore both should be specified as an indication of reproduction quality. In general, it is the intermodulation rather than the harmonics which is responsible for the disagreeable quality when a system is overloaded. This may be because harmonics are contained in various amounts in the sound of all musical instruments, whereas intermodulation products do not occur in natural sounds. From general experience it seems reasonable to rate an amplifier having 10% intermodulation with 2% harmonics as fair-quality, and one having 5% intermodulation with 2% harmonics as good.

The noise introduced by the reproducing system should naturally be kept as

low as possible, both because of its disagreeable quality and because of its limitation of dynamic range. The highest noise level is generally found in reproduction from phonograph records, due to the record scratch introduced by the surface of the disc. Considerable effort has gone into the development of circuits and other means to eliminate as much of this noise as possible, with varying degrees of success. Other parts of the system, however, should introduce practically no noise. Thus, for a system of good quality the noise and hum level (except for the phonograph disc) should be of the order of 50 to 60 decibels below full output.

If the noise and distortion of the system are within the limits required for good reproduction, then the various other forms of distortion are not masked and become important. Measurements of steady-state response are often not completely indicative of the quality of a system. It has been found that two systems with identical steady-state responses may sound quite different when tested with a dynamic signal such as speech or music. The difference between the two systems is generally found to be in the transient response. This effect is found especially in the electromechanical components of the system.

(Continued on page 29)

TABLE I—Summary of the types of input and output signals and measuring equipment which must be used in testing the various units of an audio reproducing system.

Type of audio reproduction unit	Input			Output			Comments, and precautions which must be taken in performing measurements.
	Type of signal	Source of signal	Terminal impedance	Type of signal	Type of measuring equipment	Terminal impedance	
Microphone	Sound	Calibrated loudspeaker	Air in room	Voltage or current	Vacuum-tube voltmeter	Resistance or transformer	Acoustics of measuring room must be planned to avoid acoustical resonances. Signal source and measuring meter must not introduce inaccuracies. Calibration of loudspeaker must be accurately known.
Amplifier or other electrical transmission circuit	Voltage or current	Electrical signal generator or amplifier	Resistance or transformer	Voltage or current	Vacuum-tube voltmeter	Resistance or transformer	Input and output impedance must be properly matched to correspond to actual operating conditions. If auxiliary amplifiers are used in measurement, they must not introduce inaccuracies.
Recording head Disc Film Magnetic	Voltage or current	Electrical signal generator or amplifier	Resistance or transformer	Mechanical, Optical, or Magnetic	Calibrated pickup	Record material	Mechanical drive should be free of flutter. Effects of record noise and flutter must be taken into account. Characteristics of calibrated pickup must be accurately known.
Record Disc Film Magnetic	Mechanical, Optical, or Magnetic	Recording head	_____	Mechanical, Optical, or Magnetic	Calibrated pickup	_____	
Pickup Disc Film Magnetic	Mechanical, Optical, or Magnetic	Calibrated record	_____	Voltage or current	Vacuum-tube voltmeter	Resistance or transformer	Mechanical drive should be free of flutter. Effects of record noise and flutter must be taken into account. Characteristics of calibrated record must be accurately known.
Loudspeaker	Voltage or current	Electrical signal generator or amplifier	Resistance or transformer	Sound	Calibrated microphone	Air in room	Acoustics of measuring room must be planned to avoid acoustical resonances. If auxiliary amplifier is used in measurement, it must not introduce inaccuracies. Characteristics of calibrated microphone must be accurately known.

SYNCHRONIZATION of two widely separated frequencies, required in many FM and TV transmitters, and desirable in many other applications such as PTM equipment, can be simply accomplished through the use of the high-ratio frequency divider described in this article. This divider, which is capable of giving stable frequency division as high as 300 to 1 (for example 4.5 megacycles to 15 kilocycles), requires but one tuned circuit and two tubes.

It is well known that in television transmitters a synchronization generator is required to properly time the blanking, horizontal sync, and vertical sync signals so that accurate interlacing of the scanning pattern is accomplished. To achieve this proper timing, the 60 cycle power source signal is employed as the basic reference frequency and all other signals synchronized with it. This means, for example, that a 31,500 cycle signal must be compared with a 60 cycle signal and the only way this can be accomplished is to either frequency divide the 31,500 signal to 60 cycles; frequency multiply the 60 cycle signal to 31,500; or simultaneously frequency multiply the former signal and divide the latter until a common frequency is obtained. Of course, all of these operations must be designed with care, otherwise the primary objective of the circuit would not be achieved.

In this case, since frequency multiplication of the 60 cycle signal would be very costly, the frequency division method is chosen. However, heretofore, in order to assume stable frequency division, frequency dividers of the order of 7 (maximum) had to be employed. Thus, for a total division of the order of several hundred, a number of divider circuits had to be cascaded, with the result that 10 tubes or more are frequently required to compare the two signals. With the high ratio, precision divider described in this article, the same result can often be accomplished with two tubes, or in extreme cases with four tubes.

Simple Multivibrator Divider

In order to fully understand the operation of the high ratio divider, a brief description of the conventional multivibrator divider, shown in Fig. 1, is helpful. This circuit operates in the following manner: When plate voltage is applied to the circuit, one tube tends to draw slightly more plate current than the other. As a result of feedback, this current will increase rapidly and the plate current of the other tube will decrease to cutoff. The drop in plate voltage across the conducting tube causes a negative step of voltage to appear at the grid of the cutoff tube

High-Ratio MULTIVIBRATOR FREQUENCY DIVIDER

By **MARTIN SILVER**

Senior Project Engineer
Federal Telecommunication Laboratories

Stable frequency divisions of as high as three hundred to one may be obtained in one multivibrator stage with this circuit.

through its coupling capacitor. Because of the amplification of the tubes, the grid voltage is driven well below cutoff. The coupling condenser tends to maintain this negative voltage, but its charge leaks off through the grid resistor in an exponential manner with a time constant equal to $C_c R_g$, increasing the grid voltage. As this voltage reaches the cutoff value, plate current begins to flow, decreasing the plate voltage. The negative voltage thus developed at the plate is then applied to the grid of the other tube, driving it to cutoff and repeating the above process. Fig. 2A shows the grid voltage on the first tube for this free-running multivibrator.

A free-running multivibrator of this type can be synchronized with another pulse source whose frequency is either

slightly higher or a multiple of the free-running frequency. This is done by applying positive synchronizing pulses to one of the grid circuits. These pulses should be of sufficient amplitude to raise the negative grid to the triggering potential at the desired multiple. Thus the cycle is initiated at the time of application of the synchronizing pulse. This is shown in Fig. 2B. In this form the multivibrator is a frequency dividing network.

It is apparent that as the order of frequency division is increased, the values of the amplitude of the synchronizing pulse plate voltage, and that of R_g and C_c , become increasingly critical. A slight change in any of these factors may cause a 20/1 divider, for example, to divide at 19/1 or 21/1. For this reason, this circuit cannot be used for high order frequency divisions where a high degree of stability is required.

Fig. 1. Typical multivibrator divider.

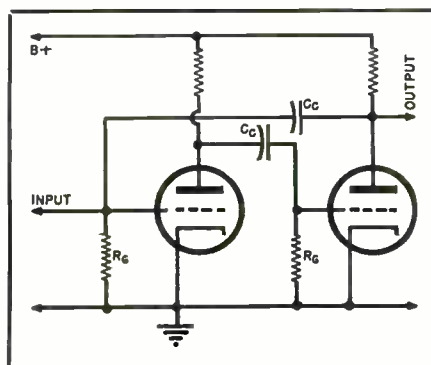

Introduction of Tuned Circuit

A frequency divider system that does not contain factors as critical as those of the multivibrator shown in Fig. 1 and therefore permits stable division of the order of several hundred can be achieved by replacing the feedback condenser, between the plate of V_2 and the grid of V_1 , with a tuned circuit whose output is clipped. To illustrate the effect of the tuned circuit on the multivibrator action, its effect on a simple two stage amplifier system, which can

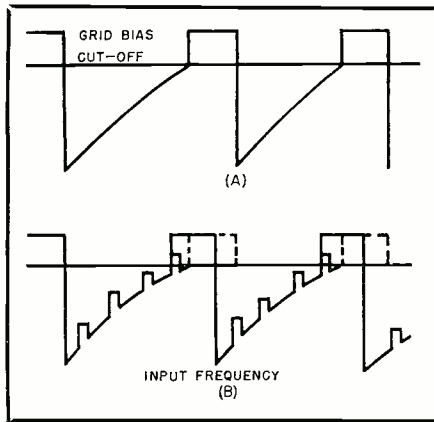

Fig. 2. (A) Grid voltage in free-running multivibrator circuit. (B) Grid voltage in a conventional frequency-dividing multivibrator.

be more readily visualized, will be considered first.

A signal impressed across the grid of V_1 of the two stage amplifier circuit, shown in Fig. 3, appears in the plate of V_1 shifted in phase by 180° . Assuming that the RC constant is sufficiently high so that no appreciable phase shift occurs through the coupling condenser, this signal will then appear in the plate circuit of V_2 , delayed by 360° but in phase with the applied voltage. If the plate of V_2 is then coupled to the grid of V_1 , the circuit will oscillate.

The presence of a tuned circuit in the feedback system between the plate of V_2 , in Fig. 3, and the grid of V_1 means that oscillation will occur only when the input signal is of the same frequency or a harmonic of the tuned circuit as illustrated in Fig. 4A. The frequency of such a circuit, however, is a function only of the tuned circuit and not of the applied signal. The object of a frequency divider is, of course,

Fig. 4. (A) Transmission characteristics of tuned circuit. It should be noted that, for practical considerations, feedback will only occur at f_0 . (B) Transmission characteristic of tuned circuit and clipper coupling circuit. It should be noted that in this case feedback occurs from $f = f_1$ to $f = f_2$.

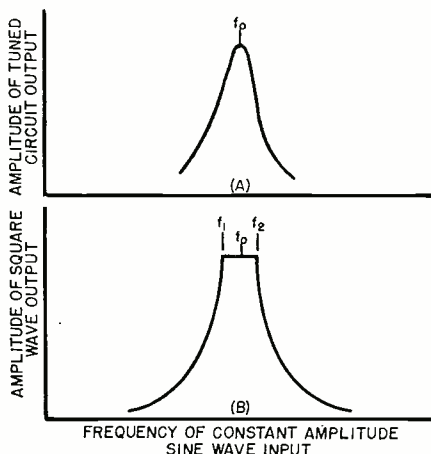

to obtain an output that is subharmonic of the input frequency. Hence this circuit, as it is, could not serve this purpose.

However, by clipping the sine wave output of the tuned circuit, the range of oscillation can be extended. For with this output, oscillation is permitted to occur as long as the peak of the appropriate subharmonic of the input appears within the flat, or clipped, portion of the sine wave as illustrated in Fig. 4B. As seen in these figures, the frequency of oscillation of this circuit is directly dependent upon the frequency of the applied voltage, assuming that its subharmonic falls within the flat portion of the clipped sine wave. It is also readily seen that if the wavefront is steep, a high degree of frequency division stability is achieved, with very little likelihood of variation due to input signal or plate voltage changes.

High-Ratio Multivibrator Frequency Divider

Fig. 7 is the schematic diagram of

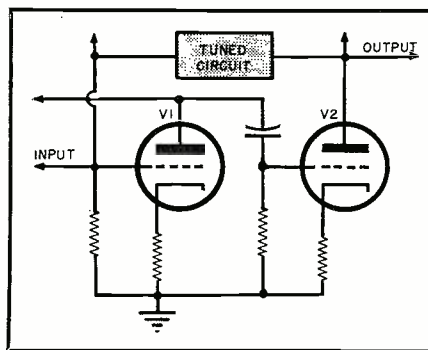

Fig 3. Two stage amplifier with tuned circuit feedback.

the multivibrator of Fig. 1 in which the feedback condenser is replaced with a tuned circuit followed by a two-stage clipper. The output of the second clipper is fed back to the first grid. Resistor R has value in order that the Q of the tuned circuit may be high, and the bias on the first clipper is made high enough to prevent the flow of grid current. The condensers employed in the clippers all have comparatively high values of capacitance.

As in the circuit shown in Fig. 3, it is seen that this circuit will oscillate only in the immediate vicinity of the resonant frequency of the tuned circuit, with or without synchronizing voltage at the input. A sine wave will be obtained at output A, while one side of the sine wave will be clipped at the grid of the second clipper stage. At output B, and in the multivibrator circuit proper, a square wave will be obtained. If a synchronizing voltage of a frequency close to an integral multiple of the tuned circuit is applied across the input, the multivibrator will

adjust itself to an exact subharmonic of the input.

The operation of this circuit is similar to that occurring in the two-stage amplifier with the clipped sine wave feedback. The action here is that of a lock-in of an unstable oscillator to a stable oscillator; a necessary condition for lock-in is that the two oscillators have a harmonic frequency in common; this is the purpose of the double-clipper stage, which generates harmonics by squaring the sine wave. The frequency of the synchronizing voltage (the stable oscillator) must be close to one of the multivibrator harmonics for lock-in to occur; the higher the order of division desired, the more important it is that the wave be square. Since it is difficult to obtain good square waves at high repetition rates of several hundred kc., it is correspondingly more difficult to obtain good division at the higher frequency. The actual lock-in forces are produced by third-order non-linearities in the tube operating characteristic.

Lock-In Range

For any given order of division, there is a range of synchronizing frequencies at which proper division is obtained. This synchronizing frequency range is directly proportional to the multivibrator operating range, the latter being determined by the Q of the tuned circuit. If the multivibrator is driven at a different frequency from the exact resonant frequency of the tuned circuit, a phase shift is introduced in the tuned circuit; the phase shift for a given deviation in frequency increases with increasing Q , and proper division no longer occurs when the phase shift exceeds a certain critical value. This process can readily be observed by placing the output of the clipper across an oscilloscope and varying the input frequency about the resonant frequency of the tuned circuit. In this way the exact range of the multivibrator can be determined for any given value of Q , which of course is essentially equal and can be varied readily by varying R .

For example, assume that an application arises in which it is desirable to frequency divide a 600 kc. signal to 15 kc. (40 to 1). Assume also that the limits of frequency variation of the stable oscillator are from 599.400 kc. to 600.600. This means that the frequency range of the multivibrator must be from $599.400/40$ or 14.985 to $600.600/40$ or 15.015. Within this multivibrator range, the synchronizing range of 39/1 frequency division would be 584.415 to 585.585 kc., while that of a 41 to 1 division is 614.385 kc. It should be noted from these figures, which are graphically presented in Fig. 5, that the center frequency must deviate approximately 15 kc. before an error in

frequency division would occur. For higher orders of frequency division, where adjacent synchronizing ranges come closer to each other, it is necessary to restrict the multivibrator operating range to smaller regions by using higher Q 's.

The transmission characteristic of the circuit is shown in Fig. 4B. This curve may be obtained by removing the capacitor between the input grid and the second clipper plate, applying a variable-frequency constant-amplitude wave to the input, and examining the output at the second clipper. The output voltage will reach the maximum value at a very low input voltage (of the order of millivolts) and will then be in the form of a square wave. The plateau width can be varied by changing the bias of the first clipper. Actual tests indicate that this plateau width bears no relation to the multivibrator lock-in frequency, and it is only the extent to which this plateau is absolutely flat that is of importance where high ratios are required. However, the width of the plateau should not be so large as to cause the multivibrator to lock-in with another mode, i.e. if 40 to 1 division is desired, multivibrator range should not be so wide that 39 to 1 or 41 to 1 division is possible. For example, consider the synchronizing frequency range of 600.6 to 599.4 kc. shown in Fig. 5. If the multivibrator range were 15.4 to 14.6 kc., then a 599.4 kc. signal could be divided by either 39 (giving 15.37 kc.) or by 40 and still fall within the proper multivibrator range.

Final Circuit

Fig. 6 is the detailed schematic of a circuit that gives stable frequency division ratios as high as 300 to 1, in this case 4.5 megacycles to 15 kilocycles. The output frequency can be adjusted by the variable condenser in the tank circuit. Adjustment for the proper division can be made most easily with an oscilloscope at any of the plates. When the multivibrator locks-in with the synchronizing frequency, it is possible to count the number of synchronizing-frequency pulses per multivibrator cycle. Of course, where frequency division of the order of hundreds is involved this latter procedure is not convenient. In this case the output of a standard frequency generator should be applied to the divider input, and the frequency division ratio determined by noting the input and output frequency within the lock-in range.

The circuit described has the outstanding advantage of simplicity. It requires but one tuned circuit and two tubes, and is quite insensitive to changes in operating conditions. In fact, since the values of resistance and

capacitance have so little effect on the frequency, it would seem incorrect to call the circuit a multivibrator, except that it is derived from the conventional multivibrator circuit, and it does produce easily synchronized square waves.

Application of the High-Ratio Frequency Divider

The high-ratio divider should find wide application in many phases of electronic equipment design. One outstanding application is its use to provide a precise, low cost, low-frequency generator. It is well known that crystals provide an excellent method of achieving high frequency stability with relatively simple circuits. Hence, it is desirable to utilize crystals wherever possible. However, a crystal whose fundamental frequency is 8 kc., for example, is both bulky and expensive.

A logical alternative would therefore be to utilize a 96 kc. crystal, which is relatively small and economical, and by frequency division develop a stable 8 kc. signal. Heretofore this was not practical since it involved at least two multivibrator and two isolating stages and included highly critical factors. However, through the use of the high-ratio frequency divider circuit described in this article, this can now be done simply and economically.

This 8 kc. generator is now being applied in pulse time modulated microwave radio links where the repetition rate of the pulse is 8,000 times per second. In this application it is extremely important to maintain the 8 kc. signal generator frequency constant because modulation of the pulses is a function of the position, and a variation in the signal generator frequency, which is used to establish the basic timing, would appear in the receiver in the form of distortion.

FM Transmitters

This circuit can be used in FM transmitter design to save as many as 10

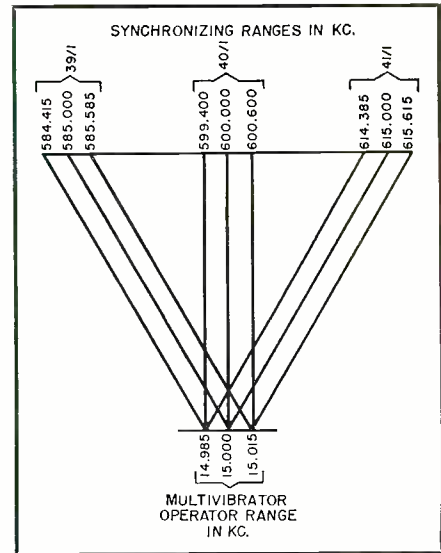

Fig. 5. Illustrations of synchronizing ranges of multivibrator-divider circuit of Fig. 1.

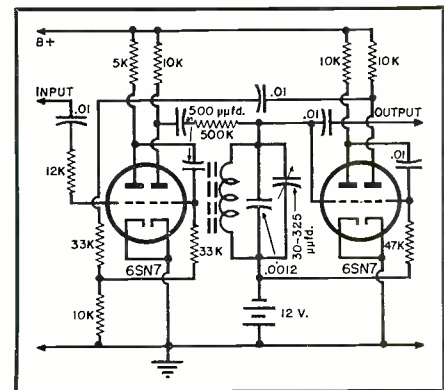
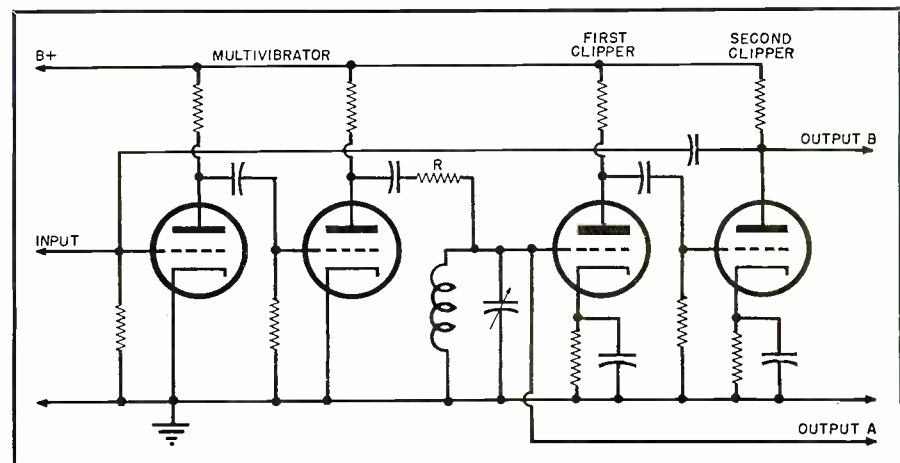

Fig. 6. Circuit dividing from 4.5 mc. to 15 kc., a 300-to-1 range. Inductance L consists of 800 turns of No. 28 AWG wire on a powdered-iron toroid.

tubes in the center frequency stabilization system. To comply with the requirements of the Federal Communications Commission, the mean frequency of an FM transmitter must be main-
(Continued on page 19)

Fig. 7. Modified circuit of Fig. 1 in which capacitor is replaced by tuned circuit and two clipper stages.



SUBMINIATURE DECADE COUNTER

Counter features 11 subminiature thyratrons, circuit components and plug-in structure only slightly larger than a 6L6 tube.

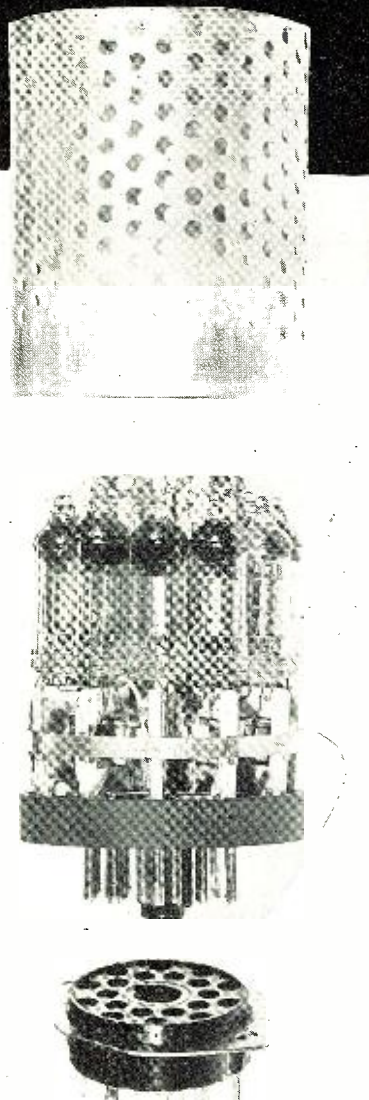

Fig. 1. Disassembled view of the decade counter.

BY W. W. SNYDER

Sylvania Electric Products Inc.

RECENT developments in the electronic computer field have stressed the reduction in number of electron tubes, improved methods of channeling instructions and the importance of making more compact machines for wide application. Because of the relatively large number of tubes and circuit components required for computers in their simplest form, extensive development has taken place in the miniaturization of electronic counters.

A recent development of a subminiature decade ring counter developed for the U. S. Army, which is hardly larger than a 6L6 tube, and which replaces a unit approximately ten times as large, is shown in Fig. 1. The subminiature unit is only 2" in diameter, 2½" high and weighs only 4½ ounces.

This unusual compactness has been accomplished through the use of a com-

bination of printed circuits, subminiature tubes and resistors, wafer capacitors, ceramic card sub-assemblies and plug-in-terminal mounting. It contains eleven subminiature thyratrons, eighty resistors and twenty-three capacitors.

The decade counter, which operates on a base ten system, is more complex than binary types which use two as a base and are of relatively simple design being essentially "on" and "off" systems.

A mechanical counterpart of the decade counter is found in the commercial adding machine with rows of keys corresponding to our number system of multiples of ten. When the unit key is actuated ten times the register in the tens column advances to one. Likewise ten actuations of the tens key advances the hundreds register to one.

The same statistical process occurs in the electronic decade counter but actuation is electrical rather than mechanical. Instead of the force of the finger on the key, the electronic counter is actuated by a voltage pulse applied between two input terminals. Ten input pulses are required before a single pulse is transmitted to the next decade circuit.

Typical counting tubes in the subminiature decade counter are T-3 thyratrons shown in Fig. 4. They serve as electrical one-way switches actuated by an increase in grid voltage which makes

the tube conductive. The grid closes the circuit, but once it is closed it cannot be opened by grid effect. In order to return the tube to a non-conducting state, its anode or plate voltage must be lowered for a short time to permit deionization and subsequent return of grid control.

The resistor network, R_1 , R_2 , R_3 is a voltage divider supplying -4 cathode volts for tubes B and C and -38 grid volts for tube C. When tube A is conducting, current flows through the tube and resistor R_3 so that A cathode becomes positive at about 37 volts, voltage divider R_1 , R_2 in tube A circuit will bias tube B grid at -13 volts. In this condition tube C grid voltage, with respect to its cathode, is -34 volts but the corresponding value for tube B is only -9 volts.

Since the pulse input line is connected to all grids each tube will receive the same pulse but tube B will be fired by a pulse of about 15 volts positive, a much lower pulse than would be required by tube C. This leaves a good margin of safety, as the biasing of tube C is -34 volts and with the +15-volt pulse net bias is -19 volts on that tube.

After tube A has been conducting for a few microseconds, capacitor C_2 is charged to the cathode potential of +37 volts. When tube B fires, an addi-

(Continued on page 31)

Fig. 2. Circuit of a portion of the counter, showing principles of operation.

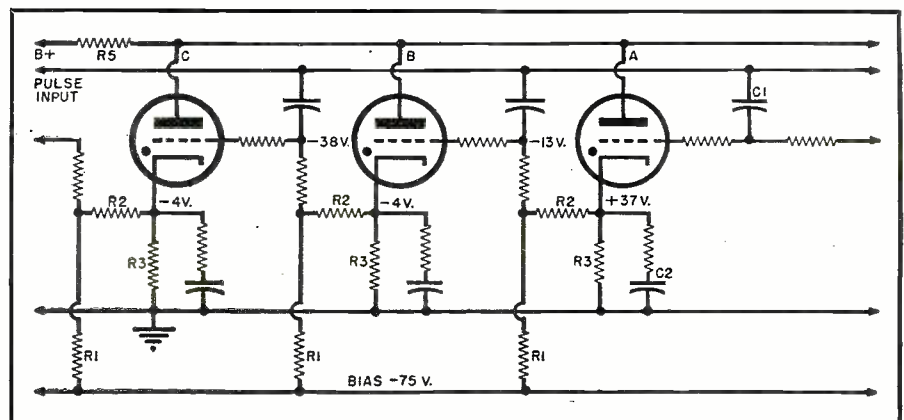

CAPACITANCE METHOD of Measuring Wear

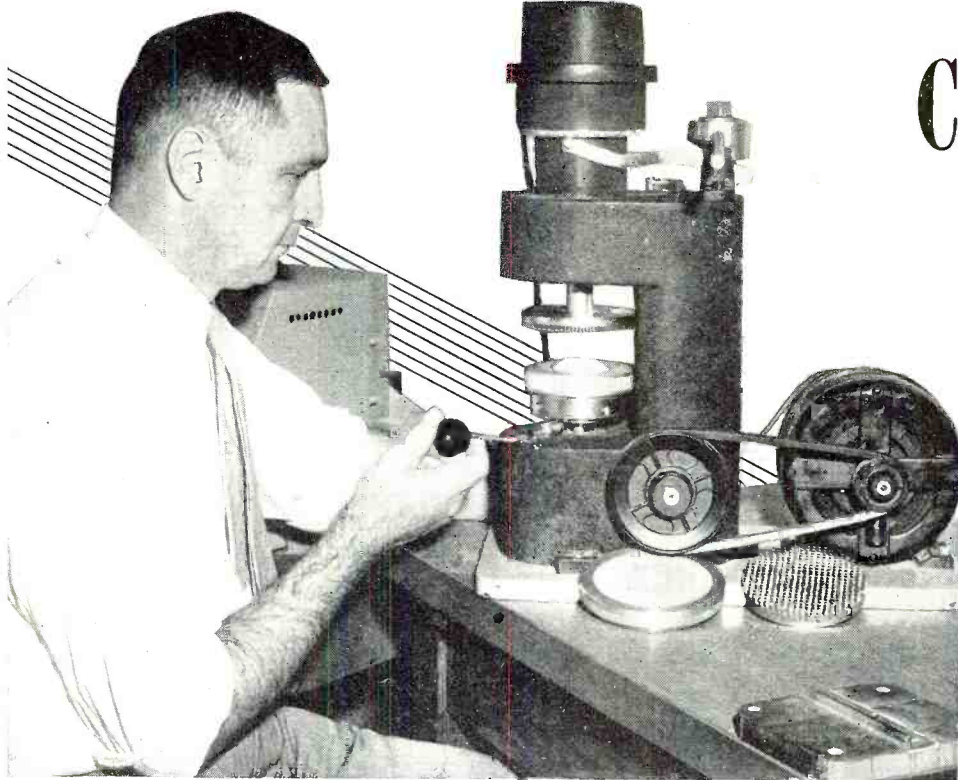

An improved Schiefer abrasion testing machine designed and used at NBS.

By using the textile material under test as the dielectric of a calibrated condenser, the amount of wear may be measured by the change in capacity.

A CONVENIENT, nondestructive method for measurement of the abrasive wear of textiles' has been developed by Dr. Herbert F. Schiefer, Lawrence E. Crean, and John F. Krasny of the National Bureau of Standards as part of a program sponsored by the Office of the Quartermaster General, Department of the Army. Depending only on the change in capacitance of the specimen with wear, the method is simple, rapid, and highly sensitive. As capacitance is measured without disturbing the specimen, readings may be taken at frequent intervals during a test and the rate of wear thus evaluated.

Although resistance to abrasion is an important factor in the serviceability of textiles, the laboratory study of this property has been hampered by lack of a satisfactory objective method. In addition to visual estimates of wear and measurements of the time required to abrade completely through a sample, a number of specialized procedures have been devised, based on changes in thickness, air permeability, light transmission, and breaking strength of the abraded material. However, none of these techniques has proved entirely adequate. Measurement of reduction in breaking strength has been widely used but has the obvious disadvantage that the specimen must be destroyed in or-

der to determine its breaking strength. Thus it is not possible by this method to plot a consistent wear curve with data obtained from a single specimen. Variations in thickness, while of some significance with heavy-pile materials, are not necessarily indicative of wear in ordinary fabrics. Changes in air permeability and light transmission are difficult to interpret in terms of wear since these properties may be altered by flattening of the nap with use. The method developed at the National Bureau of Standards, on the other hand, measures a property of the sample—namely, its capacitance—which is very closely related to the amount of material remaining in the portion of fabric tested. Since the specimen is not destroyed nor altered in any way during the capacitance measurement, a complete set of data may be obtained, showing the rate of abrasion at all times during the life of a single specimen.

The new method requires only three capacitance measurements to determine the extent of wear in a specimen over any interval of time. The electrodes of a precision capacitor are first adjusted to be slightly farther apart than the thickness of the thickest specimen to be studied. The capacitance C_a of the intervening air space is then measured. The capacitance C_o with the unworn specimen between the electrodes is next

obtained, and finally the capacitance C_R of the abraded specimen. The measure of destruction or ruin, Q , is then given in percentage by the formula:

$$Q = \frac{C_o - C_R}{C_o - C_a} \times 100\%.$$

As the dielectric properties of textiles vary markedly with the percentage of adsorbed moisture, the moisture content of the specimen should be kept constant throughout any given series of capacitance measurements by working in a conditioned room.

In the laboratory testing of textiles, C_R is taken as the capacitance of a specimen after it has undergone R rotations against the abradant in an abrasion machine. If a number of values of Q are obtained for various values of R , then a wear curve may be plotted which is found to be characteristic of the fabric tested. In general, woven fabrics become unserviceable when Q approaches a value of 50 per-cent.

(Continued on page 20)

Abrasive wear in textiles is determined by measuring change in capacitance of specimen.



SOUND MIXER for TV Film Recording

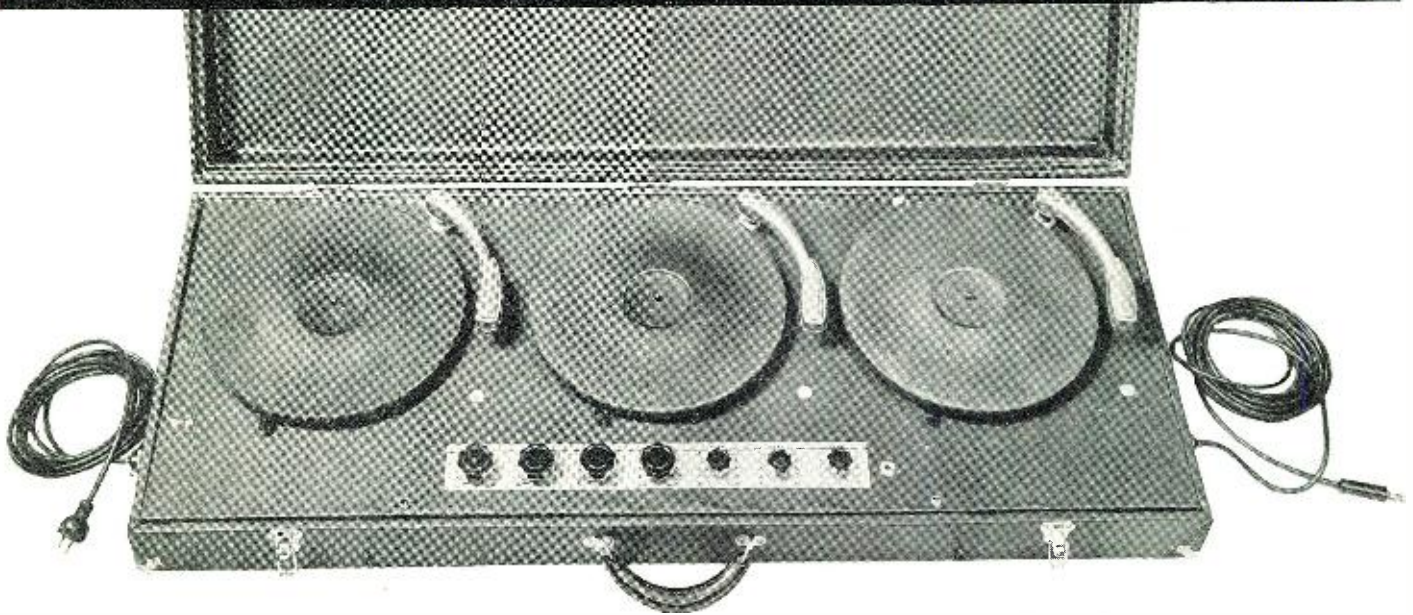

By JOHN B. LEDBETTER

Station WKRC-TV, Cincinnati

The design and construction of a flexible mixer unit for use in dubbing sound on special-feature television or movie film.

▶ THANKS to the present demand for good television film, hundreds of small, independent film and sound studios have been given the opportunity to expand in a way never before possible. Most of these are, or soon will be, in a position to provide custom-made film of sports, news and other special-events features of both local and nation-wide interest. Although many such films, including musicals, dramatic shows, etc., already are being produced by at least two networks and by a number of recently-formed television-film companies, the demand is far from being satisfied. Regardless of how many network and other specially-produced films are released in the future, there will always be an insatiable demand for timely, on-the-spot film recordings which contain "local flavor". These usually must be supplied either by a local film producer or by a field unit operating from a larger film agency. In most cases, an established, adequately-equipped local company will be in a better position to select, film and edit local features; the wide-awake film operator who proves this point will have taken the most important step toward

building a thriving, lucrative business.

In film recording, there are two general methods which may be used in transcribing the sound. It may be recorded at the time of filming and accordingly edited along with the film, or it may be "dubbed" onto the sound track after the film has been edited and cut to its required length. Both methods, of course, have their advantages, the use of either depending on particular or individual circumstances. The first method, for instance, is used in musical productions, dramatic productions, inaugurations, speeches and other features where the true, original sounds must be reproduced. This requires, of course, extra time in setting up and checking microphones and associated audio equipment, plus in most cases a sound engineer to operate the mixing and gain controls. This, of course, is normal procedure in the studio. In the field, however, special or emergency situations often arise which preclude the use of anything above the bare minimum of equipment. Such cases might be cited in explosion, flash floods, plane crashes, etc. where the cameraman must work at top speed if he is to film any

Fig. 1. The special sound mixer uses three turntables for maximum flexibility. Each is dual-speed for either standard 78 r.p.m. or 33½ r.p.m. discs and each has a separate mixer and tone control. A master volume control is included.

action at all. In other cases where remote or field work is required, the batteries or emergency power supply might not be capable of operating the full equipment for the required amount of time. In these instances, it is often advantageous to make the film *without* sound. Then, at the studio, it can be edited and cut if necessary to meet program requirements. Recorded background music, fanfares, sound effects, narration (live or recorded) etc. can then be "dubbed" onto the sound track in the usual manner. In this way, several completely different film features can be combined into one continuous, smooth-running program.

It is at once apparent that some sort of sound mixer or console incorporating two or more turntables must be used for cueing, mixing and fading the recorded portions of the sound material. For simple recording one single-speed turntable, of course, may be sufficient. Such a unit, however, lacks flexibility and is actually a handicap in the more complicated setups.

The mixing unit shown in Fig. 1 was constructed by the author for use in recording sound on television and movie film. Designed for maximum flexibility and ease of operation, it was built for G. Henry Thurmond, independent television film producer of Cincinnati, Ohio.

Like most independent producers, Thurmond personally supervises production of all special events and television recordings, and in many cases operates the sound mixing unit.

In designing this particular mixer, the following requirements were decided on as being absolutely necessary: (1) the unit must be portable (light enough to be carried by one man); (2) at least a three-table setup must be provided; (3) mixer controls should be arranged to allow either individual control of the turntables or simultaneous control from a master gain control, and (4) each table should be equipped with a separate tone control so that any combination of sounds could be produced, either for "special" effects, or for matching the frequency response characteristics of recorded sound effects or transcribed commentaries. In addition, the controls should be arranged for greatest simplicity and ease of operation. All turntables, of course, must be dual-speed to handle standard 78 r.p.m. phonograph records and commercial $33\frac{1}{3}$ r.p.m. discs. An important factor in deciding the layout and type of components was governed by the over-all cost, which was kept as low as feasible without affecting quality, efficiency and ease of operation.

Requirement (1) was satisfied by mounting the turntables and pickups as close as possible (spacing between adjacent pickup heads and turntable rims was approximately one inch). Since no 16-inch transcription discs were to be used, the physical size of the unit could be kept to an absolute minimum.

The *General Industries* dual-speed, dual-motor tables were selected for several reasons. First, their $12\frac{3}{4}$ -inch rims are fairly heavy, providing good regulation and freedom from "wows". Second, the rubber idler wheels for both speeds are thrown to a "free" position. This prevents the occurrence of flat spots, normally a common fault with the lower-price tables employing this type of drive. Last, the cost of the tables was well within the budget worked out for the unit.

A three-table arrangement was selected as being sufficiently flexible for the majority of applications. (A typical setup might include one table for recorded background noise, music or sound effects, one for fanfare or musical bridges and a third for recorded commentary). A jack on the front panel of the mixer allows use of a fourth turntable (for playing 16-inch transcriptions, for example) when desired. This jack is wired directly into the master gain control.

The mixer circuit is extremely simple and straightforward. The three gain controls and the master are each 2

megohms, paralleled to give 500,000 ohms output impedance. Interaction between controls is negligible even at maximum settings. It is believed the tone control circuits are novel in this particular application, inasmuch as the 500,000 ohm, .01 μ fd. series combination is connected directly across each pickup head. This gives the desired amount of tone change, however, without seriously affecting the output level. As in the case of the gain controls, no interaction between individual controls is present. This feature of course is desirable in any sound-mixing setup, in that any of the gain or tone controls can be cut completely in or out without requiring compensation of other control settings.

With the mixing arrangement described above, all gain controls can be operated individually, or they can be pre-set and controlled simultaneously through the master gain control.

The entire mixing unit is mounted on a $\frac{1}{2}$ -inch plywood board measuring 19" x 42". Although the motor plates in each table are shock-mounted, each table was mounted on four live rubber grommets in order to reduce the possibility of hum pickup or mechanical "rumble" transfer to the pickup heads.

Since standard-length control shafts were used, it was necessary to countersink (from the bottom) through three layers of the plywood in order to mount the controls and pickup arms. This was easily done by using a $1\frac{3}{4}$ " circle cutter and a drill press. In wiring, all a.c. leads were run straight across the back of the board, as far as possible from the audio leads, to keep hum pickup to an absolute minimum. All leads, including those to the tone controls, were completely shielded and bonded to a common ground point. The a.c. and audio output circuits were terminated in midget *Hubbell* female and male sockets, respectively. The 15-foot audio extension cord is in turn shielded all the way to the plug.

It will be noted that three small holes (temporarily plugged) appear to the right and just in front of each turntable. These were cut out for small pilot lamps, to illuminate the control panel when the mixer is used in subdued lighting.

Over-all dimensions of the case measure $6\frac{1}{2}$ " x 20" x 43". The top and bottom sections of the case, which are $3\frac{1}{2}$ " and 3" inches deep, respectively, are covered with $\frac{1}{2}$ " plywood. The sides are constructed of 1-inch pine board in order to reduce cost. The entire case is covered with black leatherette and equipped with chrome corner protectors to give professional appearance as well as added protection. The insides of the case are reinforced with corner blocks and braces at all points of stress, espe-

cially at the handles. Sides are held together with wood glue and $1\frac{1}{2}$ " screws. The over-all cost of the mixer was quite reasonable and performance has been satisfactory in all respects, matching that obtained from much more expensive commercial equipment.

In Fig. 1, the three mixer controls and master volume control can be seen at the left front, while the three tone controls are at the right front. Sufficient cord is provided with jack J, so that an additional turntable and pickup, such as a 16 inch transcription unit, may be connected in with this mixer and operated at a considerable distance from the mixer. A suitable nameplate indicates the functions of the various controls.

Carbon-type controls often develop noisy spots if left at their normal operating settings. For this reason, the gain and tone controls should be returned to their minimum settings when not in use. Occasional rapid rotation of controls will serve to clean the wiper surfaces and aid in preventing noisy operation.

The various details treated in this discussion may seem rather lengthy and needlessly drawn out. They have been so treated, however, in the hope of covering all the problems, or at least all the basic ones, which the film producer or recording engineer will encounter in designing his own sound mixer. The circuit and layout, of course, can be extended and improved to meet individual requirements. Applications of such a unit are numerous, and a reasonable amount of care in the design and selection of components will be more than worthwhile.

Fig. 2. Complete circuit diagram of the sound mixer, excluding the a.c. circuit for the turntable motors. Note that jack J1 is connected ahead of the master volume control. The tone control circuits are connected directly across the crystal pickups, which is rather unusual but has proved to be very satisfactory.

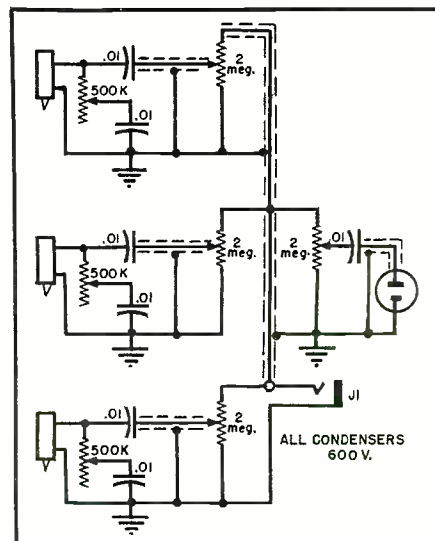

Electromechanical PHASE INDICATOR

BY SIDNEY WALD

Engineering Products Dept.
RCA Victor Div.

METHODS of measuring the phase displacement between two alternating potentials of the same frequency have always been important in electronic circuit development. Where the frequency is low and the available power is ample, the electro-dynamometer type of instrument has given satisfactory service. The measurement of power factor and the use of the conventional power station synchroscope in paralleling alternators are outstanding examples of phase measuring instruments.

When, however, we are confronted with high impedance, low potential sources which are not capable of supplying measurable amounts of power, it is obvious that new techniques are required. This paper describes a novel form of phase comparator which is useful up to about 400 cycles per second and whose input impedance is of the order of several megohms.

Fig. 1. Waveforms in the circuit of Fig. 3A. These curves show how the meter reading varies when phase 2 is fixed and phase 1 (the gate—see Fig. 2) is varied.

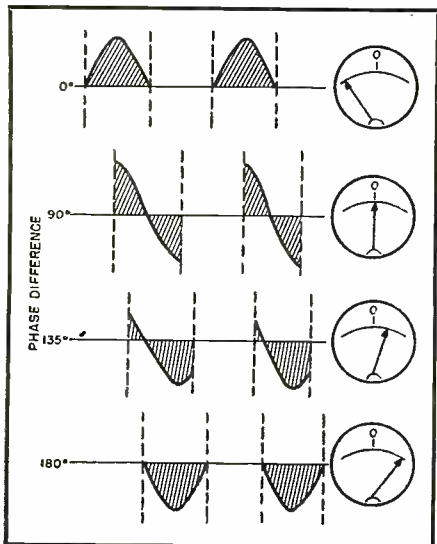

A novel form of phase comparator useful up to 400 cycles and usable with high impedance, low potential energy sources.

In its broadest aspect, the circuit is composed of a high-speed relay, such as the *Stevens-Arnold* type 172, the coil being driven by one of the input phases and the contacts forming a synchronous mechanical rectifier for the other phase. A zero center d.c. microammeter forms the rectifier load and may be calibrated directly in phase shift, zero to 180 degrees, or -90 degrees, zero, $+90$ degrees.

Referring to the circuit shown in Fig. 3A, the armature of the relay being driven from phase 1 opens and closes the meter circuit with the frequency and phase of the signal voltage on the left triode. Thus we have in effect formed a "gate" whose position is determined by one of the input voltages and whose width is fixed at approximately 180 degrees. The exact width of the gate depends on the pull-in and drop-out voltage of the relay. Fig. 2, showing the development of the switching gate, indicates that the current required to close the relay should be roughly equal to the steady state plate current of the tube with no signal on the grid.

Let us now examine the circuit to which phase 2 is applied. Here we find a small audio transformer with its primary connected to the right triode as a cathode follower and its secondary connected to a d.c. current measuring instrument in series with the gate already discussed. The indication on this meter is the average value of the a.c. waveform of phase 2 bounded by the closed gate due to phase 1. Fig. 1 shows how the meter reading varies when phase 2 is fixed and phase 1 (the gate) shifts over a range of 180 degrees.

When the two input voltages are in

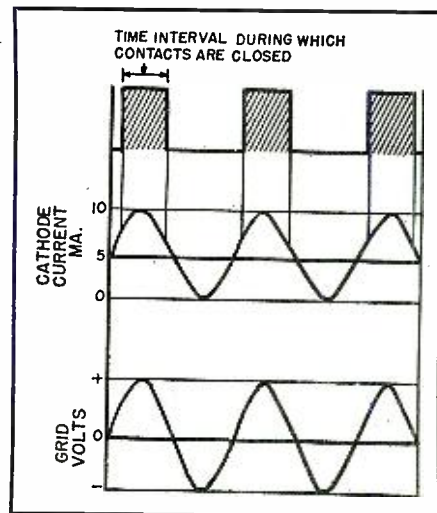

Fig. 2. Curves showing the switching gate development. The current required to close the relay should be roughly equal to the steady state plate current of the tube with no signal on the grid. The position of the gate is determined by one of the input voltages, and the width is fixed at approximately 180 degrees.

phase, the meter gives maximum deflection, say to the left. As the gate shifts to the right, the average current reading decreases, dropping to zero or center position at 90 degrees. Then as the phase continues shifting, the meter indication increases toward the right, reaching a maximum again at 180 degrees.

While a display similar to Fig. 1 is quite informative, it fails to show, of course, exactly how the meter reading varies with the phase difference between the input voltages. Fortunately, a simple analysis serves to clarify the relationship. Fig. 4 represents the

portion of the phase 2 included in the gate due to phase 1. Let the width of the gate be 180 degrees or π .

Then the meter reading will be proportional to the total area (in a positive and negative sense) included under the sine wave and bounded by the vertical lines representing the switching gate. If I_{max} represents the peak value of the sinusoidal current in the meter circuit, then the meter current is:

$$I_{ave} = \frac{I_{max}}{2\pi} \int_{\theta_1}^{\theta_2} \sin x \, dx$$

$$= \frac{I_{max}}{2\pi} [\cos \theta_1 - \cos \theta_2] \dots (1)$$

Since $\theta_2 - \theta_1$ always equals π , $\theta_2 = \pi + \theta_1$ and the integrated gate area becomes:

$$I_{ave} = \frac{I_{max}}{2\pi} [\cos \theta_1 - \cos (\pi + \theta_1)]$$

$$= \frac{I_{max}}{\pi} \cos \theta_1 \dots (2)$$

If we plot meter current I_{ave} versus θ_1 from zero to 180 degrees, we get the result shown in Fig. 5. This curve gives an indication of the non-linearity which would be present in a conventional current meter, and also indicates how such a meter might be calibrated without performing such a calibration experimentally.

Thus far we have discussed the applicability of the electromechanical phase comparator as a calibrated measuring instrument. In many instances what is desired is not so much a phase measurement but rather a stable and sensitive null indication when the phase difference is some pre-determined value. For example, let us assume we are designing an electronic servomechanism which functions as an automatic corrective device to maintain phase coincidence between two 400 cycle signals. (See Fig. 6A.) The circuit we have described becomes ideally suited for use as a phase error detector provided we insert a fixed phase shift of 90 degrees in one of the signal input voltages. Thus the desired condition of zero phase difference is presented to the circuit as a 90 degree condition which, of course, results in a null d.c. output. Phase deviation of either of the input signals causes mechanical rotation of the servo motor to correct the error. Such a system obviously requires great zero center stability to be of maximum utility.

In another typical circuit application, it was desired to observe the phase difference between two 30 c.p.s. voltages with exceptional accuracy (plus or minus 1 degree). The grid voltages were approximately 5 volts r.m.s. and a 500 ohm 500-0-500 microammeter was used as an indicator. Some idea of the

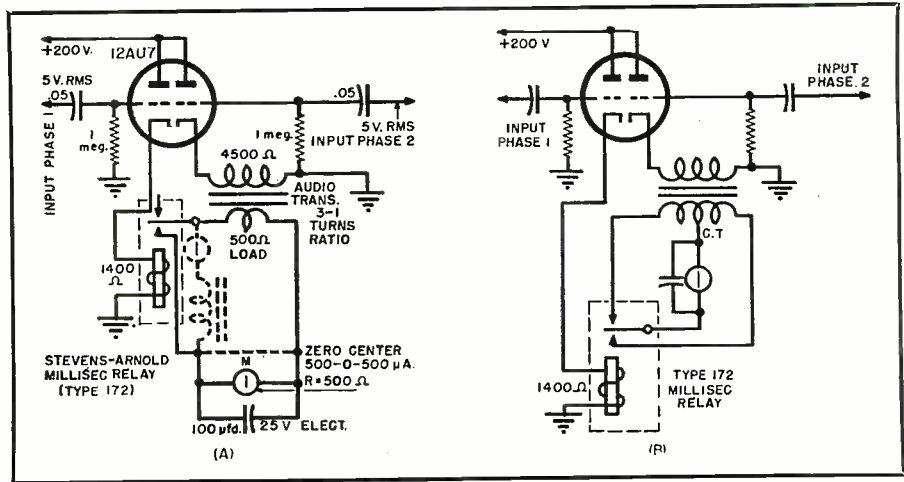

Fig. 3. (A) Circuit of the phase comparator, using a high-speed relay such as the Stevens-Arnold type 172. The solid lines show a series meter connection, and the dotted lines a parallel meter connection. (B) Phase comparator with a full wave meter connection. This provides greater sensitivity.

sensitivity obtained may be deduced from the fact that a 10 degree phase difference was sufficient to give maximum meter deflection.

Instead of using a calibrated meter, it will usually be more desirable to use a sensitive zero center null indicator and read the phase difference on a calibrated goniometer or resolver which is placed in the circuit of one of the input voltages. See Fig. 6B.

The high speed relay is obviously the most important unit of the system from the standpoint of accuracy and stability. Reference has already been made to the Stevens-Arnold type 172. This device has single pole double throw contacts, a coil resistance of 1400 ohms, and is useful up to approximately 500-600 c.p.s. If more sensitivity is desired, the meter circuit may be arranged full-wave as shown in Fig. 3B. This circuit is advantageous in that the size of the meter bypass capacitor may be reduced and the d.c. output per degree phase shift will increase by a factor of two.

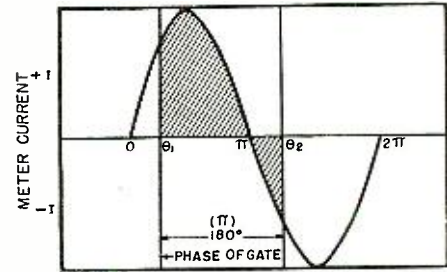

Fig. 4. Plot showing how meter current varies with phase of gate.

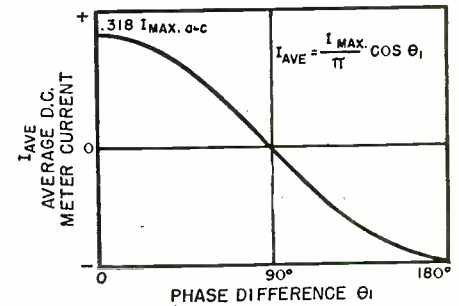
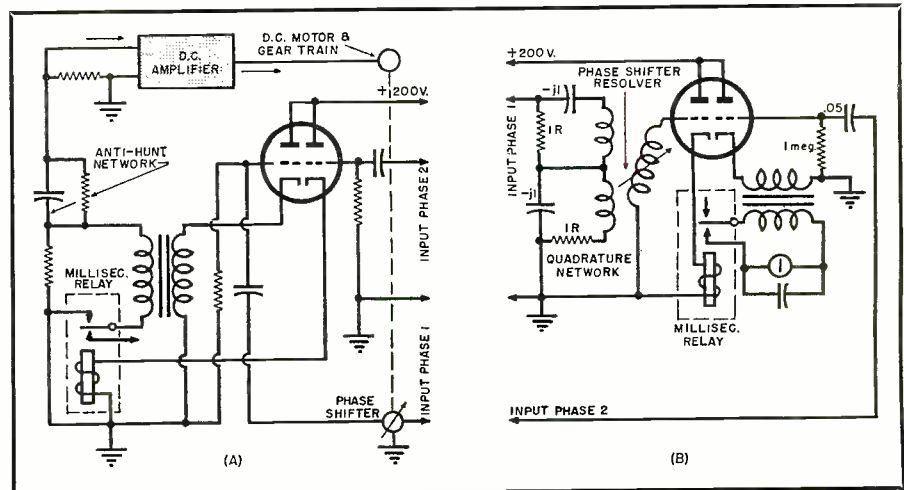
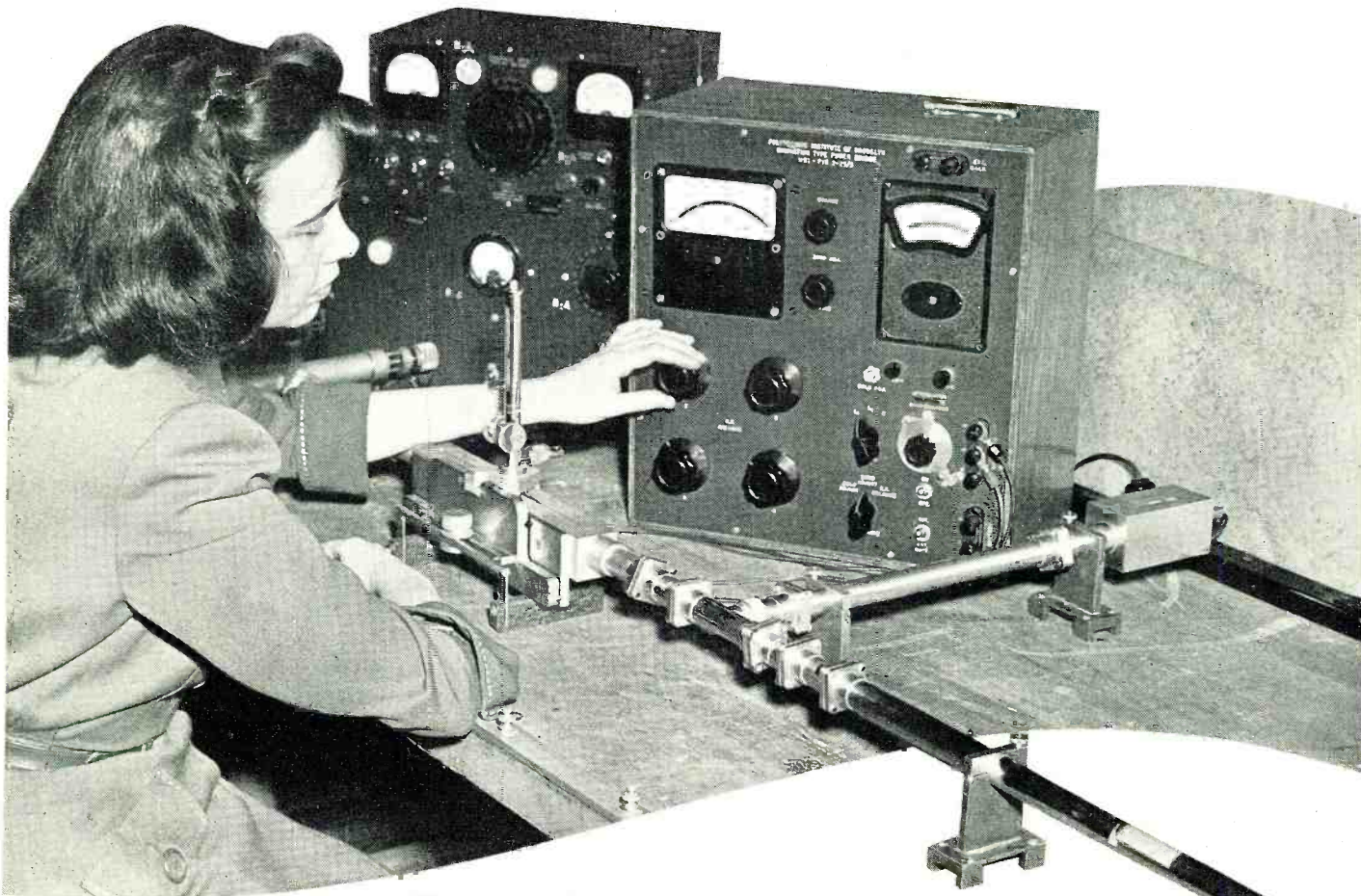

Fig. 5. Meter current variation.

Fig. 6. (A) Circuit of a phase comparator servo. (B) Circuit of a phase comparator using a meter as a null indicator with calibrated phase shifter.





Theory and practice of broadbanding bolometers for r. f. power measurement from 20 to 10,000 mc.

BROADBAND BOLOMETRIC MEASUREMENT of Microwave Power

By **HERBERT J. CARLIN**

Research Supervisor, Microwave Research Institute
Polytechnic Institute of Brooklyn

THE MOST usual practice in the application of bolometers for the measurement of r.f. power is to use a substitute procedure which equates low frequency power to microwave power. It is therefore desirable to consider the effect of r.f. vs. d.c. power distribution on measurement errors. Also since the bolometer may be thermally non-uniform along its length, this effect coupled with bolometer non-linearity, i.e., deviation from square law, must also be examined.

If the resistance of a bolometer per unit length is $r(x)$, where x is the bolometer length coordinate, then $r(x)$ will be a function of the power distribution $w(x)$.

$$r(x) = r_0 + f(w, x) \dots \dots \dots (1)$$

where r_0 is the constant resistance per unit length under ambient conditions. If the bolometer is used in a Wheatstone bridge circuit, the substitution principle of measurement gives:

$$R = \bar{R} \dots \dots \dots (2)$$

where R is the resistance with no r.f. impressed, and \bar{R} is the resistance with microwave power substituted for a portion of the bias power. The bias power withdrawn is presumed equal to the microwave power, and the validity of this assumption must be examined.

From Eqts. (1) and (2):

*The material in this paper was presented at The AIEE-IRE conference on High Frequency Measurements in Washington January 18, 1949. It is the result of research at the Microwave Research Institute of the Polytechnic Institute of Brooklyn, sponsored by the Watson Laboratories, AMC, USAF under contract W-33-038ac-13343.

$$R_T = \int_0^l r(x) dx = \int_0^l \bar{r}(x) dx = \bar{R}_T \dots \dots \dots (3)$$

so that:

$$\int_0^l f(w, x) dx = \int_0^l f(\bar{w}, x) dx \dots \dots (4)$$

where l is the length of the bolometer.

Eq. (4) follows if the distribution of r.f. and bias power over the bolometer cross-section are the same, i.e., negligible skin effect, for then $r_0 = \bar{r}_0$, and the functional form of "f" remains the same when either bias power or microwave power is applied.

In general Eq. (4) does not imply equivalence of r.f. and d.c. power, that is, the conclusion:

$$P = \int_0^l w dx = \int_0^l \bar{w} dx = \bar{P} \dots \dots (4a)$$

where P is total power, does not follow unless certain special conditions are

satisfied. Some of these will now be considered.

Suppose the r.f. and bias powers distribute along the bolometer length in the same way, then:

$$\bar{w}(x) = a w(x) \dots \dots \dots (5)$$

where a is a constant.

Then from Eq. (4):

$$\int_0^l f(\bar{w}, x) dx = \int_0^l f(a w, x) dx \dots (6)$$

and if f is monotonic in w , that is, changing w changes the bolometer resistance in a fixed direction—a property true of all bolometers whether non-linear or not—then for Eq. (6) to be valid, a must be unity. Hence at balance, $w = \bar{w}$, or:

$$P = \bar{P} = \int_0^l w dx = \int_0^l \bar{w} dx \dots (6a)$$

That is, for similar r.f. and bias power distributions, the substitution method is valid independent of bolometer non-linearity.

If the r.f. and bias powers are not similarly distributed, then Eq. (4a) will in general not be true. But suppose the bolometer resistance is linear in its response to w . Then:

$$r(x) = r_0 + a(x)w(x) \dots \dots \dots (7)$$

At r.f. balance Eq. (2) is satisfied, and therefore:

$$\int_0^l a(x)w(x) dx = \int_0^l a(x)\bar{w}(x) dx \dots \dots \dots (8)$$

If the bolometer is thermally non-uniform, that is, a varies with x , then if w and \bar{w} distribute differently, Eq. (8) does not imply $P = \bar{P}$, even though the bolometer is linear in w . However, if the bolometer is thermally uniform, then $a(x) = \text{constant}$, and it follows immediately from Eq. (8) that $P = \bar{P}$, independent of the way in which r.f. and bias powers are distributed.

If the bolometer is energized with pulsed r.f. power, additional errors may result. Consider Fig. 2A which shows a static resistance-power curve of a bolometer. When pulsed power is impressed, the resistance swings from its initial bias value R_0 , and has an average value over the cycle of R_{av} . If the R - P curve is linear, it can be shown that R_{av} is the value corresponding to an abscissa P_{av} (average of pulsed power). However, if the R - P curve is non-linear, then R_{av} differs from this and is located as shown in Fig. 2A. In applying the substitution scheme under ideal conditions, the bias is reduced until R_{av} coincides with R_0 , and the decrease in bias power is equated to the r.f. It can be seen from Fig. 2B, that if this is done with a non-linear bolometer curve, w_1 , the retracted power, is somewhat larger than the true average of the r.f. signal. Hence the bolometer non-linearity leads

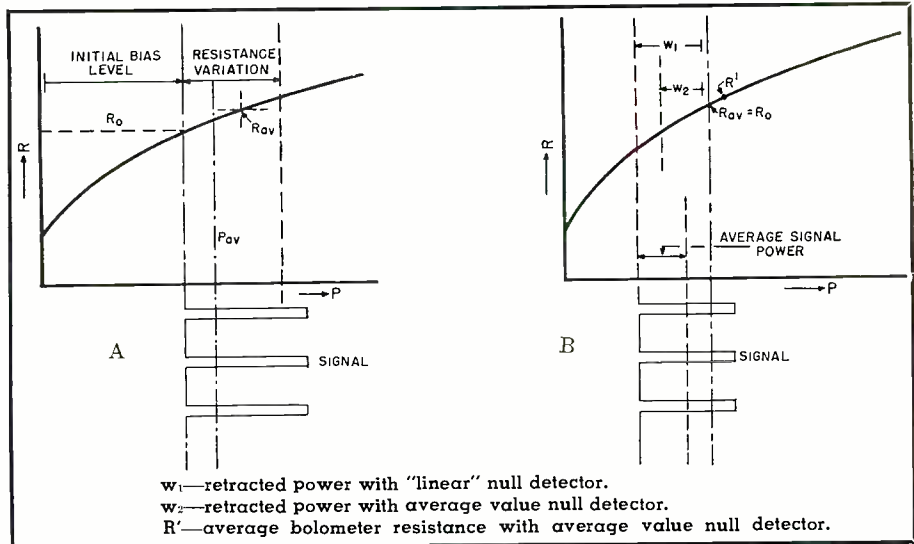

Fig. 2. Bolometer non-linearity error under pulsed power conditions.

to readings which tend to be high, if the R - P curve is similar to that shown in Fig. 2. This shape, incidentally, is typical of Wollaston wire and other positive temperature coefficient type bolometers.

Another cause for error due to modulation of the pulsed signal was pointed out by Moreno and Lundstrom.¹ This error is inherent in the usual Wheatstone bridge arrangement used in the substitution method and is present even with a perfectly linear bolometer. Fig. 3 is an oscillogram of bolometer resistance variation over the pulsing cycle. Because of this time variation of resistance, the Wheatstone bridge is continuously unbalanced, and an alternating component of current flows in the bridge detector. If $R(t)$ is the bolometer resistance, then the galvanometer current is given by:

$$i_g = A \frac{R_0 - R(t)}{C + R(t)} \dots \dots \dots (9)$$

where A and C are constants of the

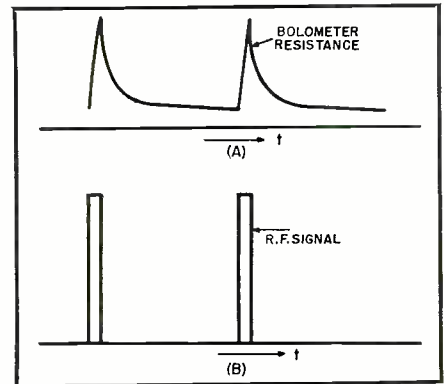

Fig. 3. Bolometer response to pulse power (Wollaston wire).

bridge, and R_0 is the bolometer resistance required for balance.

The condition of balance requires that the average galvanometer current be zero or:

$$I_{ga} = \frac{1}{T} \int_0^T i_g dt = \frac{1}{T} \int_0^T \frac{R_0 - R(t)}{C + R(t)} dt = 0 \dots \dots \dots (10)$$

Fig. 4. Microwave power meters with outer casing removed. Bottom, 4000 to 10,000 mc. unit; left, 20 to 1000 mc. unit; and right, 1000 to 4000 mc. unit.

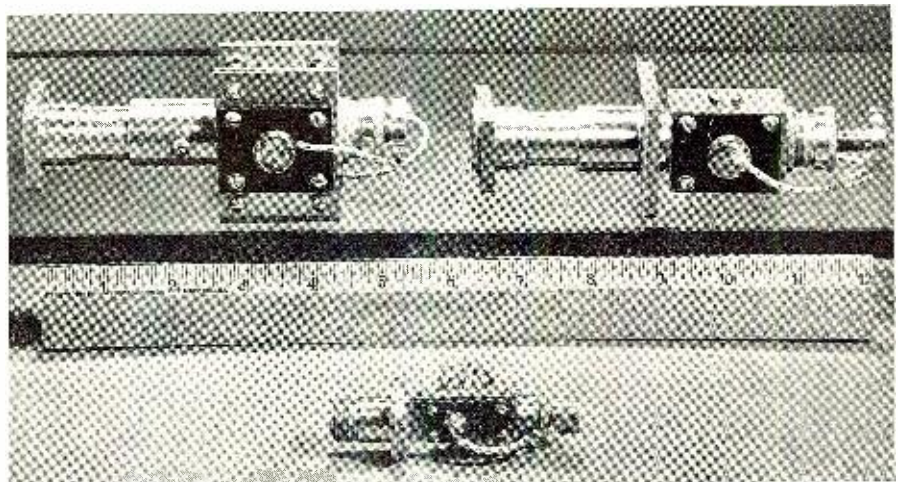

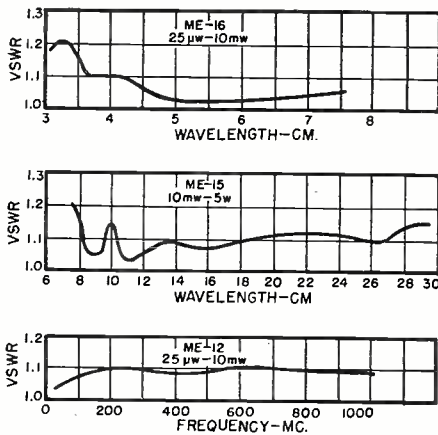

Fig. 5. Typical VSWR curves of broadband bolometer power meter heads.

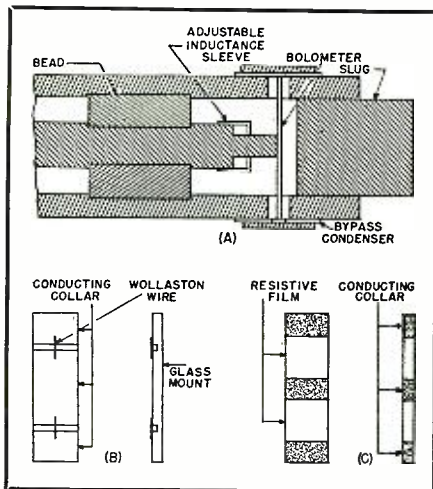

Fig. 6. (A) Assembly of bolometer power meter. (B) Wollaston wire bolometer. (C) Metallized film bolometer.

but $R(t)$ is non-linear in time, so that although at bridge balance Eq. (10) is satisfied, this in general will occur when:

$$R_{av} = \frac{1}{T} \int_0^T R(t) dt \neq R_0 \dots (11)$$

In other words under pulsed conditions, when the resistance excursion of the bolometer is large, the galvanometer current is not a straight line function of the bolometer resistance. Therefore the null of the detector does not correspond to the required average value of bolometer resistance, R_0 , and an error must result. Referring to Fig. 2B; bias power w_2 is withdrawn until the detector indicates a null, but the resultant average bolometer resistance due to the effect just discussed is R' instead of R_0 . Effectively then, insufficient power is withdrawn, and the reading is low. It is clear that this error occurs with a linear $R-P$ curve, but is smaller the larger the time constant. An analysis of this problem which takes into account both the finite bolometer time constant and $R-P$ curve non-linearity has been carried out by Mariotti,² and it is shown that the non-linear error and the "average" detector error tend to cancel when a typical Wollaston wire bolometer is used.

Summary of Desirable Bolometer Properties

1. Make bolometer short compared to wavelength, to insure similar r.f. and bias power distribution along the bolometer length.
2. Make bolometer thickness less than skin depth at the highest operating frequency and avoid proximity effects to insure similar r.f. and bias power distributions over the bolometer cross-section.
3. Make bolometer long compared to cross sectional dimensions to get uniform thermal properties.
4. Bolometer resistance vs. power curve should have a minimum of non-linearity.

Fig. 7. Performance of bolometer power meter without series tuning.

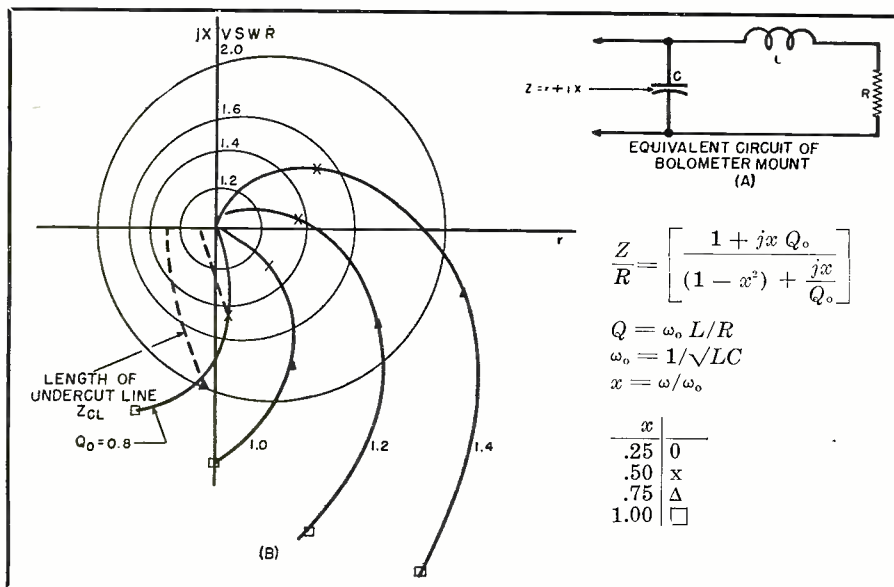

5. Bolometer should have long time constant to minimize "average" null detector error.

6. The bolometer in its casing should be matched over broad bands, with a fixed tuning adjustment.

Broad Band Operation of Bolometers

Broad banding of a bolometer is listed above as a desirable characteristic, and this deserves further consideration. An input standing wave ratio of 1.30 leads to a reflected power loss with a matched generator of 0.1 db. and this VSWR is felt to be a reasonable maximum value for broad band operation. A series of bolometer power meters has been developed at the Microwave Research Institute of the Polytechnic Institute of Brooklyn which meet this requirement and cover the frequency band 20-10,000 mc., and a power range of 25 microwatts to 5 watts. Typical VSWR curves for three of the power meters are shown in Fig. 5, and a photograph of these units is shown on page 17. Three additional units are used to complete the range coverage and standing wave ratio curves for these are similar to those shown in Fig. 5.

The development of these extremely broad band units represents the cooperation of many individuals, and acknowledgement of important contributions should be made to J. Ebert of the *Polytechnic Research and Developing Co.*, and M. J. DiToro and D. LeVine of the *Federal Telecommunication Laboratories*. The basic principles of design may be understood from Figs. 6 and 7. Fig. 6 shows the general construction of the bolometers and casings. There are two types of bolometer. One of these, the Wollaston Wire, is for the low range of power from 25 μ w. to 1 mw. (a 10 db. attenuator extends the range to 10 mw.). This has a sensitivity of approximately 6000 ohms per watt of r.f. The other is a metal film bolometer with a range from 1 mw. to 50 mw., (a 10 db. and a 20 db. attenuator extend the range to 5 watts) and a sensitivity of approximately 60 ohms per watt r.f.

Figure 6A shows the bolometer in its 50 ohm line casing. The resistance of each half is 100 ohms, and the bolometer is isolated from the outer conductor by means of the bypass condensers shown. Hence, the resistance to the external bridge circuit is 200 ohms, and the resistance to the r.f. line is 50 ohms. Associated with the bolometer mount at r.f. frequencies are parasitic reactances. Thus, the resistance element can be regarded as a short length of transverse transmission line which acts essentially as an inductance in series with the bolometer resistance. The conducting slug is effectively a

ground plane, and the inductance is approximated by:

$$L = \frac{\mu}{2\pi} \ln \frac{D_M}{D_s} \dots \dots \dots (12)$$

where D_M is the "geometric mean distance" between the bolometer and its image in the ground plane, and D_s is the "self geometric mean distance" of the bolometer element. As the tuning slug is moved back, the inductance increases, and as the wire diameter decreases the inductance also increases. In addition, the slug also has the effect of introducing a capacitance which shunts the bolometer, and the value of this capacitance is increased as the slug approaches the bolometer. Fig. 7A shows the equivalent circuit of the bolometer, and Fig. 7B shows typical calculated loci of the input impedance for various combinations of L and C corresponding to different slug positions. The curve for $Q = 0.8$ is the most desirable, for then a simple inductance in series with the circuit is capable of producing a broad band match. This inductance is realized by means of the undercut length of line shown in Fig. 6A. A good match can be obtained over a broad band by adding this inductance. In actual practice the inductance sleeve and the position of the back end short circuiting slug are adjustable as shown in Fig. 6A, and the optimum settings are determined experimentally by measurements over the band. These settings are then locked, and no further adjustments are necessary. It should be noted that the bolometer diameter must not be too small, for then the slug must approach too close to the element and the resultant shunt capacitance will be too high to permit proper matching at the high frequency end of the band. This is of major importance in the choice of proper wire to use for the Wollaston wire elements. In addition the slug must not be located too close to the bolometer wire since this affects the losses adversely. Assuming a wire above a conducting plane, the loss in the tuning slug is approximately given by:

$$\text{Slug loss} = \frac{A}{h} \dots \dots \dots (13)$$

where A is a constant which includes the effects of conductivity and skin depth, and h is the distance of the wire from the slug. If h is a minimum of $1/16"$, the losses in the slug are less than 1%. In the case of the metalized glass bolometer, the larger area associated with the metal film introduces an increased shunt capacitance effect and this must not be too large, for then the slug must be withdrawn too far for broad band matching. The final designs, with typical curves given in Fig. 5, were obtained by a long process of cut and try to effect the best com-

promise among all the factors involved.

On page 16 is a photograph of one of the power meters (shown enclosed in its casing) being used to terminate a high power attenuator. Shown in the picture is a d.c. bridge³ which in conjunction with the bolometer gives a direct reading of microwave power.

REFERENCES

1. *Moreno and Lundstrom, "Microwave Power Measurements", Proc. IRE, Vol. 35, No. 5 May 1947.*
2. *Mariotti, Master's Thesis, Polytechnic Institute of Brooklyn, June, 1948.*
3. *Carlin, H. J., and Blass, J., "A direct Reading D-C Bridge for Microwave Power Measurements", Proc. AIEE 1948, Vol. 67, Sec. T847.*

Frequency Divider

(Continued from page 9)

tained to within 0.001 per-cent of its assigned frequency. However, basically the center frequency oscillator circuit in an FM transmitter (direct modulation) is unstable in order to permit a shifting of its frequency in accordance with the modulation. Hence the problem here is how to make the oscillator insensitive to random effects but responsive to the modulation voltage.

A common method of locking in the center frequency, without affecting its ability to vary in frequency in accordance with the audio, is to lock-in its mean frequency with that of a stable

oscillator—such as a crystal oscillator. The two frequencies—that of the FM oscillator and the crystal oscillator—cannot be compared directly, however, since the FM signal contains a large number of sidebands, and therefore the carrier frequency cannot readily be detected. By frequency dividing the FM signal, most of these sidebands can be minimized—the higher the frequency division, the greater the percentage of carrier power in the signal.

For this reason, the center frequency of the Federal FM transmitter, for example, is divided 256 times. Heretofore, this was accomplished by utilizing 12 frequency divider and buffer stages and now it can be done in one stage. The appropriate submultiple of the center frequency is then compared with that of the crystal controlled frequency. Through the use of a balanced phase detector, any difference between the mean frequency of the carrier and that of the crystal is reflected in the output of the detector as a voltage whose magnitude is proportional to the frequency deviation. This voltage is then applied to the oscillator circuit and acts to correct or lock-in the center frequency of this oscillator to its required value.

The use of this circuit in television transmitters was indicated in the intro-

"THAT'S THE LAST PLACE I'D HAVE LOOKED FOR THE TROUBLE! IT'S IN THE COIL BASE!"

Yet the base is the first factor of your coil construction. However fine your coils are otherwise, they are no better than their bases. Make sure with the proved

PRECISION DI-FORMED PAPER TUBES

Today's standard thruout electrical industry. Round, square, oval, rectangular, any shape, length, ID or OD, exactly to your specifications.

Finest dielectric Kraft, Fish Paper, Cellulose Acetate or combinations. Spirally wound for greatest strength. Precision methods insure better heat dissipation—better insulation—moisture resistance—lightest weight—space saving.

Get all the facts. Send for samples and prompt estimate. New mandrel list 1,000 sizes. Ask about New Precision Di-Formed Tubes at no extra cost, for closer coil engineering, automatic stacking, many other advantages. Wire or write.

PRECISION PAPER TUBE CO.

2063 W. Charleston St., Chicago 47, Ill.
Plant No. 2, 79 Chapel St. Hartford, Conn.

duction of this article. Here again a substantial saving in tubes and a much simpler, readily adjustable circuit can be effected which means lower maintenance costs to the broadcaster. Unquestionably, the reader himself will think of numerous other potential applications of the circuit. The applications described are merely intended to serve as illustrations of the capabilities of the circuit.

Measuring Wear

(Continued from page 11)

The Bureau's apparatus employs a capacitor of the guard-ring type. In this device a high voltage electrode is supported at a fixed distance from a smaller measuring electrode, which is surrounded by a guard ring to eliminate fringing. The larger electrode is connected to the high-voltage terminal of a bridge, and the measuring electrode and guard ring to the ground-potential terminals of the same instrument. Only that portion of the total flux from the high-voltage electrode which reaches the smaller electrode is measured by the bridge. The island and guard ring are so constructed that the specimen can be clamped with its worn area over these parts. The third electrode is mounted in a heavy hinged lid which can be swung down to a fixed position above the specimen. This electrode forms part of the micrometer head for adjusting the distance between it and the island electrode to precise known values. The capacitor is very heavy and rigid to withstand the shocks of frequent use.

The capacitance method has many applications in addition to its use for simple abrasion testing. It may, for

example, be employed as a quick and accurate means for exploring the uniformity of textile materials. Also, it has been found very convenient for measuring quantitatively the wear of different parts of a garment that has been subjected to a service test. Values of Q may be obtained over an entire area of the garment, and a map of the area made by plotting "iso-ruin" lines through points of equal Q .

The capacitance method of measuring wear was developed at the Bureau for use with the improved Schiefer abrasion testing machine¹, which has been adapted for testing a large variety of materials under a wide range of conditions. The original model of the machine was designed by Dr. Schiefer in accordance with a mathematical solution to the problem of abrading a specimen uniformly in all directions.² This solution requires that plane areas of abradant and specimen, in contact under constant pressure, rotate in the same direction with the same angular velocity but on different axes. The later model has been designed for greater rigidity, and new types of abradants and specimen holders have been developed. Abrasive wear produced on a variety of materials with this model has been measured by the capacitance method and found to be extremely uniform over the abraded area. Results on woven fabrics have been shown to be very similar to those obtained in actual service.

REFERENCES

1. For further details, see "Improved single-unit Schiefer abrasion testing machine," Herbert F. Schiefer, Lawrence E. Crean, and John F. Krasny, which will appear in the May 1949 issue of the NBS Journal of Research.
2. "Uniform abrasion in the testing of textiles," NBS Technical News Bulletin 31, 70 (1947); see also J. Research NBS 39, 1 (1947) RP1807.

Three views of the apparatus developed at NBS for measuring the abrasive wear in a textile specimen from its change in capacitance. (A) The small cylinder at the left consists of the measuring electrode within a guard ring. Above is a heavy hinged lid containing the high-voltage electrode, and to the right is the specimen clamp with the specimen exposed at its center. The a. c. bridge below is used to measure capacitance. (B) The specimen has been set in place so that it is supported by the measuring electrode and guard ring. (C) The high-voltage electrode has been swung down to complete the assembly of the capacitor.

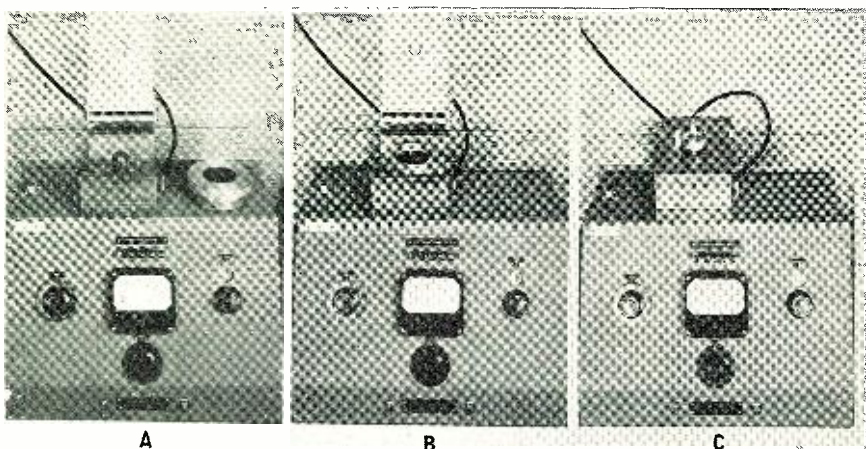

NEW TUBES

RCA TUBES

Fixed-tuned oscillator triode

The Tube Department of the Radio Corporation of America, Harrison, N. J., has announced the availability of the RCA-5794, a fixed-tuned, u.h.f. oscillator triode with two integral resonators



for use in radiosonde transmitters operating at 1680 mc.

One of the resonators is fixed-tuned and is attached between grid and cathode. The other is tunable over a narrow range centering at 1680 mc. and is attached between grid and plate.

Features contributing to the usefulness of the 5794 in radiosonde service, according to the manufacturer, include its compact metal construction, low battery drain, small frequency drift and high efficiency.

Multi-unit tube

Designed to provide for the detection and amplification of either AM or FM signals without switching detector circuits, the 12S8-GT is a multi-unit tube combining three diodes and a high- μ triode in one bulb.

One of the diodes has a separate cathode, while the other two diodes have a single cathode in common with the triode unit. The 12S8-GT is like the 6S8-GT except for heater rating of 12.6 volts and 0.15 ampere, as compared with 6.3 volts at 0.3 ampere.

Picture tube

The 16" diameter face of the 16AP4, metal-cone picture tube, provides a picture area of 132 square inches which is said to have high brightness and good contrast.

RCA's latest contribution to the television industry is the first metal television kinescope ever produced. The cone of this new tube is metal; the neck



and face plate are glass. The weight of the tube, 11 pounds, is substantially less than that of a similar all-glass tube.

Rectifier tube

Designed for use in r.f.-operated, high-voltage, low-current power supplies, the new 5825 half-wave rectifier tube is suitable for industrial and other applications requiring a rectifier having higher voltage-handling capability than the RCA-1B3-GT.

Among the design features of the 5825 is its thoriated-tungsten filament requiring only 2 watts. The filament can conveniently be isolated from ground by operating it either from a separate



winding on an r.f. transformer or from a resonant transformer excited by the capacitance current through the tube.

Beam power amplifier

For use in compact, low-power, mobile transmitters and in the low-power stages of higher-power, fixed-station transmitters, RCA offers the 5763. It is a v.h.f. beam power amplifier of the 9-pin miniature type, has a maximum plate dissipation of 12 watts and can be

operated with full input up to 175 mc.

In Class C service at 50 megacycles, the 5763 can deliver a useful power output of about 7 watts (CCS) with a plate voltage of 300 volts and a driving power at the tube of 0.35 watt.

Oscillograph tube

Intended for general oscillographic applications, the 3RP1 3-inch oscillograph tube is only 9 $\frac{3}{8}$ inches long. It utilizes electrostatic deflection and focus and its screen has medium persistence, green fluorescence and high contrast.

This new oscillograph tube is capable of providing high brightness when operated with an anode-No. 2 voltage near the maximum of 2500 volts and good brightness at relatively low anode-No. 2 voltages. Because of features incorporated in the "zero-current first-anode" gun, developed and introduced by RCA, the beam current and grid-No. 1 cutoff voltage are not affected by focusing adjustment.



Pulse amplifier tetrode

The 715-C is a pulse amplifier tetrode having a maximum plate-dissipation rating of 60 watts, and a maximum peak-plate-voltage rating of 18,000 volts.

It is also said to be capable of delivering a peak-plate-current pulse of 15 amperes in rectangular-wave modulator service when the duty factor is limited to 0.001.

V.H.F. power tetrode

Intended for modulator, power amplifier, and oscillator service, the 4-65A is a small, v.h.f. power tetrode with a maximum plate dissipation of 65 watts. The 4-65A can be used with full input at frequencies up to 50 megacycles and with reduced input up to 250 megacycles.

Features include a thoriated-tungsten filament and low interelectrode capacitances.

DEFLECTION AMPLIFIER TUBES

Hytron Radio and Electronics Corp., Salem, Mass., has announced two new horizontal deflection amplifier tubes, types 6BQ6GT and 25BQ6GT, designed for use in television receivers.

(Continued on page 28)

REGULATED POWER SUPPLIES

DESIGNED for use in industry, school and laboratory these power supplies are ruggedly constructed and conservatively rated for long and dependable service. Attractively styled and priced, these units have found wide acceptance. They are also available in complete kit form for maximum economy. The following characteristics apply to the models listed below:

Input: 105-125V/50-60cps/100 watts.
Output: Variable from 200 to 325VDC @ 100ma regulated, 6/3VAC CT @ 3A unregulated.

Regulation: Less than 1% no load to full load. Less than 1% for line voltage variation 105 to 125 volts.

Noise and Ripple Output: Less than 10 mv rms for above ratings.

Tube Complement: 5V4G, VR-105, 6SH7, 2-6Y6G.

DC Output Connections: Either positive or negative may be grounded.

BENCH MODEL 25



COMPACT AND LIGHT WEIGHT Functionally designed for maximum convenience in operation. Six sturdy, insulated, "5-way" output terminal posts. Grey finish. 14" wide, 6" deep, 8" high. Weight 17 pounds.

Model 25 \$39.95
Model 25K Complete kit 29.95

RACK MOUNTING MODEL 28



COMPACT UNIT FOR STANDARD RACK MOUNTING. Rear access terminal board. Panel 19" x 5 $\frac{1}{4}$ ". Black wrinkle finish (grey optional). Depth behind panel 7 $\frac{1}{2}$ ". Weight 16 pounds.

Model 28 \$34.95
Model 28K Complete kit 24.95

f.o.b. Corona, N. Y.

BASIC REGULATED POWER SUPPLY KIT MODEL 31K

Basic kit of parts for incorporation into equipment comprises cased power transformer and filter choke, oil-filled capacitors, sockets, resistors, tubes and schematic diagram.

Basic Kit 31K \$14.95



DEPT. ZD
CORONA

LAMBDA

ELECTRONICS CORP.
103-02 NORTHERN BLVD.
NEW YORK

NEWS BRIEFS

CARNEGIE INSTITUTE APPOINTS PROFESSORS

Five engineering and science faculty members of the Carnegie Institute of Technology have been promoted to full professorships, effective September 1st. Six new associate and three new assistant professors were also named.

Appointed to professorships in the College of Engineering and Science were Doctors Gerhard Derge, Frederick N. Rhines, Richard J. Duffin, James P. Fugassi and Everard M. Williams.

New Associate professors are Doctors John G. Fox, Roger B. Sutton, Charles O. Williamson, Wayne S. McKee, George R. Patterson, and Clara J. Douglas. William J. Leivo and Lincoln Wolfenstein were appointed assistant professors of physics in the College of Engineering and Science, and Althea L. Johnson was promoted to Assistant Professor of Chemistry in Margaret Morrison Carnegie College.

NEW COLUMBIA PLANT

To increase production, expand facilities and maintain a large stock on hand, *Columbia Wire & Supply Company* has moved into its own new and

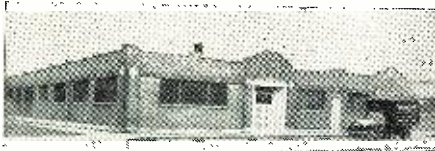

larger building at 2850 Irving Park Road, Chicago, Illinois.

Columbia serves the radio, electronic, electrical and many other industries with a variety of cord sets, wiring harnesses and various types of wire and wire products. The staff cordially invites those interested to visit the new plant.

FINISON JOINS ARMOUR RESEARCH

Former application engineer for the *General Electric Company*, Harvey J. Finison has been named assistant chairman of the electrical engineering department of Armour Research Foundation of Illinois Institute of Technology.

Mr. Finison was previously engaged in the development of electrical systems for aircraft, industrial power system engineering and industry application engineering. From 1940 until 1944 he

was in charge of the test program on electrical system performance on the B 29 bombers and was active in the development of electrical equipment for other military aircraft for the Air Material Command.

Mr. Finison will supervise Foundation work in electrical materials and measurements and the application of electrical systems in industrial control.

NBS PROGRAM

The National Bureau of Standards has appointed George C. Schleter to conduct an engineering development program on guided missiles, including missile systems and components in the Bureau's Electronics Laboratories. Well-qualified for the appointment, Mr. Schleter has a background of research in radio physics, mathematics and electronics, and was previously engaged in microwave research at the Naval Research Laboratory.

For its work on basic research, design and development of electronic computers, the Bureau has announced that Dr. Ralph J. Slutz has joined the Electronics Division. Formerly with the Institute for Advanced Study, Dr. Slutz has done extensive research in electronics, electronic computers, elasticity and terminal ballistics.

APPOINT ENGINEERS TO IRE COMMITTEES

Six engineers of the *Stromberg-Carlson Company* have been appointed to technical committees of the Institute of Radio Engineers.

Those appointed and their respective committees are: Oliver L. Angevine, Jr., audio techniques; Benjamin Olney, electroacoustics; Charles W. Finnigan, modulations systems; Garrard Mountjoy and Albert R. Hodges, receivers.

Also appointed to the committee on receivers is F. H. R. Pounsett, chief engineer of *Stromberg-Carlson Limited* in Toronto.

NAME RESEARCH ASSOCIATE

Stanford Research Institute has appointed Frank W. Clelland, Jr., as a research associate on its electrical engineering staff where he has been assigned to projects on communications equipments.

Mr. Clelland spent several years as a

staff member of the Kerr group on microwave propagation in the Radiation Laboratory of Massachusetts Institute of Technology where he undertook studies on the anomalous propagation of microwaves, as effected by atmospheric conditions.

A member of the Institute of Radio Engineers, Mr. Clelland received his A.B. degree from Oberlin College, Oberlin, Ohio.

MONSANTO USES TV FOR PLANT TOUR

Monsanto Chemical Company used a unique method recently when it presented a televised plant tour to visitors

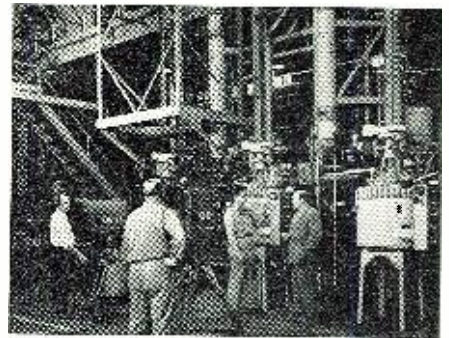

at the American Wood Preservers' Association convention in St. Louis. Facilities of Station KSD-TV were used for this unusual program.

Remote television equipment was moved into *Monsanto's* new research pilot plant and the plant tour was televised to the convention headquarters at the Hotel Jefferson where it was received on both large-screen projection and smaller direct view sets.

This first industrial on-the-spot television program included interviews with *Monsanto* chemists as they demonstrated some of the functions of the pilot plant and of their various products.

NEW PLANT

Resistors, Inc., Chicago, one of the newer manufacturers of resistors for radio and electronic circuits, has moved into its new plant located on Chicago's industrial far west side.

The new building is a one-story daylight plant and said to be designed



specifically for fast production of highest quality resistors. According to Joseph J. Cerny, Founder and President, *Resistors, Inc.*, has made rapid progress in its first three years of operation and

the move to its new plant means one hundred per-cent increase in production capacity.

Their new address is: *Resistors, Inc.*, 5226 West 26th St., Chicago 50, Illinois.

ROGER M. WISE, INC., JOINS PHILCO

The *Philco Corporation* of Philadelphia, which is acquiring the assets of *Roger M. Wise, Inc.*, has announced that Mr. Wise and his group of experienced tube engineers have joined their technical staff. The personnel of the Wise organization, formerly located at Rockville Center, N. Y., will occupy new laboratories in the expanded modern plants of the *Lansdale Tube Co.*

Mr. Wise was active during World War II in designing special receiving tubes, cathode ray tubes and transmitting tubes, as well as development and production of subminiature tubes for the famous VT proximity fuzes. Among other leading engineers who are joining Philco along with Mr. Wise are H. Kenneth Ishler, Joseph J. Grabiec, E. J. Hoffman, Dr. Philip Hambleton and Stuart L. Parsons.

NEW LITERATURE

Instrumentation for Radioactivity

A complete new catalog of thirty-six pages of instrumentation for radioactivity measurement has just been released by *Nuclear Instrument and Chemical Corporation*, 223 West Erie St., Chicago 10, Illinois.

This Catalog J describes not only the wide range of instruments and accessories available, but also gives information about applications, manufacturing methods and other pertinent matters. Copies will be supplied upon request.

Rectifier news

The *International Rectifier Corporation*, Los Angeles, California, has announced the publication of the first issue of the "Rectifier News," identified as RN-349.

This four-page periodical will feature technical articles, photographs, circuit diagrams, etc., concerning new developments in the field of dry-plate (especially selenium) rectifiers for converting a.c. to d.c.

Regular subscriptions to this periodical are available to all qualified persons in the engineering profession without charge who send their request on company stationery to *International Rectifier Corporation*, 6809 So. Victoria Avenue, Los Angeles 43, California.

Standard for instruments

The new American Standard for Electrical Indicating Instruments, C39.1-1949, presenting requirements for

the individual sizes of panel and switch-board instruments is now available.

In addition to definitions and detailed requirements for each type of instrument, the text of the standard includes general requirements and test requirements for temperature, effect of overload, shock, vibration, humidity and a dielectric test. This new standard is Part 1, covering only panel and switch-board instruments. Part 2, covering a standard for portable instruments, will be released later.

Copies of the American Standard for Electrical Indicating Instruments may be obtained from the American Standards Association, 70 East 45 St., New York 17, N. Y. at \$1.50 per copy.

Electronic systems

The Office of Technical Services of the Department of Commerce has released a report prepared by the Oak Ridge National Laboratory of the Atomic Energy Commission describing devices used in measuring the energy distribution of alpha particles released from radioactive isotopes.

PB 96413, entitled "Electronic Classifying, Cataloging and Counting Systems" has applications to any field of observational science where the physical magnitude of the events under consideration can be electronically recorded. This report is 15 pages including

illustrations and diagrams and is available from the Office of Technical Services, Department of Commerce, Washington 25, D. C., at 10c per copy.

Medical X-Ray Protection

A handbook presenting recommended standards of safety for the installation and use of high-voltage x-ray equipment, written by a subcommittee of the National Committee on Radiation Protection, has been published by the National Bureau of Standards.

Rules are given for working conditions, survey and inspection of installations, planning an x-ray installation, structural details of protective barriers and specific types of installations. Also included are tables and graphs for determining the requirements of protective barriers and distance protection in specific cases.

One of the most interesting chapters is one on electrical protection which treats such topics as high-voltage circuits, grounding inspection and maintenance, warnings and instructions, and first-aid and fire-extinguishing devices.

Medical X-Ray Protection up to Two Million Volts, National Bureau of Standards Handbook 41, is obtainable from the Superintendent of Documents, U. S. Government Printing Office, Washington 25, D. C. at a cost of 15¢.

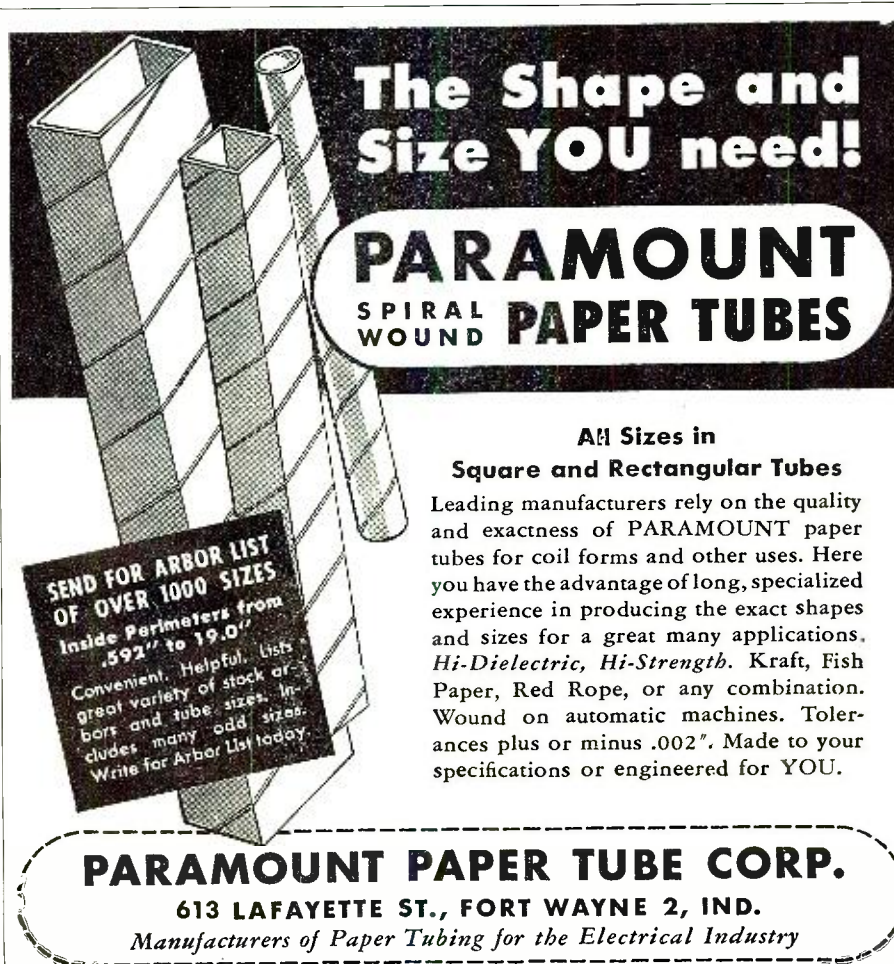

The Shape and Size YOU need!

PARAMOUNT
SPIRAL WOUND PAPER TUBES

All Sizes in Square and Rectangular Tubes

Leading manufacturers rely on the quality and exactness of PARAMOUNT paper tubes for coil forms and other uses. Here you have the advantage of long, specialized experience in producing the exact shapes and sizes for a great many applications. *Hi-Dielectric, Hi-Strength.* Kraft, Fish Paper, Red Rope, or any combination. Wound on automatic machines. Tolerances plus or minus .002". Made to your specifications or engineered for YOU.

SEND FOR ARBOR LIST OF OVER 1000 SIZES
Inside Perimeters from .592" to 19.0"
Convenient, Helpful, Lists great variety of stock arbors and tube sizes. Includes many odd sizes. Write for Arbor List today.

PARAMOUNT PAPER TUBE CORP.
613 LAFAYETTE ST., FORT WAYNE 2, IND.
Manufacturers of Paper Tubing for the Electrical Industry

NEW PRODUCTS

MOTOR CONTROL UNIT

An economical electronic control system for the stepless speed control of fractional horsepower motors has been



developed by *Servo-Tek Products Co.*, 4 Godwin Avenue, Paterson 1, N. J.

Operating from either a 110 or 220 volt a.c. power source, the power unit utilizes full wave gaseous rectification to supply both the armature and the field of a specially designed ball bearing d.c. motor. Two models are available which include various type motors up to and including $\frac{1}{2}$ hp.

Further information on this control unit may be obtained by writing direct to the company.

ISOLATION UNIT

RCA Engineering Products Department has announced a new FM-AM Isolation Unit for use to transfer FM power across the insulating zone of an AM antenna tower to feed an FM antenna mounted atop the tower.

Weighing less than half that of *RCA's* previous unit of this type, it provides complete isolation of FM and AM signals and efficient operation over the entire FM frequency range. Equipped with swivel flanges at both

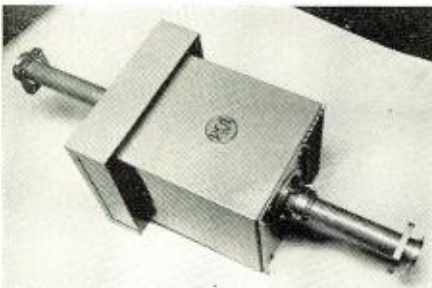

input and output, this unit may be easily and economically installed without any special expensive coaxial fittings.

Inquiries should be addressed to *RCA Engineering Products Dept.*, *RCA Victor Division*, Camden, N. J.

SURVEY METER

The Instrument Division of *The Kelley-Koett Mfg. Co.*, Covington, Kentucky, has announced their new Model K-320 Alpha-Beta-Gamma Portable Survey Meter. It is an improved version of the original Landsverk-Wollan survey-meter developed by the Manhattan District, predecessor of the U. S. Atomic Energy Commission.

The manufacturer states that the outstanding feature of the new survey-meter is the greater accuracy of radiation measurements obtainable. They



further state that the sensitive quartz-fibre electrometer construction permits unusually accurate measurements of gamma radiation in the two ranges of 100 mr./hr. and 1000 mr./hr.

Further details, including description of this unit, are available on request from the Instrument Division, *The Kelley-Koett Mfg. Co.*, 212 W. Fourth Street, Covington, Kentucky.

DISPLAY FACSIMILE

The *Stewart-Warner Electric Division* of *Stewart-Warner Corporation*, Chicago is producing a display facsimile receiver designed for use in public places to be sold or leased by station or publisher for programming news, features and advertising.

The recorder, or receiver, receives sound and facsimile programs simultaneously without interference to either service and provides completely unattended service. The manufacturer states that it will operate approximately three weeks, with four 15-

minute or four-page editions per day, on one loading of facsimile paper.

The FM sound transmission is carried by the unit continuously during all broadcast periods of the station to which the unit is pre-tuned. A time clock turns the entire unit on and off at the beginning and end of the broadcasting day. The unit conforms to all



FCC standards for facsimile and is housed in a cabinet of hard wood construction. It is $30\frac{3}{4}$ inches deep, $24\frac{1}{2}$ inches wide and $73\frac{1}{2}$ inches high when fitted with the four-page display top.

PHASE METER

A completely electronic instrument for the direct measurement of the phase difference between two voltages has been developed by the *Technology Instrument Corporation*, Waltham, Mass.

The Type 320-A Phase Meter, according to the manufacturer's reports, makes possible phase angle and phase distortion measurements which heretofore have been impractical to perform. Applications of the instrument include audio facilities, supersonics, servomechanisms, geophysics, acoustics, aerial navigation, electric power transformation and signaling.

A bulletin describing the Type 320-A Phase Meter is available by writing *Technology Instrument Corp.*, 1058 Main Street, Waltham 54, Mass.

GEIGER COUNTER

A Geiger counter for prospecting which is sensitive to both beta and



gamma radiation has been developed by the *Precision Radiation Instruments Inc.*, Chicago, Ill.

According to the manufacturer, this Geiger counter is suitable for laboratory work where auditory monitoring is used, but is designed primarily for field use in locating radioactive ores, where extreme light weight and small size are important. The weight is approximately 2 lbs. complete including battery and the size is only 2 3/4" x 3 1/4" x 6".

Precision Radiation Instruments Inc., 1101 North Paulina St., Chicago 22, Illinois will furnish further information upon request.

SELENIUM RECTIFIER CELLS

High-voltage selenium rectifier cells designed for a d.c. voltage of 24 volts per cell with an r.m.s. a.c. voltage of 33 volts per cell for single-phase bridge

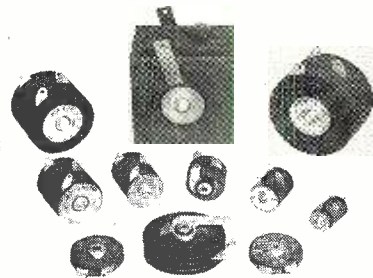

circuits have been announced by the *Westinghouse Electric Corporation*.

Available in six round sizes from one to 4 3/8 inches in diameter and in five-inch-square and 4 1/4 by 6 inch sizes, these selenium cells are applicable in radio transmitters, both sound and video, communication services, electrostatic precipitator power supplies, industrial supplies for electronic control, etc.

Further information on these selenium cells may be obtained from the *Westinghouse Electric Corporation*, P. O. Box 868, Pittsburgh 30, Pa.

PHOTOELECTRIC CELLS

A complete new line of unmounted selenium self-generating photoelectric cells has been developed by the *International Rectifier Corporation*, Los Angeles, California.

According to the manufacturer, these cells have found wide use in such applications as photographic exposure

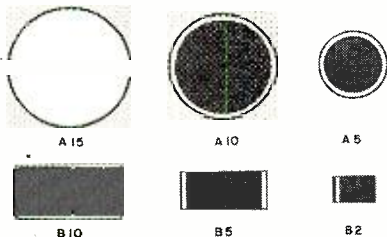

meters and illumination meters, since no external battery or power supply is

required for operation. The individual cell sizes vary from the rectangular 23/32" by 7/16" to the round type 1 3/4" in diameter.

Among the many applications for these cells are the reproduction of speech and music on the sound track of motion picture film, machine safety devices, counting and grading of products on the conveyor line and operating relays for turbidity and color control.

Additional information may be obtained by writing the *International Rectifier Corporation*, 6809 S. Victoria Avenue, Los Angeles 43, California.

SYSTEM ANALYZER

Weston Electrical Instrument Corporation, Newark, N. J., has announced an analyzer designed specifically for communication system maintenance. Listed as the Model 779, Type 5, this new analyzer measures low level speech circuits with a minimum of disturbance. It is entirely self-contained, requiring no power line connection.

Designed in cooperation with railway signal and telephone engineers, the analyzer makes dbm. readings at all audio and carrier current frequencies. The instrument is protected by a solid oak portable carrying case.



Complete information and technical data may be obtained by writing the *Weston Electrical Instrument Corporation*, 617 Frelinghuysen Avenue, Newark 5, N. J.

NOISE GENERATOR

The Type 810-A Noise Generator, manufactured by *Hermon Hosmer Scott, Inc.*, Cambridge, Mass., is a compact and inexpensive source of random noise for use in research engineering and production testing.

This noise generator is conveniently operated with the Type 20-A Power Supply and uses one 6C4 and one 6D4 tube. It has an audio-frequency output voltage from 0 to 0.2 and frequency range is 30 to 500,000 cycles in the
(Continued on page 26)

TECHNICAL BOOKS

"HANDBOOK OF PATENTS"

by Harry Aubrey Toulmin, Jr. Published by *D. Van Nostrand Co., Inc.*, 250 Fourth Ave., New York, N. Y. 800 pages. \$9.00.

Here is a practical reference book dealing with the essentials of patent law which will serve as a guide for the layman or the professional man to get a clear, over-all view of the subject. The steps that must be taken, from investigating the novelty of an idea through preparing a patent application, prosecuting it to an issued patent, and thereafter protecting it by litigation in the courts are all thoroughly covered.

Of special interest are the chapters on foreign patents and the treaties and conventions dealing with patents to which the United States is a party. Subjects covered include Constitutional and Statutory Patent Laws, Patent Fundamentals, How to Draft a Patent Application and Prosecute It in the Patent Office, How to Investigate Patent Records to Protect Rights, Misuse of Patents and Unusual Penalties.

Several pages are also devoted to questions and answers and an introductory orientation statement is placed at the beginning of each major chapter for easy reference.

"PATENT LAW," Second Edition, by Chester H. Biesterfeld. Published by *John Wiley & Sons, Inc.*, 444 Fourth Avenue, New York 16, N. Y. 267 pages. \$4.00.

Changes in patent laws during the past five years and the considerable number of important court decisions have made the revised edition of this text necessary.

Revisions have been extensive. The chapter on "Uses" is entirely rewritten with a more complete list of authorities; also an article on "Products of Nature" has been added. The discussion of "Double Patenting" is restated; and that of "Disclaimer" has been redrafted in view of new decisions.

The second edition, like the first, has been designed for researchers, chemists, engineers, patent attorneys and inventors, and presents the basic principles of the substantive patent law complete with a careful selection from the leading decisions in support of these principles. Recent decisions are arranged in groups to illustrate the various phases of the subject of invention according to the modern idea of the courts.

Here is an important volume of modest size in terms the general reader can understand.

New Products

(Continued from page 25)

r.f. range and 30 to 20,000 cycles in the a.f. range. A switch enables a noise output to be obtained conforming to "Noise of a General Character" as specified by the American Standards Association. This range is particularly useful for calibrating sound level meters.

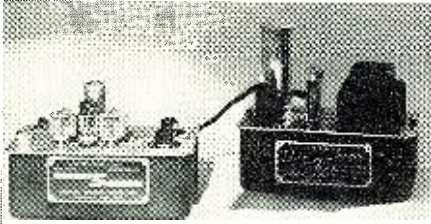

Inquiries should be addressed to *Hermon Hosmer Scott, Inc.*, 385 Putnam Avenue, Cambridge 39, Mass.

TESTING INSTRUMENT

The *Instron Engineering Corporation*, 2 Hancock Street, Quincy 71, Mass., is now producing the *Instron Tensile Tester*, a precision instrument based on electronic principles that make possible the accurate load-elongation measurements of plastic and textile materials, wire, paper, rubber, adhesives and similar specimens.

Full scale load range of this unit extends from 2 grams up to 5000 pounds in some models. A variety of unique testing techniques is available for the determination of special properties, as well as for routine measurements, because of the flexibility of the controls. Instantaneous starting, stopping, and reversal of direction of travel of the



moving jaw are effected through fast-acting computer-type magnetic clutches operating on the reference unit.

Chart speeds range from 0.2" to 50" per minute, which, in combination with the available head speeds, provide mag-

nification ratios up to one thousand to one.

R. F. POWER SUPPLY

Embassy Engineering Co., New York, has developed a high voltage r.f. power supply for use in projection television, cathode ray oscillography, electron precipitation, high speed flash photography, insulation breakdown testing and general experimental work.

According to the manufacturer, the many features include: low and high voltage units mounted on same chassis, high voltage completely shielded including external cables, tunable corona free r.f. filament transformers, pilot light indicator, and unconditionally guaranteed.

The *Embassy* r.f. power supply comes in two models. Model TV 201 is de-

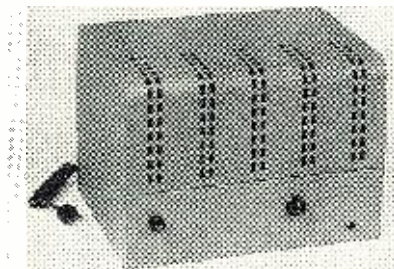

signed for television use in conjunction with the 5TP4 and other type projection tubes. Model ST 202 is the standard model for general research application.

Additional information may be had by writing *Embassy Engineering Co.*, 224 East 204th St., New York 58, N. Y.

SOLENOID-OPERATED SWITCH

Soreng Manufacturing Corp., Chicago, has announced a solenoid-operated switch designed to give synchronized control of two separate circuits. This unit consists of a normally open DPST switch, with a powerful *Soreng* TT type solenoid as the actuating mechanism.

Ideal for use in a wide variety of current control applications, this unit is said to remain in perfect working condition after 100,000 actuations carrying a load of 25 amperes at 250 volts a.c.

Additional information may be obtained by writing to P. H. Korrell, *Soreng Manufacturing Corp.*, 1901 Clybourn Avenue, Chicago 14, Illinois.

RECORDING ASSEMBLY

Offner Electronics, Inc., Chicago, Ill., has announced that it is manufacturing a new direct ink-writing oscillograph called the *Dynograph*. This recorder may be used for direct recordings in a wide variety of applications when used with Type 133 amplifier shown.

Of the many features of this new recorder, the sensitivity is approximately 150 microvolts per centimeter

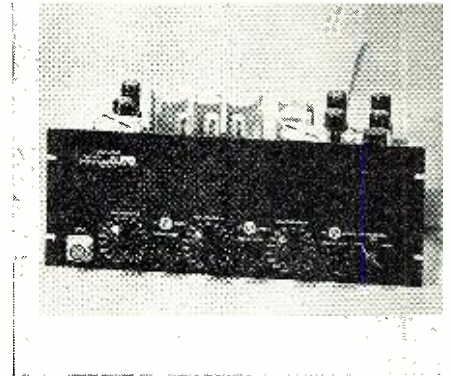

and the response time of the pen is less than 1/100 second. The *Dynograph* paper drive is six speed and is operated by a synchronous motor. Several Type 133 amplifiers may be used with a single *Dynograph* assembly for any number of recording channels desired.

DUAL BEAM OSCILLOSCOPE

The *Beam Instruments Corp.*, New York, has announced the availability of two new oscilloscope models manufactured by *Cossor* in England.

Model 1035, illustrated, shows two traces with independent vertical amplifiers. Featured are precision direct reading dial calibration of time intervals and amplitude for all gain and sweep switch positions, triggered sweep and 10 mc. bandwidth. Actinic blue,

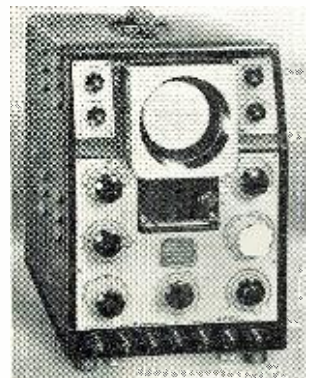

visual green or long persistence screens are available.

The other model 1049, not illustrated, is similar but features d.c. amplification.

Complete details may be obtained from *Beam Instruments Corp.*, 55 West 42nd Street, New York 18, N. Y.

SMOKE INDICATOR ALARM

Ideally suited for hotels, factories, hospitals, apartment buildings, etc., where breaching of the boiler does not exceed 10 feet in width is the *Economy Smoke Alarm* manufactured by *De-Tec-Tronic Labs., Inc.*, Chicago.

This indicator alarm provides a low cost photoelectric indicator of smoke density passing through the flue of a boiler and signals when density of the smoke exceeds a predetermined value.

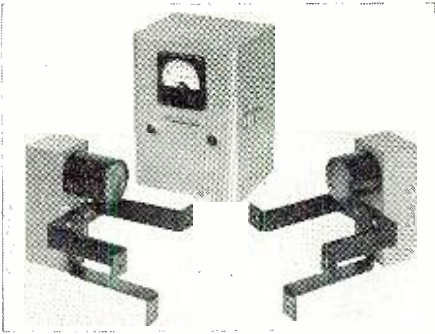

The operation and installation of this smoke indicator alarm is said to be simple.

For further information write *De-Tec-Tronic Laboratories, Inc.*, 1227 N. Clark St., Chicago 10, Ill.

OSCILLO-RECORD CAMERA

A new Oscillo-Record Camera incorporating a number of improvements has been announced by *Fairchild Camera and Instrument Corporation*, Jamaica, N. Y.

Among the improvements which have been designed to provide better operation are: "Swing-away" film rollers, self-oiling bearings, extra support on drive mechanism plate, additional foot on camera cover casting, tell-tale indicator, separate transformer winding and dynamic braking to bring film to

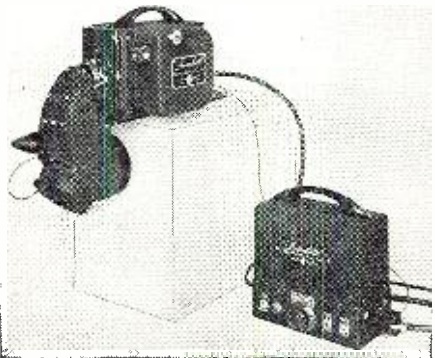

virtually instantaneous stop when electronic control unit is switched to "off" position.

W. J. Schubert, *Fairchild Camera and Instrument Corporation*, 88-06 Van Wyck Boulevard, Jamaica 1, New York will supply further information upon request.

FLUTTER AND WOW METER

A Flutter, Wow and Drift Percentage Analyzer, Model 491, Type A, is now in production at *Amplifier Corp. of America*, New York, N. Y. This sensitive measuring device was en-

(Continued on page 28)

Personals

DR. F. STANLEY ATCHISON, who has been with the National Bureau of Standards since 1942, has been appointed Chief of the Missile Intelligence Section. Dr. Atchison has worked in nuclear physics, in the design of radio proximity fuzes for bombs, rockets, and mortars, and in the design of electronic systems for guided missile control at NBS. He is a member of the American Physical Society and Sigma Xi.



PAUL W. ERICKSON, formerly supervisor of production engineering and then general foreman in charge of microwave tubes of *Sylvania Electric Products, Inc.*, has been appointed manufacturing superintendent for the Electronics Division at Boston. Mr. Erickson joined the staff of *Sylvania* in 1933 as a product engineer on radio receiving tubes at Emporium, Pa., and was later transferred to the company's radio tube plant at Salem, Mass.



ARTHUR B. GOETZE has been appointed works manager of *Western Electric Company's* Tonawanda Plant in Buffalo, N. Y., the 42nd Street Shops in New York City and the Allentown Plant in Allentown, Pa. Mr. Goetze, who has served in various executive capacities during his many years with the company, replaces William K. Wiggins who is retiring. A World War I veteran of the U. S. Navy, Mr. Goetze is a member of the Railway-Machinery Club of New York.



HARVEY W. LANCE has been appointed to the Missile Intelligence Laboratory of the National Bureau of Standards where he will be concerned with electronic systems for guided missiles. Mr. Lance was formerly on the teaching staffs of George Washington University and Pennsylvania State College. He is a member of the American Physical Society, the American Association of Physics Teachers, and the Institute of Radio Engineers.



FRANK R. NORTON, who has served as principal research engineer at *Bendix Aviation Corporation*, Baltimore, Md., has been appointed Chief Engineer of the *Bendix* Radio-Television and Broadcast Division. Mr. Norton holds original patents on television sweep circuits and has done some development work in color television for *Bendix* Radio Division. He is a senior member of the IRE, also the Society of Motion Picture Engineers.



WILLIAM M. PIPER, formerly with the Office of Chief Signal Officer, Department of the Army, will do research in the Ordnance Mechanics Laboratory of the Electronics Division at NBS. Mr. Piper has designed and built electronic test equipment, including wide-range video amplifiers and high-fidelity public address systems. A native of Coldspring, Wisconsin, he is a member of Pi Mu Epsilon, and a past member of the AIEE.



New Tubes

(Continued from page 21)

The 6BQ6GT with its 6.3-volt heater is for use in transformer-operated sets. The 25BQ6GT has a 25-volt heater and is suitable for use in sets employing series heater connections.

For further information write Commercial Engineering Dept., *Hytron Radio & Electronics Corp.*, Salem, Mass.

SUBMINIATURE TUBES

A portable battery radio receiver complement comprised of four types of subminiature tubes is announced by the

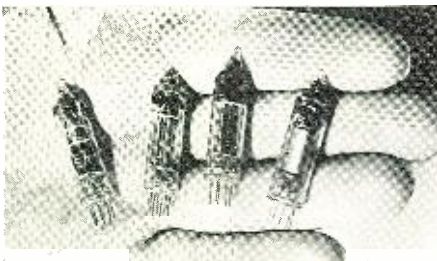

Radio Division of *Sylvania Electric Products, Inc.*, 500 Fifth Ave., New York 18, N. Y.

This subminiature tube group includes a 1AD5 sharp cut-off r.f. pentode; 1E8 pentagrid converter; 1T6 diode pentode; and IAC5 output pentode. All four tubes are designed for plate voltages ranging from 30 volts to 67.5 volts and plate currents ranging from 0.30 ma. to 2.0 ma.

INDUSTRIAL RECTIFIER TUBE

National Electronics, Inc., Geneva, Ill., has announced an inert gas-filled 2.5 ampere rectifier tube designed for industrial electronic applications where operation under widely varying temperatures is required.

This tube, NL-614, has a filament voltage of 2.5; filament amperes, 8½; d.c. amperes output, 2.5; peak current output, 15 amperes. The tube is offered under a long life warranty policy guaranteeing the use of a minimum of one year's operation regardless of hours.



BALLAST TUBE

A ballast tube for aircraft radio designed to withstand the vibrations encountered in aircraft, as well as other

types of mobile radio receivers and transmitters, has been announced by *Amperite Co. Inc.*, New York.

This tube will withstand 40 g. and can be supplied to dissipate up to 25 watts and in current values from 60 ma. to 3 amps. Diameter of the tube is 1¼", weighs 2 oz. and has standard radio octal base.

Amperite Company, Inc., 561 Broadway, New York 12, N. Y. will supply further information upon request.

New Products

(Continued from page 27)

gineered to comply with the tentative standards set by the Society of Motion Picture Engineers.

This analyzer was designed to fill the need for a simple, rapid, foolproof and accurate method of visual indication of wow, flutter and drift content of all types of 33⅓, 45 and 78 r.p.m. discs; 16 and 35 mm. sound film mechanisms, acetate film recorders, magnetic wire and tape recorders and playback equipment.

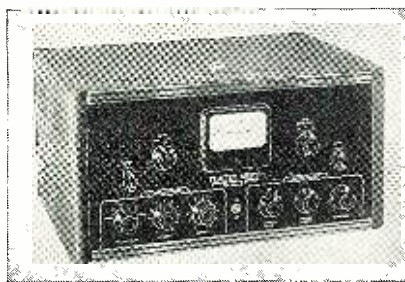

For complete descriptive literature and technical specifications, write to Test Equipment Division, *Amplifier Corp. of America*, 398-2 Broadway, New York 18, N. Y.

DUPLICATING MACHINE

A large volume Whiteprinter for reproducing anything drawn, typed, written, or printed upon translucent mediums at speeds up to 105 square feet per minute has been developed by the *Charles Bruning Company*, Chicago, Ill.

Called the Volumatic Model 93, it produces direct positive prints directly from the original drawing or document without intermediate steps. Prints from post card size up to those 42" wide and any length can also be made on the same machine.

Many useful features of the Bruning Volumatic Model 93 include a built-in constant voltage transformer as standard equipment which saves time, prevents print spoilage and assures uniform prints at all times. The Volumatic needs no special training to operate and is easily installed as it is self-contained and can be moved on its casters wherever needed.

Full information about the Volumatic Model 93 is given in Bulletin No. A-1053

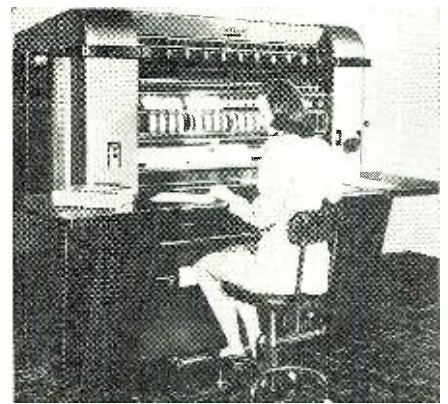

which can be obtained from the *Charles Bruning Company*, 4754 W. Montrose Ave., Chicago 41, Illinois.

MELTING FURNACE

A complete metal melting furnace for babbitt, solder, lead or wax and insulating compounds, the Metal Re-Melter, has been introduced by *The Nolan Corporation*, 1333 East Dominick Street, Rome, N. Y.

The *Nolan Metal Furnace* is square in design and requires less floor space than the conventional round furnace. Two standard models are offered, the Nolan "2000" which has a one-ton capacity metal pot and the Nolan "650" which has a 650 lb. capacity. Both machines are complete, compact units equipped with hinged cover, ventilating pipe connection and may be equipped for heating by electricity, oil or any type of gas. These furnaces can be furnished with larger capacity pots in sizes up to five tons.

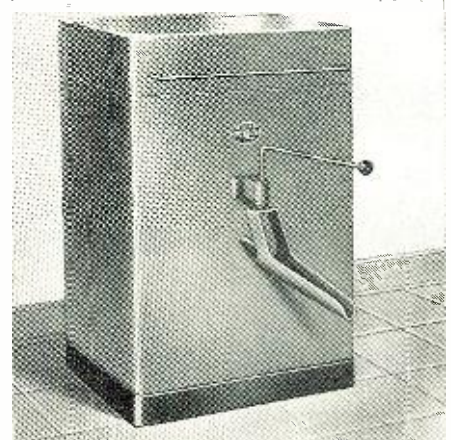

Bulletin describing the *Nolan* furnace may be obtained by writing to *Nolan Corporation*, 1333 East Dominick St., Rome, N. Y.

TIMING MOTOR

A new primary time-power source for direct current applications combining the accuracy of a clock with the power of a motor has been developed by *The*

A. W. Haydon Company of Waterbury, Connecticut.

Series 5500 and 5700 d.c. motors with a specially designed marine-type clock escapement governor are now being produced by the company. This escape-

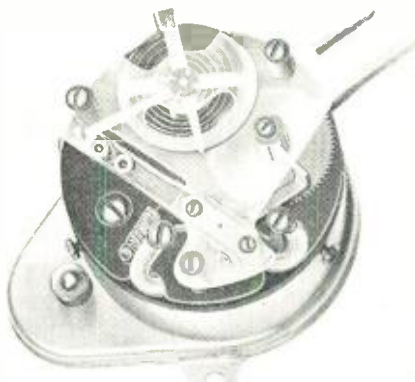

ment has the great advantage of minimum size and weight and is said to be unaffected by wide variations in voltage, load and temperature.

RECORDING CAMERA

A photographic tool designed for photo recording has been developed by the makers of the Beattie Portronic camera, *Photographic Products, Inc.*, Hollywood, California.

Varitron Model C camera has all of the features of the Portronic except the

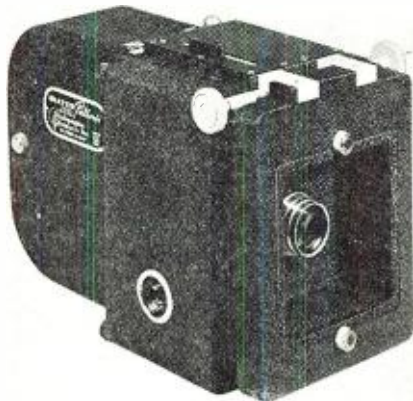

parallax-corrected, full-sized viewfinder. It is composed of three interchangeable parts and may be used in a variety of applications; such as, photo recording of meters, oscilloscopes, etc.

More complete information on the Varitron and prices are available by writing *Photographic Products, Inc.*, 955 N. Mansfield Avenue, Hollywood 38, California.

TWIN POWER SUPPLY

Model 610-F is the new electronically regulated twin power supply manufactured by *Furst Electronics*, Chicago.

Two independent and independently adjustable outputs, 0 to at least 325 volts, which may be used separately or combined, furnish the following ranges: 0-120 ma. as a single output and 0-60 ma. in each of two independent outputs.

Furst Electronics, 12 S. Jefferson St., Chicago 6, Illinois will furnish further information upon request.

H. F. WELDER

A new h.f. welder for inert gas arc welding, the first of such types to receive FCC approval, is being manufactured by the *National Cylinder Gas Company*, Chicago, Ill.

The Sureweld Gasarc welder, using a new tube-type oscillator and modified torch, prevents interference with communications by staying on its assigned frequency.

The Sureweld Gasarc welder is produced in six models, ranging from 150 to 750 amperes in capacity.



Audio Quality

(Continued from page 6)

tem (particularly in the loudspeaker), where a number of resonances and peaks in response may be present throughout the audio-frequency range. For good reproduction the system must have good transient as well as steady-state characteristics, and should have no undamped vibrations which will appear with a dynamic signal and produce undesired reverberations that distort the effect of the sound.

When sound is reproduced from disc, film or magnetic recordings the frequency of the output sound is determined by the relative speeds of the recording and reproducing drive motors. These will in general not be the same, due mainly to the difficulty of maintaining an exact slow-speed rotation reduced from the much faster motor speed. The reproducer, in particular, will generally not be running at the true speed. If there is a constant difference in speed between the two, it will however be relatively small and result only in a change in the over-all pitch of the music without destroying the relative musical values. This effect is not too objectionable, especially since different orchestras are often known intentionally to play in slightly different pitches according to the personal feelings of the conductors.

The driving motors have another drawback, however, in that they do not always run at constant speed. This results in flutter or wow in the reproduced sound and is quite annoying and serious. Its effects are apparent in the reproduction of sustained steady tones, where variations in pitch can most

easily be detected. Such speed variations can also be heard in the reproduction of percussive tones in disc recordings, where the sharp transients impose very heavy loads upon the driving motor and may cause it to change speed due to this variation in load. Under some conditions the ear can detect the presence of as little as 0.001% flutter. The best systems which are being used in broadcast and recording studios at the present time maintain constant speed to about 0.1% or better. About 1% flutter or wow is acceptable for a home reproducing system.

Analysis of the results of listener-preference tests shows that distortion in reproduction is at least as important a factor as the frequency response. Generally the listener prefers a narrow-band system with less distortion over a wider frequency range with greater noise and distortion. The loss in quality due to restricted range is less offensive to the ear than the presence of certain forms of distortion. Thus any accurate measurement of quality in an audio system should measure all the various types of distortion in order to be complete. A complete set of measurements of any type of audio system would include measurement of all the following factors:

- (a) Frequency response
- (b) Noise level
- (c) Maximum power output
- (d) Harmonic distortion at different power levels
- (e) Intermodulation distortion at different power levels
- (f) Transient response
- (g) Phase response
- (h) Wow and flutter (in disc, film or magnetic reproduction)

At the present time, methods and equipment exist for measurement of all of these quantities in all types of sound reproduction systems.

Measurement of Specific Factors Affecting Reproduction Quality

Refer again to the basic setup shown in Fig. 1. In all cases the measurement consists essentially of applying an accurately known signal to the input, and measuring the resulting output signal for the desired characteristics. The specific form which the input and output signals will take, and the specific terminal impedances and measuring equipment which must be used, will depend upon the nature of the particular system under test. The various types of input and output signals, terminal impedances, and measuring and signal generating equipment which must be used for all the different types of audio units are listed in Table I.

For each unit the type of input and output signal and the specific measure-

ments which are performed upon these signals will, of course, depend upon the distortion factor which is under consideration. The different test signals used for performing the different response and distortion measurements are shown in Table II. The information in this table represents a summary of all the measurements of quality of audio reproduction and the various factors by which it is determined. The specific methods and experimental test setups and equipment used in performing these measurements will be discussed in further detail in the following paragraphs.

Certain of the basic tests have been in general use for many years—namely, frequency response, power output, and noise level—and are so well known to engineers and technicians that they do not require any greatly detailed discussion. However, other measurements which have long been standard procedure among audio engineers (for example, measurement of harmonic distortion) are not very well known to engineers who are not audio specialists. The remaining measurements which have been described (particularly those whose importance has only recently become clearly understood) are certainly not very well known to the average electronic engineer, since they are in many cases not sufficiently understood even by many audio specialists. In fact, techniques and equipment for measuring some of these factors are at the present time still in the development

stage. However, wider knowledge and recognition of the methods of measuring and evaluating the various distortion factors will be of considerable importance in helping to improve the general over-all level of quality in all types of audio reproducing systems.

(a) *Frequency response, power output, noise level.* Frequency response is measured by applying an input signal of known amplitude and measuring the output amplitude at different frequencies in order to determine the output-input ratio throughout the frequency range that is of interest. Maximum power output is measured by increasing the input (at full gain), and observing the output signal (either aurally, or by means of an oscilloscope or a meter) to determine the output power level at which the system overloads or becomes excessively distorted. The noise level is measured by measuring the output signal with zero input signal. Measurements of these three types are common in other branches of electronics besides audio reproduction, and are well known to all electronic engineers and technicians.

(b) *Harmonic distortion.* Harmonic distortion has long been known to be a measure of amplitude non-linearity. The general method of measuring the total harmonic distortion introduced by the reproducing system is shown in Fig. 3. It consists essentially of applying to the input a steady single-frequency pure sine wave (known to be relatively

free of distortion), and measuring the harmonic content of the output signal.

Total harmonic content is measured by filtering out the fundamental component and measuring the remaining signal as a percentage of the total. The fundamental may be filtered out either by a high-pass filter (which greatly attenuates the fundamental but passes all its harmonics), or by a single-frequency rejection filter (such as the *RC* parallel-*T* type) tuned to it. The high-pass filter has the advantage of eliminating the effects of a.c. hum and other low-frequency noise, but the rejection filter is generally easier and more convenient to use.

The magnitude of the individual harmonic components may be measured with the wave analyzer, as indicated in Fig. 2. The wave analyzer contains an accurately calibrated variable tuned circuit so that it measures only one harmonic component at a time. Such a measurement is capable of giving information concerning the order as well as the amount of harmonics, and therefore can also be used for estimating the amount of intermodulation distortion which may be expected from the system.

When either of these two methods is used, the general procedure is first to measure the total signal (including the fundamental) with the vacuum-tube voltmeter, then switch the signal through the filter and measure the amplitude passed by the filter. This, then, gives the harmonic amplitude as a percentage of the fundamental.

(c) *Intermodulation distortion.* The measurement of intermodulation distortion is a relatively new technique in audio measurements. Intermodulation is caused by the same amplitude non-linearity which causes harmonic distortion, but neither one can be readily calculated from the other.

The intermodulation characteristics of a system are measured by applying two known frequencies simultaneously to the input, and determining the degree of interaction and distortion of these two frequencies by measuring the magnitude of the new frequencies generated in the system. The block diagram of a basic setup for performing this type of measurement is shown in Fig. 4. Two units are required: a signal generator which supplies the composite input signal, and the analyzer which determines the amount of cross modulation generated in the reproducing system.

For the purposes of determining intermodulation, the composite signal effectively simulates those characteristics of a normal audio signal that are important in generating the intermodulation products which unpleasantly affect quality of the reproduction. It consists of a low-frequency component between 40 and 150 cycles per second,

Table II—Test signals used for performing the various response and distortion tests, and acceptable limits for these distortions.

Response or distortion being measured	Input signal	Output signal	Acceptable limits	
			Good reproduction	Acceptable reproduction
Frequency response	Steady sine wave	Steady sine wave	20-14,000 c.p.s.	40-10,000 c.p.s.
Power output	Steady sine wave	Steady sine wave	Depends upon size of listening room.	
Noise level	Zero	Random noise	-60 db. (below full output)	-50 db. (below full output)
Harmonic distortion	Steady sine wave	Fundamental plus harmonics	2% Total harmonics	2-5% Total harmonics
Intermodulation distortion	Sum of high-frequency and low-frequency steady sine waves	Amplitude-modulated sine wave	5%	10%
Transient response	Step voltage or Tone burst	Step voltage or Tone burst	No set standards	
Phase response	Steady sine wave	Steady sine wave	No set standards	
Wow and Flutter	Steady sine wave	Frequency-modulated sine wave	0.1%	1.0%

and a high-frequency component which may be either about 2000 cycles or between 7000 and 12,000 cycles per second. The amplitude of the low-frequency is about four times as great as (i.e., 12 db. higher than) the high-frequency component. These two signals are generated separately, and combined in a mixing and attenuator circuit in such a manner that there is no appreciable interaction or intermodulation between them. By means of the attenuator, the composite signal can be applied at any desired level to the system under test. This choice of low and high frequencies, and of their relative amplitude of four-to-one, gives a fairly accurate representation of the sounds which are most importantly affected by intermodulation distortion.

The extent to which the reproduction system reproduces between the two components is a measure of the amount of intermodulation that will be introduced into the more complex sounds of speech and music. The amount of intermodulation which the system introduces into the composite signal is measured by the analyzer unit. This distortion consists of amplitude modulation of the high-frequency component at the low-frequency rate (or at some multiple of it). It is not necessarily sinusoidal, but has a wave shape which depends upon the transfer characteristic of the system under test. The fundamental basis of intermodulation distortion measurements is to measure the amount of this amplitude modulation as a function of the amplitudes of the two input frequencies. The percentage of intermodulation is generally defined as:

$\% \text{ Intermodulation} = \% \text{ Amplitude modulation of the high-frequency signal for the composite signal as described above.}$

The measurement is accomplished by passing the reproduced signal through suitable filters to separate the desired frequency components, and measuring their relative levels. The low-frequency component is removed first by a band-pass or a high-pass filter which passes only the high-frequency signal and whatever modulation products may be present. The high-frequency signal is then demodulated and passed through a low-pass filter to determine the amount of low-frequency modulation present in the reproduced high-frequency component. The relative amplitudes are meas-

ured by vacuum-tube voltmeters as shown in the block diagram.

In certain audio applications (and particularly in the design of new equipment), it is often desirable also to have a distortion phase detector for measuring the relative phase of the intermodulation. This would indicate whether the intermodulation occurs on the positive or negative swing of the low-frequency signal, or whether it is symmetrical. However, this measurement need not be performed when the primary purpose of the test is to determine the quality of the reproduction.

A number of commercial units are available at the present time which incorporate these various features for intermodulation measurements. Photographs of one of these units, which contains a phase detector as well as the signal generator and analyzer units, are shown on pages 3 and 5.

(To be continued)

Decade Counter

(Continued from page 10)

tional current flows through common plate resistor R_2 causing anode voltage drop but the capacitor tends to hold the cathode at the +37 volt value. This makes tube B extinguish itself since its anode voltage drops below the critical value long enough to stop conduction and permit its grid to regain control.

The count has now advanced from tube to tube so that number 9 is conducting and sets up the bias or primes both the number 0 tube and the transfer tube as shown in Fig. 3. When the next or 10th pulse comes along, number 0 and transfer tube will conduct simultaneously but the transfer tube will conduct for only a few microseconds before extinguishing because $R_2 + R_3$ value is high. In this manner a pulse is sent through the output to the next decade unit.

To start the counter or set it to zero the equipment is turned on and B plus voltage is applied, but before any pulses are applied the voltage is removed momentarily from the line marked 2. This fires number 0 tube after reducing its bias to zero.

Pulse values range between 15 and 25 volts and pulse-time can be relatively slow compared with those of many other modern counters. The counter will operate on a pulse with a rate of change as low as 3 volts per microsecond or about equal to the rate of rise of a 60 cycle, 5600 volt sine wave as it crosses the 0 axis. It will count pulses at a random rate or in a continuous train at rates from 0 to 5000 per second and will hold the count indefinitely or until power is turned off.

Fig. 4 shows the mechanical design of the counter permitting placement of all components in a can only 2" in diameter and 2½" in height. Each tube and

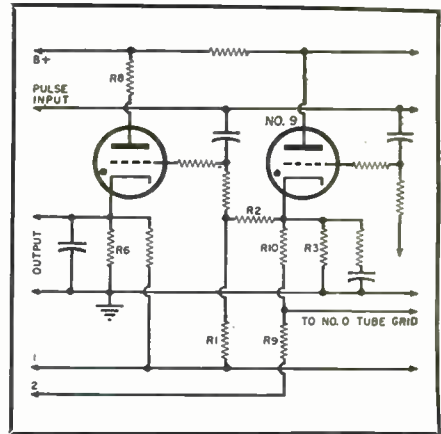

Fig. 3. Circuit of the final stages of the counter.

its group of components is mounted on a ceramic card to permit printed wiring. The "printed" capacitors are made from a piece of ceramic dielectric having both sides silvered. The Global ½ watt resistors are compact, stable and provide tolerance values of 10%.

One of the problems of compact design concerned the application of capacitors using Hi-K, high dielectric material, in which dielectric constant varies widely with temperature. Some idea of the problem may be gained by our research which showed one material provided a nearly constant dielectric value up to 60° C. but dropped off sharply to one third of the value at 100° C. Using another material constant capacity was maintained up to 80° C., increased 20% at 100° C. and over 400% at 120° C.

Fig. 1 shows the complete subminiature decade counter unit including perforated can to facilitate air cooling for about 10 watts of heater power.



Fig. 4. Mechanical design of the individual counter stages.

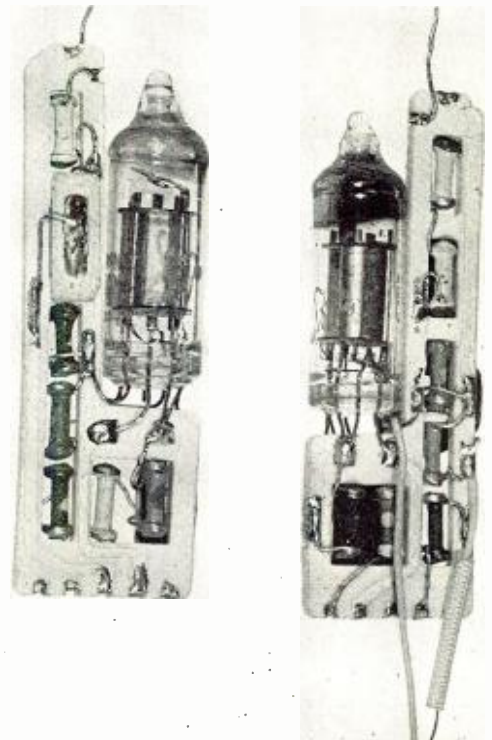

PHOTO CREDITS

Pages

3, 5. Western Electric Co.
10, 31. . . . Sylvania Elec. Prod., Inc.
11, 20. . . . Nat. Bureau of Standards
16, 17. Polytechnic Inst. of Brooklyn

**A MUST Book for
Everyone Interested in**

TWO-WAY RADIO

By
SAMUEL FREEDMAN
Commander S(E)T, USNR

506 Pages of Facts!

MECHANICS—EQUIPMENT—APPLICATIONS
with studies of actual installations

No radio man's technical library can be without this complete text on two-way radio. TWO-WAY RADIO covers the mechanics and applications of two-way radio for all forms of fixed, mobile and portable communication. It is written in non-mathematical form and in language easily understandable by users or intended users of this type of equipment. An excellent guide for servicemen and radio amateurs, as well as engineers, executives, and planners who are interested in a detailed analysis of the applications and equipment in this field.

Answers all questions

TWO-WAY RADIO gives concrete answers to your practical questions: How is it used? What are the potentialities of two-way communication? Is it efficient? Is it economical? What types are best suited for specific uses? What are the technical requirements? What are the licensing regulations? Here, in accurate, complete, and useable form is the data you need for these and a host of other pertinent questions—the basic technical information which will enable you to keep pace with the fast-coming developments in two-way radio communication.

Graphically illustrated

Included in TWO-WAY RADIO are 87 informative illustrations—charts, diagrams, and photographs of equipment and installations, carefully chosen by the author to illustrate his twenty chapters of text material.

The opening chapters are devoted to planning of two-way radio and details of equipment, power supply, mobile and fixed stations, and proper antenna systems. Then follows a detailed analysis of AM and FM equipment, radio and guided carrier systems, and a full discussion of microwaves. Latter chapters describe two-way radio communication as used by railroads and police, fire, highway and forestry services; also marine and aeronautical applications, and personal use by radio amateurs and private citizens. There is ample information on maintenance, repair, and trouble shooting, a full chapter on licenses and regulations, and a description of typical installations by states, communities and border patrol.

**Price \$5.00. Use convenient coupon
with full return privileges**

ZIFF-DAVIS PUBLISHING COMPANY
185 North Wabash Avenue, Chicago 1, Ill.

**Fully Illustrated!
Charts, Diagrams!
Photographs!**

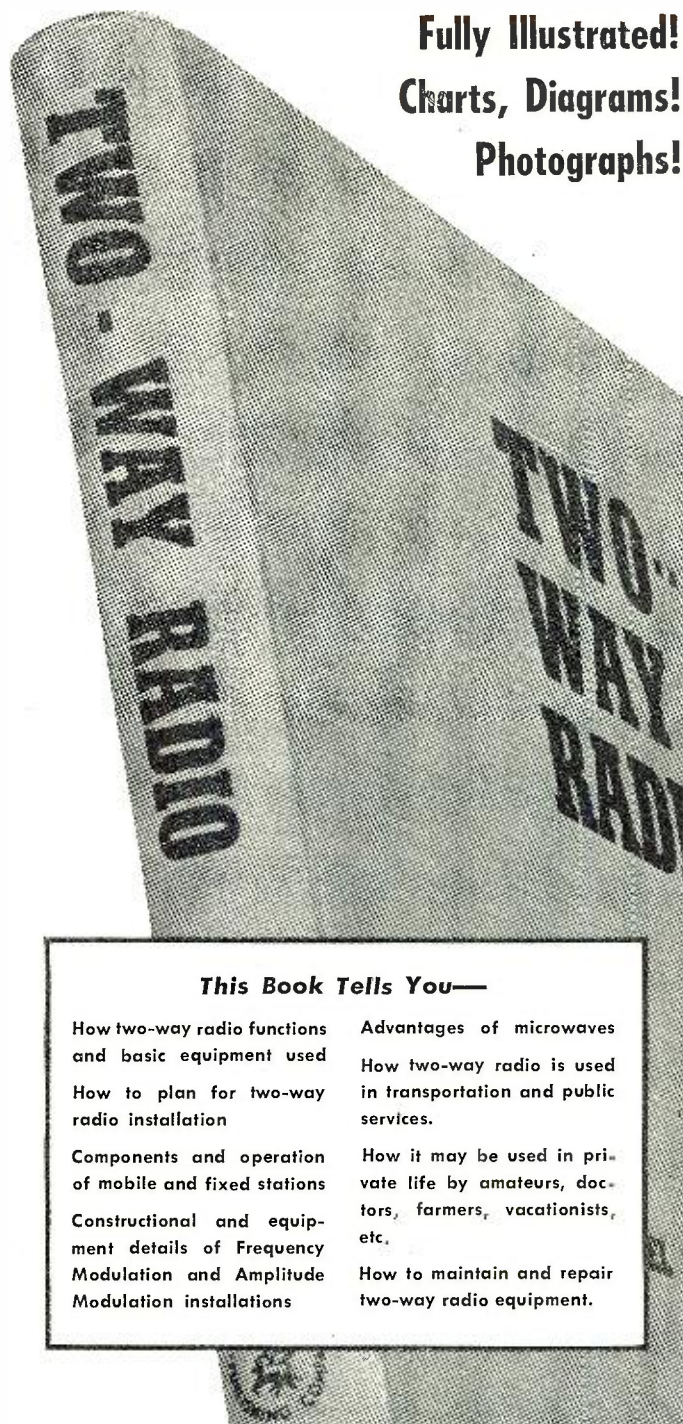

This Book Tells You—

- | | |
|---|--|
| How two-way radio functions and basic equipment used | Advantages of microwaves |
| How to plan for two-way radio installation | How two-way radio is used in transportation and public services. |
| Components and operation of mobile and fixed stations | How it may be used in private life by amateurs, doctors, farmers, vacationists, etc. |
| Constructional and equipment details of Frequency Modulation and Amplitude Modulation installations | How to maintain and repair two-way radio equipment. |

MAIL THIS COUPON TODAY

ZIFF-DAVIS PUBLISHING COMPANY
185 North Wabash Ave., Chicago 1, Illinois

I am enclosing \$5.00 (check or money order) for which please send me one copy of TWO-WAY RADIO. I understand that I may return book within five days for full refund if I am not entirely pleased.

Name.....

Address.....

City.....Zone.....

State.....

REE 7-49

presenting

the

TV-10W

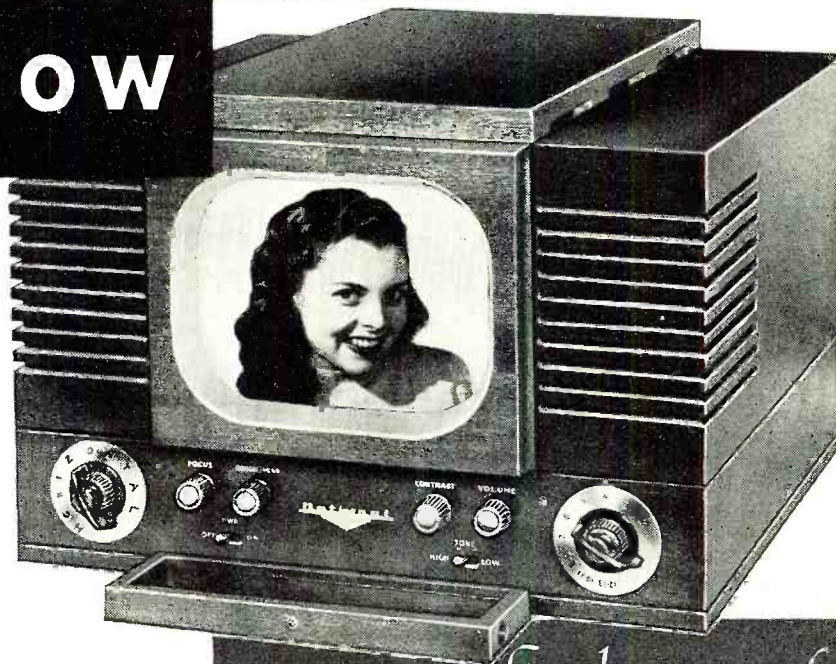

newest and handsomest of all

Latest flyback high voltage supply gives clear, bright pictures even in fringe areas ● Automatic frequency control locks picture in place ● Two flanking speakers do justice to FM sound ● Front-of-panel focus control ● Coil switching assures equivalent of separate, high-Q tuned circuits for each channel ● Automatic gain control ● 3-stage 37 mc IF minimizes picture interference caused by other radio services ● Double-tuned RF bandpass circuits improve selectivity and image ratio. ● Automatic Station Selector and fine tuning control.

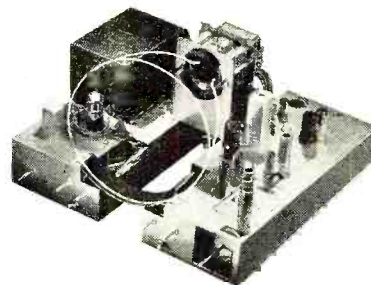

Features a big 10-inch picture tube — most popular size of all — in a genuine mahogany cabinet handsomely styled in the spirit of tomorrow . . . yet only

\$269⁵⁰

SLIGHTLY HIGHER WEST OF THE ROCKIES



Choose
PYRAMID
 ELECTROLYTICS
 for
 Top performance
 at 85°c



Pyramid Type 85TM Capacitors are now in volume production for leading TV-receiver manufacturers throughout the U.S.A. and Canada.



PYRAMID
 CAPACITORS

PYRAMID ELECTRIC COMPANY
 155 Oxford Street
 Paterson, N. J., U.S.A.
 TELEGRAMS: WUX Paterson, N. J.
 CABLE ADDRESS: Pyramidusa

Within the
INDUSTRY

HUGH WAINWRIGHT, formerly mechanical engineering specialist working with the production of electronic, radar, and radiation survey instruments, has been appointed the sales engineer for the Electronics Division of *Sylvania Electric Products, Inc.*



Before joining the *Sylvania* engineering staff early in 1946, Mr. Wainwright served with the Navy, and prior to that time, he was associated with E. B. Badger, where he specialized in designing equipment for the petroleum, synthetic rubber, and chemical industries.

Mr. Wainwright is a native of Boston and attended the Massachusetts Institute of Technology. He is a member of the American Society of Metals.

H. A. BREWER, as new northwestern district manager for the *Westinghouse Home Radio Division*, will make his headquarters in Chicago. . . . Appointment of **ANGELO DIDONATO** as factory superintendent and assistant to the works manager of the *Andrea Radio Corp.* has recently been announced. . . . **REX D'AGOSTINO**, formerly of the *Lafayette Radio Store* in Newark, New Jersey, is the new national merchandise manager for the company, and in his new post will serve all seven stores located in New York City, the Bronx, Newark, Boston, Chicago, and Atlanta. . . . **DONALD B. SMITH** will direct the *Lewyt Corporation* advertising, sales promotion, and public relations in his new post of sales promotion manager. . . . New chief purchasing agent of *Littelfuse, Inc.*, is **DAVE SCHAIBLE**, whose duties will include the procurement of everything used in the plant from packaging to glass, brass, and zinc elements. . . . *Transvision, Inc.*, New Rochelle, N. Y., has announced the appointment of **J. J. SAUNDERS** as director of purchasing for the firm.

EDWARD F. KONCEL, a graduate student at Illinois Institute of Technology, was awarded the Charles LeGeyt Fortescue fellowship in electrical engineering by the American Institute of Electrical Engineers. The \$1500 award covers two semesters of study in power system engineering.

Koncel, who was prominent in extracurricular activities while an undergraduate, received his bachelor's degree at the Institute's February commencement.

The fellowship, which is awarded by the AIEE to the candidate selected

from groups of applicants in engineering colleges throughout the nation, was established to honor the memory of Dr. Fortescue, inventor and engineering pioneer, who died in 1936.

FREED TRANSFORMER CO., INC., has announced that its new address is 1718-36 Weirfield St., Ridgewood, Brooklyn 27, N. Y. . . . The firm of **COZZENS & FARMER**, Raytheon broadcast equipment representative for the Mid-West, is now located at 720 Main St., Evanston, Ill. . . . The entire Chicago service department of the **ADMIRAL CORPORATION** has been moved to 201 East North Water St., Chicago 11, Ill. . . . **ALMO RADIO COMPANY** of Philadelphia has opened a new branch store at 6205 Market St., which will provide key service to customers located in West Philadelphia and the Main Line suburbs. . . . **CON-RAC, INC.**, manufacturer and distributor of electronic equipment, has purchased the *Peyton Television Company*, Glendora, California. It is planned to retain and expand Peyton personnel and plant facilities. . . . A new **RAYTHEON MANUFACTURING CO.** radio tube warehouse has been established at 1133 Ponce de Leon Ave., N.E., Atlanta, Ga., for the purpose of assuring prompt service to customers in the southeastern area.

LEONARD G. RICH is the newly appointed assistant chief engineer for the *McMurdo Silver Co., Inc.*, and will assist Douglas H. Carpenter, chief engineer, in the design of the company's new test equipment.



Mr. Rich was formerly associated with *Crystal Research Laboratories*, where he completed various governmental projects. He is a graduate of St. Lawrence University, having received a B.S. degree in physics. In addition, he completed graduate work in advanced electronic physics and electronic engineering at Cornell University.

R. M. KARET & ASSOCIATES has been appointed to represent the *Universal Toy & Novelty Co.* line of table-top television tables in all of the 48 states, excluding California, Nevada, and Arizona, as well as national representatives for the *Signet Development Co.* Flame-Pruf loudspeakers. . . . **MILTON BENJAMIN** and **HENRY GOLD-SMITH** are new factory sales representatives for the *Garod Electronics Corporation* line of "Tele-Zoom" TV

RADIO & TELEVISION NEWS

NO CHARGE! . . . with initial \$50 order of OLIN Radio Batteries



SUGGESTED \$50.³⁸ ORDER

- 12 #1710 "B" Batteries
- 6 #6210 "B" Batteries
- 6 #4918 "A" Batteries
- 2 #0614 "A-B" Packs
- 2 #0615 "A-B" Packs

IDEAL COMBINATION WINDOW AND FLOOR DISPLAY No. 640

- Will hold at least 200 lbs. of radio batteries
- Needs only 14x20 inches floor space...40" high
- Full-color, attractive design
- Lower shelf can display portable radio as "TODAY'S SPECIAL"

This combination full-color display available for immediate shipment: (Shown here in two colors only).

GET SET FOR SUMMER SELLING — order complete line Olin radio batteries and combination display from your Wholesaler's Salesman TODAY.

Easy on the Ears...

TELEX MONOSET*—Under Chin Headset

Stethoscope design of the Telex *Monoset* eliminates tiresome pressure—instrument swings lightly *under* the chin. Wear it for hours without fatigue!

Telex *Monoset* sends signal directly into both ears, blocking out background noise. Built of durable Tenite, the *Monoset* is excellent for communications, office dictation equipment, aircraft radio, wired sound installations, dental offices and beauty shops. Choice of five-foot cords: standard, or with built-in volume control.



TELEX TWINSET*—Nothing Need Touch Ears!

Here's the lightest twin-receiver headset made—Telex *Twinset* weighs only 1.6 oz! In-phase receivers assure excellent sensitivity and full-range high fidelity, non-resonating sound reproduction... eliminate listening fatigue. Adjustable, self-locking sound arm may fit into the ear, or may be moved a fraction of an inch away, so that *nothing* touches the ear.

Telex *Twinset* adjusts simply to any shape head, without pinching or pressure. So flexible it may be coiled up and slipped into the pocket! Perfect for any headset need—amateur, experimental, commercial. Special cord with built-in volume control available.



TELEX Earset*—Slips onto the Ear

Unlimited earphone applications are possible with the new Telex *Earset*. Weighing only 1/2 oz., this entirely new conception in earphone design finds a ready welcome among stenographers, technicians—all who use single-phone headsets.

Earset's flat plastic frame slips onto the ear, holds the sensitive receiver securely in place. User's other ear is always free for phone calls or conversation. Telex *Earset* won't fall or slide off—fits either right or left ear, may be worn by anyone without special adaptation.



TELEX PILLOW SPEAKER— For private radio listening

Solves the problem of radio listening without disturbing others—in hospitals, hotels, trains, buses, institutions. Telex Pillow Speaker tucks away beneath pillow, headrest or cushion—makes possible perfect individual reception!

Palm-sized, weighs only 1.1 ounces, yet virtually unbreakable. Easily sterilized in alcohol. Entire assembly completely shock-proof. Detachable flexible cord.

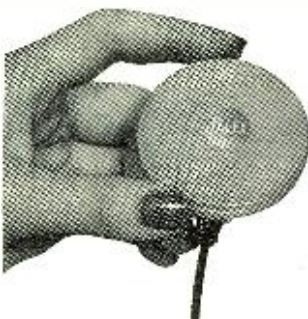

*Trademark

For further information write

TELEX

DEPT. H-14-7 • TELEX PARK
MINNEAPOLIS 1, MINNESOTA
In Canada, Atlas Radio Corp., Toronto

STANDARD OF THE WORLD FOR QUALITY HEADSETS

receivers and allied radio products, for the New England and Mid-West areas respectively. . . . **JOHNNY PARSONS** has been named sales promotion manager of the *Hoffman Radio Corporation* in Los Angeles, while Don Larson will continue to serve as advertising manager. . . . **HARRY ESTERSOHN** will be the sales manager of the *Jerrold Electronics Corporation*, manufacturer of television accessories, with offices at 121 N. Broad St., Philadelphia, Pa. . . . **JACK STEINMAN**, **GABE ASHLEY**, and **FRED SATLOFF**, are three new additions to the sales force of *Motorola, Inc.*, in New York. . . . **SAM BIALEK** and **LEON ADELMAN** will cover the greater metropolitan New York area for the *Permoflux Corporation*, manufacturer of a complete line of speakers. . . . **FRANK W. GUTHRIE** has been assigned the position of sales manager of *The Rawland Corporation*, manufacturer of "Visi-tron" aluminized television picture tubes. . . . **JOHN P. VAIL** will act as distributor sales representative for the radio division of *Sylvania Electric Products, Inc.*, in the districts of Pennsylvania, Ohio, Michigan, West Virginia, and Maryland.

* * *

ROGER M. WISE, electron tube expert active in tube research and development for *Philco Corporation*, has been awarded the Certificate of Merit by the President of the United States, in recognition of his outstanding war work.

The citation refers to Mr. Wise's accomplishments in connection with the engineering and production aspects of subminiature tubes for proximity fuses. *Philco* was a leading manufacturer of these VT proximity fuses, which were credited with saving London from the V-1 rockets or buzz-bombers.

Mr. Wise and his staff of tube engineers recently joined the *Philco* organization to aid in the company's extensive program of research in television, radio, and industrial electronics.

* * *

ELLERY W. STONE was elected president at a meeting of directors of the *Capehart-Farnsworth Corporation*, newly-formed and wholly-owned subsidiary of the *International Telephone and Telegraph Corporation*.

Admiral Stone, vice-president of *IT&T* is also president of *Federal Telephone and Radio Corporation* and *International Standard Electric Corporation*. He has served since 1931 in various executive capacities with the *IT&T* system. A native of Oakland, California, he specialized in radio engineering at the University of California.

The election of David R. Hull as executive vice-president was also announced, and Edwin A. Nicholas will act as assistant to the president.

Also elected were Philo T. Farnsworth, vice-president; Henry C. Roemer, vice-president; William Clausen, (Continued on page 113)

RADIO & TELEVISION NEWS

Which Job for YOU next year?

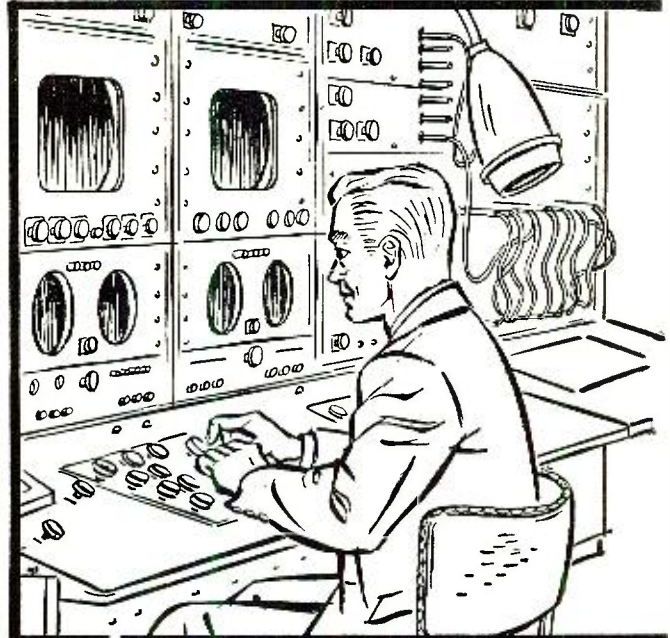
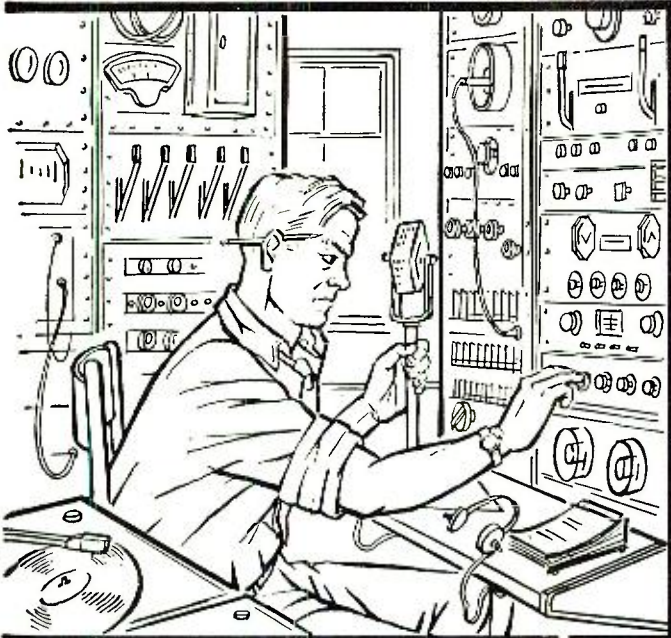

NO VISION

OR

TELEVISION

Get on the TV Band-Wagon Now!

Don't let the lack of vision keep you behind the progress parade. Be alert to the opportunities—the good paying jobs—the secure future that Television offers!

Prepare NOW for the interesting and profitable jobs awaiting trained television engineers and technicians. CREI offers you a proved program of on-the-job training that can provide you with the technical ability to step ahead of competition and get a good-paying Television position.

Sooner or later you *must* face Television—as a *problem*, or as an *opportunity!* You can make your own opportunity by preparing yourself *now*. CREI can show you the way with convenient spare-time study that gives you the up-to-the-minute technical ability you must have for Television!

CREI courses are designed to give you a thorough grounding in basic principles and take you

VETERANS: CREI TRAINING AVAILABLE UNDER G.I. BILL. FOR MOST VETERANS JULY 25, 1951, IS THE DEADLINE — ACT NOW!

If you have had professional or amateur radio experience and want to make more money, let us prove to you we have the training you need to qualify for a better radio job. To help us answer intelligently your inquiry—*please state briefly your background of experience, education and present position.*



Capitol Radio Engineering Institute

An Accredited Technical Institute Founded in 1927

Dept. 117A, 16th and Park Road, N. W., Washington 10, D. C.

Branch Offices: New York (7) 170 Broadway • San Francisco (2) 760 Market St.

step-by-step through the more advanced subjects of TV and its related fields. Because all *new* electronic developments are based on *past* techniques, your own radio experience becomes doubly important when coupled with modern CREI training. You will find the CREI study program basic and helpful right from the very start. You will learn about and understand such subjects as: Optics, Pulse Techniques, Deflection Circuits, RF, IF, AF and Video Amplifiers; FM; Receiving Antennas; Power Supplies; Cathode Ray; Iconoscope; Image Orthicon and Projection Tubes; UHF Techniques, Television Test Equipment, etc.

Get in and *get ahead* in Television. One industry leader predicts *12 Million* TV sets by 1953. This means hundreds of stations, millions of listeners and countless opportunities for the right men to fill the good positions in every phase of the industry. The facts are available to you *now*. Mail the coupon for complete details. The cost is *popular*. The terms are *easy*. The information is *free*. Write today.

MAIL COUPON FOR FREE BOOKLET

CAPITOL RADIO ENGINEERING INSTITUTE

16th & Park Road, N. W., Dept. 117A, Washington 10, D. C.

Gentlemen: Please send your free booklet, "Your Future in the New World of Electronics," together with full details of your home-study training. I am attaching a brief resume of my experience, education and present position.

Check field of greatest interest:

- | | |
|---|---|
| <input type="checkbox"/> PRACTICAL RADIO ENGINEERING | <input type="checkbox"/> PRACTICAL TELEVISION ENGINEERING |
| <input type="checkbox"/> AERONAUTICAL RADIO ENGINEERING | <input type="checkbox"/> TELEVISION, FM & ADVANCED AM SERVICING |
| <input type="checkbox"/> BROADCAST RADIO ENGINEERING (AM, FM, TV) | <input type="checkbox"/> ADVANCED ELECTRONICS COMMUNICATIONS |
| | <input type="checkbox"/> RADIO-ELECTRONICS IN INDUSTRY |

NAME.....

STREET.....

CITY.....ZONE.....STATE.....

I AM ENTITLED TO TRAINING UNDER G. I. BILL.

Build profits 3 ways

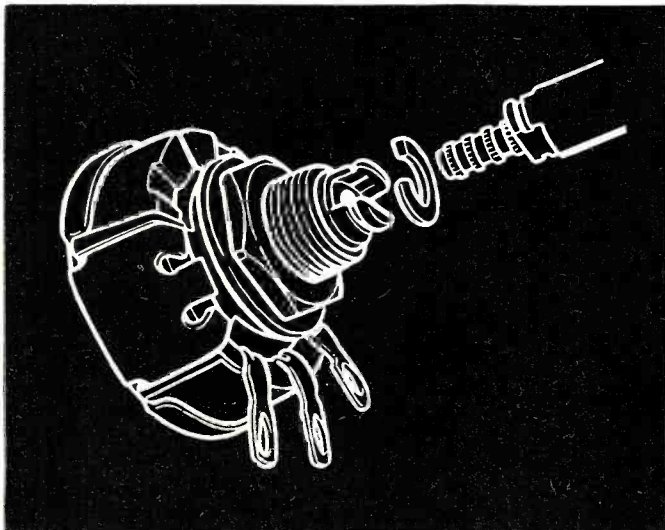

Controls: With CRL's improved *Adashaft* Radiohms you can carry a small stock of controls, yet be ready to handle almost any kind of control replacement problem. No wiggle, no wobble, no slip. Just insert shaft pilot in control stub shaft, and slip "C" washer into place. Available in all sizes for all model "M" volume control applications. Six types of shafts.

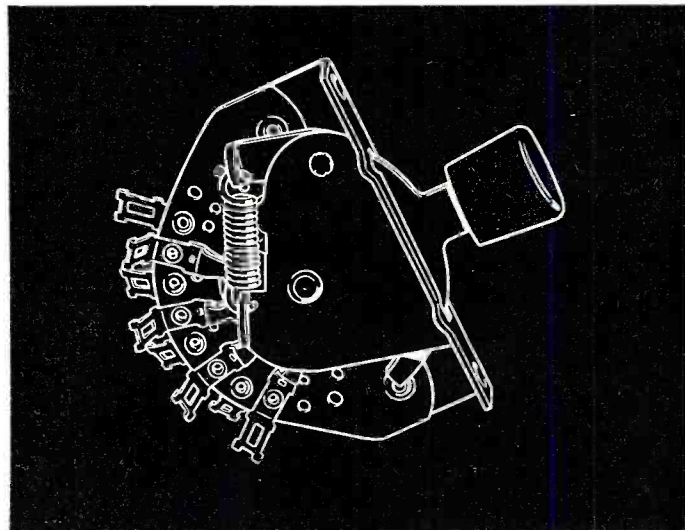

Switches: Centralab offers you a complete line of Tone, Rotary Selector, Lever Action and Medium Duty Power Switches, which features a wide variety in both laminated phenolic and steatite insulation. Available with shorting or non-shorting contacts. See your Centralab Distributor for further information, or write direct for new Catalog 26.

with Centralab parts

Three real advantages are yours when you use dependable CRL replacement parts in your shop. That's the word of successful servicemen everywhere. These men report — 1. Centralab parts are easy to stock . . . easy to identify. Many CRL components are packaged to give you more shelf space . . . neater displays. All are clearly labeled for quick identification. 2. Centralab parts are easy to use. CRL design speeds repairs by eliminating tricky bending or fitting operations. 3. Centralab parts provide performance that insures repeat orders . . . invites new customers. Yes — Centralab parts can help you build up your service business. Get the complete story from your CRL distributor.

— Phil A. Smith, owner of the Smith Radio & Appliance Company, Shorewood, Wisconsin, says, "I've been in the radio-servicing business 21 years — using Centralab replacement parts from the beginning. During this period I've had plenty of opportunity to prove just how dependable CRL parts are."

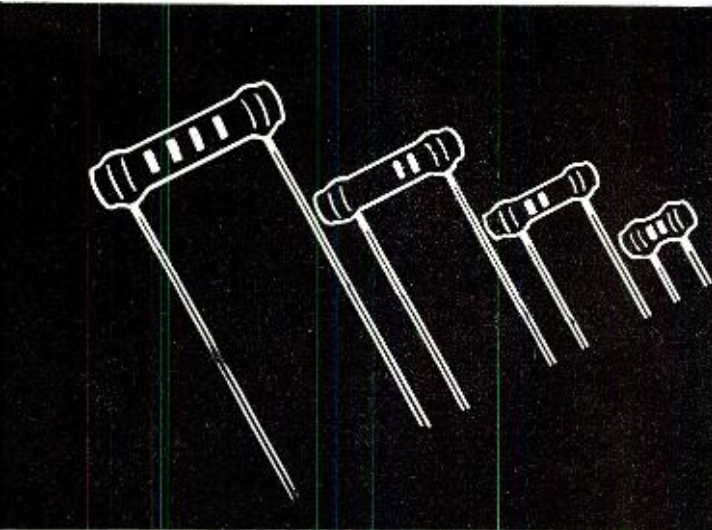

"Hi-Kaps": CRL line of ceramic By-pass and Coupling Capacitors gives you ceramic dependability and permanence at a new low price! Packaged in a convenient envelope of five, *Hi-Kaps* are clean, easy to stock and handle. Wide range from .000050 to .010000 mfd. Rating — 600 WVDC, 1000 VDC. flash tested. Ask your Centralab Distributor for all the facts.

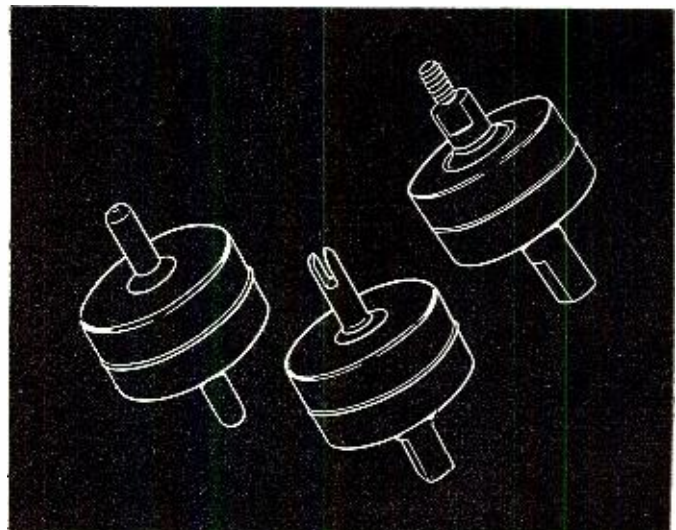

"Hi-Vo-Kaps": Just out! Centralab's new high voltage capacitors for television and high voltage applications. Made of Ceramic-X, *Hi-Vo-Kaps* combine high voltage and small size to give you convenient, dependable performance. 10,000 WVDC, flash tested, 20,000 VDC. Capacity — 500 mmf. See your CRL Distributor, or write direct.

HERE'S PACKAGED POWER ON TAP!

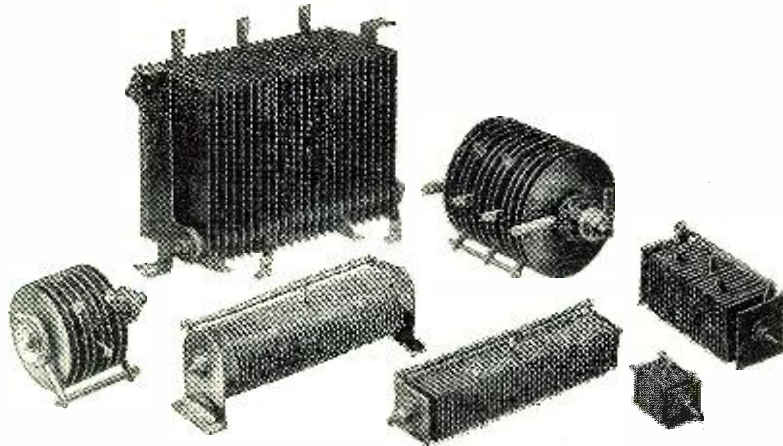

Your Check-List of FEDERAL'S Selenium Rectifier Stacks . . .

SELECT THE TYPE YOU NEED . . .
Get immediate delivery from Dealer or Distributor

Now you can engineer your own AC to DC power conversion. Just check your requirements against Federal's list of Packaged Power and order what you need. Dealers and distributors stock these popular standard sizes, and can fill your order promptly and accurately.

This list includes but a fraction of Federal Stacks—many more types have been developed for special applications. Our engineers always stand ready to cooperate in the design of any new stack you may require. Send for handy "Packaged Power" check list. Write Department F-543.

Federal, America's oldest and largest manufacturer of Selenium Rectifiers, also has a complete line of Miniature Selenium Rectifiers, ranging in size from 65 Ma. to 500 Ma.

D.C. OUTPUT VOLTS	RECTIFIER STACK CODE NUMBER	APPROX. A.C. INPUT VOLTS		CIRCUIT AND STACK CONN. DIAGRAM	RECTIFIER STACK DIMENSIONS			CATALOG NUMBER
		NEW	MAX.		A	B = 1/16"	FIG.	
6	6C1ABX1	8	9	'B'	3 3/8"	1 1/16"	1	2001
	7C1ABX1	8.2	9		4 3/8"	1 1/16"	1	2002
	233C1ABX1	8.5	11		4 3/8"	1 3/8"	1	2003
	28C1ALX1	8.2	9		6 5/8" x 4 1/2"	1 1/2"	2	2004
	234C1ALX1	8.5	11		6 5/8" x 4 1/2"	1 15/16"	2	2005
6	6B1ABX1	9	18	'A'	3 3/8"	2 1/16"	1	2006
	7B1ABX1	9.4	18		4 3/8"	2 1/16"	1	2007
	33B1ABX1	10	18		4 3/8"	2 11/16"	1	2008
	28B1ALX1	9.4	18		6 5/8" x 4 1/2"	2 1/16"	2	2009
	34B1ALX1	10	18		6 5/8" x 4 1/2"	2 1/16"	2	2010
12	6B1ABX1	16	18	'A'	3 3/8"	2 1/16"	1	2011
	7B1ABX1	16.3	18		4 3/8"	2 1/16"	1	2012
	233B1ABX1	16.8	22		4 3/8"	2 11/16"	1	2013
	28B1ALX1	16.3	18		6 5/8" x 4 1/2"	2 1/16"	2	2014
	234B1ALX1	16.8	22		6 5/8" x 4 1/2"	2 1/16"	2	2015
24	6B2ALX1	32	36	'A'	3 3/8"	3 3/16"	3	2016
	7B2ALX1	32.6	36		4 3/8"	3 3/16"	3	2017
	233B2ALX1	33.6	44		4 3/8"	5"	3	2018
	28B2ALX1	32.6	36		6 5/8" x 4 1/2"	3 3/8"	4	2019
	234B2ALX1	33.6	44		6 5/8" x 4 1/2"	5"	4	2020
32	206B2ALX1	41	44	'A'	3 3/8"	3 3/16"	3	2021
	207B2ALX1	41.5	44		4 3/8"	3 3/16"	3	2022
	133B2ALX1	42.5	52		4 3/8"	5"	3	2023
	228B2ALX1	41.5	44		6 5/8" x 4 1/2"	3 3/8"	4	2024
	134B2ALX1	42.5	52		6 5/8" x 4 1/2"	5"	4	2025
36	106B2ALX1	45	52	'A'	3 3/8"	3 3/16"	3	2026
	107B2ALX1	45.5	52		4 3/8"	3 3/16"	3	2027
	133B2ALX1	46.7	52		4 3/8"	5"	3	2028
	128B2ALX1	45.5	52		6 5/8" x 4 1/2"	3 3/8"	4	2029
	134B2ALX1	46.7	52		6 5/8" x 4 1/2"	5"	4	2030
48	206B3ALX1	61.5	66	'A'	3 3/8"	4 1/2"	3	2031
	207B3ALX1	62	66		4 3/8"	4 1/2"	3	2032
	133B3ALX1	63.5	78		4 3/8"	6 3/4"	3	2033
	228B3ALX1	62	66		6 5/8" x 4 1/2"	4 13/16"	4	2034
	134B3ALX1	63.5	78		6 5/8" x 4 1/2"	7 1/16"	4	2035
120	104B6SALX1	148	156	'A'	1 17/32" sq.	4 1/8"	5	2036
	105B6ALX1	148	156		2 5/8"	7 5/8"	3	2037
	106B6ALX1	149	156		3 3/8"	7 5/8"	3	2038
	107B6ALX1	151	156		4 3/8"	7 5/8"	3	2039
	133B7ALX1	157	182		4 3/8"	14 1/8"	3	2040

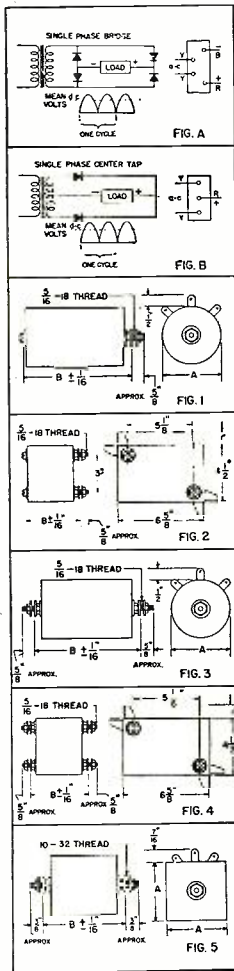

Federal Telephone and Radio Corporation

SELENIUM and INTELIN DIVISION, 900 Passaic Ave., East Newark, New Jersey

In Canada: Federal Electric Manufacturing Company, Ltd., Montreal, P. Q.
 Export Distributors: International Standard Electric Corp., 67 Broad St., N.Y.



An IT&T Associate

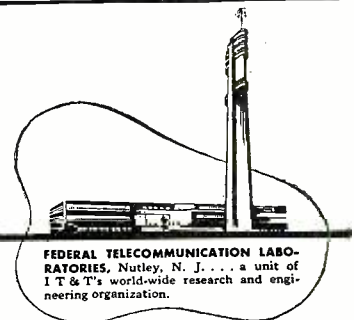

FEDERAL TELECOMMUNICATION LABORATORIES, Nutley, N. J. . . . a unit of I T & T's world-wide research and engineering organization.

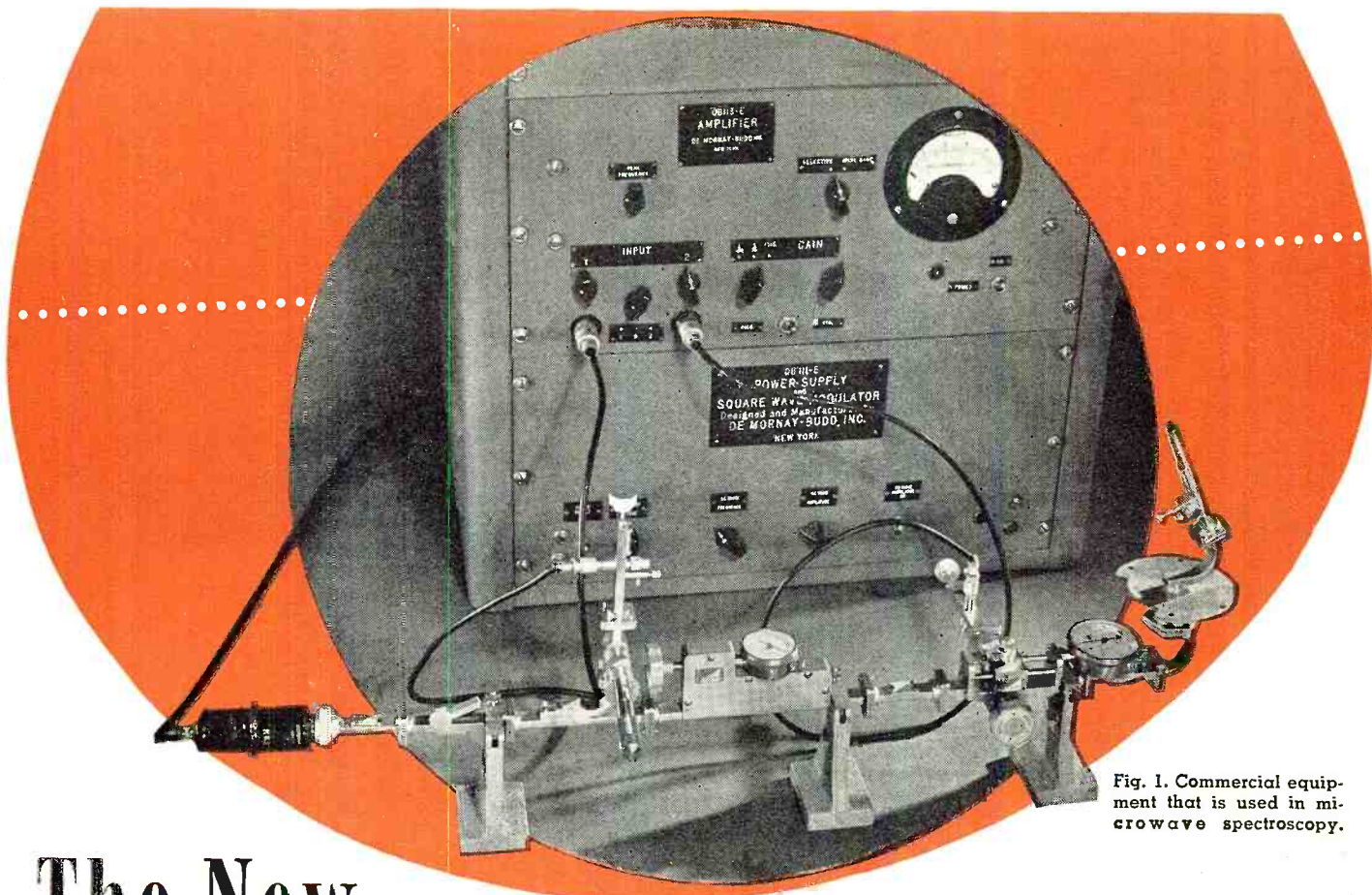

Fig. 1. Commercial equipment that is used in microwave spectroscopy.

The New Field of Microwave Spectroscopy

By **SAMUEL FREEDMAN**

New Developments Engineer,
DeMornay Budd, Inc.

Modern microwave techniques make it possible to determine the composition of gases, liquids, and solids by observing microwave absorption spectrum.

THE poor propagational characteristics of microwaves on frequencies exceeding about 20,000 megacycles (wavelengths shorter than 1.5 centimeters) have led to developments which make possible extraordinary resolution of the molecules of matter.

Microwave spectroscopy is the technique used to determine the radio frequencies in the microwave region (normally exceeding 20,000 megacycles) which cannot readily or even at all pass through gases, liquids, or solids. Such frequency is measured and is a direct indication as to the identification of the specific molecule of matter contained in such gas, liquid or solid.

Every element of matter can disturb the passage of certain discrete

frequencies or wavelengths. Microwave spectroscopy pertains to the spectroscopic art which falls in the microwave region commencing at a frequency of several thousand megacycles and continuing towards the spectrum of infrared. It is normally a negative indication based on critical frequencies which do not propagate through gaseous elements contained in a wave guide. The inability of specific frequencies to permit the passage of electromagnetic energy through individual elements or through compounds of elements provides a simple and reliable means of determining the presence, identity, magnitude, and relative concentration of molecular elements of matter.

Radio frequencies below about 30 megacycles are capable of reflecting

back to earth from ionized layers aloft. These are sky-wave frequencies. From about 30 megacycles to about 20,000 megacycles, there is a window in the atmosphere which permits direct-path communication without excessive attenuation.

Above 20,000 megacycles, there are encountered the "absorption frequencies." Lying between super-high frequencies and light are the so-called "black sheep" frequencies, involving absorption and scattering of radio waves by gases in the atmosphere. It has been found that water vapor (H_2O) produces molecular resonance at about 22,500 megacycles where propagational losses increase to over .4 db. per kilometer. Oxygen in the atmosphere is capable of providing maximum absorption or attenuation of microwave energy at a frequency of about 60,000 megacycles with attenuation being in the order of 10 decibels per kilometer. It gives fuel to the thought that every element or compound of elements, both known and unknown to science, have absorption frequencies.

In the past, identification of atoms

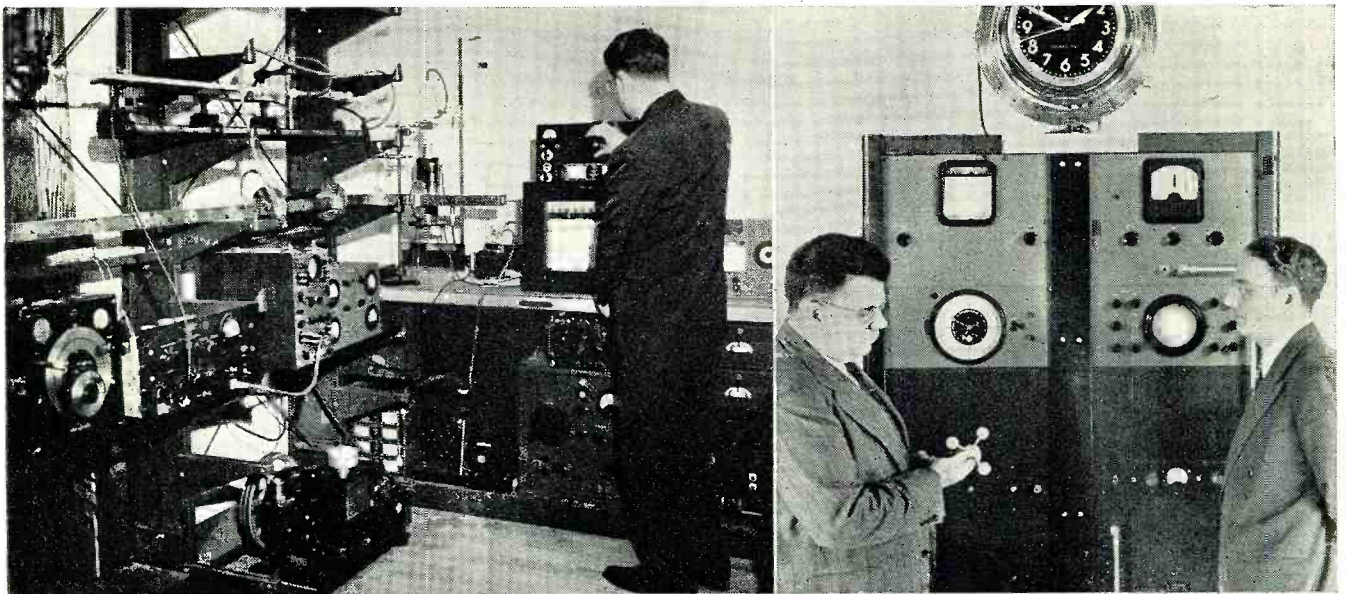

Fig. 2. (Left) Microwave spectroscopy laboratory at the National Bureau of Standards. (Right) Atomic clock controlled by the spectral line of the ammonia molecule contained in wave guide cell coiled around the clock. Dr. E. U. Condon, Director of the Bureau of Standards is at the left and Dr. Harold Lyons, head of the Microwave Standards Section is shown at the right.

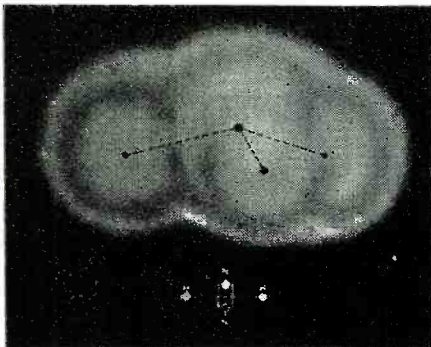

Fig. 3. Structure of ammonia molecule NH_3 .

and molecules by spectroscopic analysis has been dependent on infrared, optical, and ultraviolet methods. This was largely limited to work on atoms and the simpler molecules. It has not been suitable for analyses of large, complicated molecules such as are en-

countered in the fields of medicine and industrial chemistry. The heavier molecules, rotating at slower rates, usually have spectral lines which correspond to the frequencies or wavelengths in the microwave region rather than in the infrared, optical, or ultraviolet parts of the spectrum. Infrared is associated with heat, optics with light, and ultraviolet with chemical rays. The larger molecules for which microwaves are considered very promising are the ones associated with plastics, polymers, rubber, textiles, foods, oil, drugs, and biological chemicals, such as vitamins. Where microwaves are employed, the apparatus may be called a "microwave spectrometer" having a resolution up to 100,000 times greater than an infrared spectroscope. This makes possible the identification of isotopes, such as are supplied to industry and medicine by the Atomic Energy Commission at Oak Ridge, because it can deal with

the nucleus of the molecule. The other methods have been able to deal only with the outer parts of an atom or molecule. As a result, microwaves make possible measurements with very small isotopic samples. To date, about 500 elements or compounds of elements have been analyzed by microwave spectroscopy resulting from absorption or scattering of electromagnetic waves between 20,000 and 50,000 megacycles. It is only the beginning of a vast amount of research involving extension of the spectrum, working with a greater range of pressure and temperature, and utilizing a greater selection of microwave power in more sizes and designs of wave-guide plumbing.

The most interesting molecule likely to have earliest commercial application is that of ammonia. The constant frequency which can be derived from a microwave absorption line of ammonia gas provides an actual time constancy of one part in about ten million. Theoretically, a potential accuracy in the order of billions is indicated depending on the setup employed and the particular spectral line to be employed. It points the way to better utilization of the radio spectrum by reducing or eliminating the need for present, unduly wide, radio channels to take care of frequency drift.

In the past, one of the problems on microwaves has been precise and narrow frequency control. Quartz crystal oscillators are impracticable, because crystals become too thin and fragile, besides requiring a large number of frequency multiplication stages. Microwave spectroscopy now makes possible frequency stabilization on the higher microwave frequencies with an order of virtual perfection. Atomic oscillators and spectrum lines may be used as filters to give the necessary frequency control and stability. A filter can consist of a cell (such as a sec-

Fig. 4. Locations of the Atomic Energy program in the United States, a large part of which are facilitating their work by the use of microwave absorption phenomena.

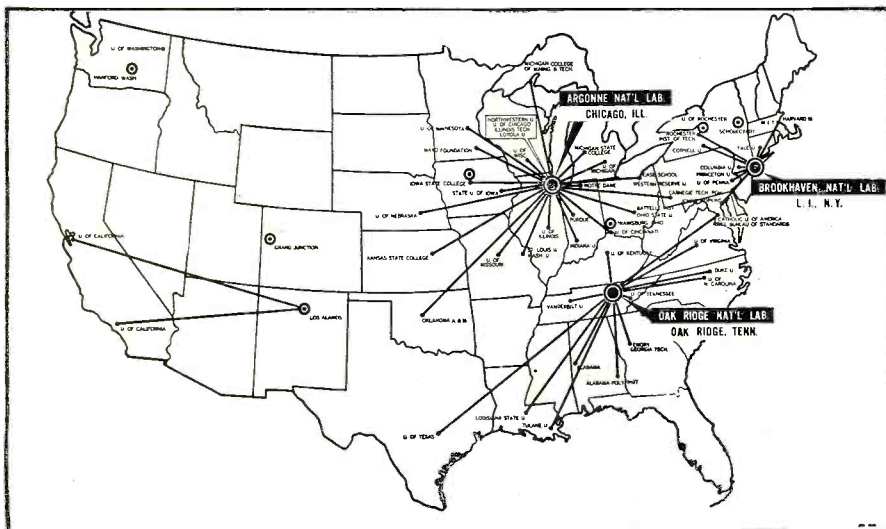

tion of wave guide seal at each end with mica windows transparent to microwave energy) filled with a gas that can absorb many different frequencies. Either bandpass or band-stop filters can be devised by the use of appropriate gas and microwave plumbing. Such filters can be electrically tuned by making use of the Stark effect. This is the name given where an applied electric field such as 100 kilocycles is applied to a metallic strip located in the center of a wave guide and insulated therefrom. It can force a molecule to change its frequency.

Fig. 3 illustrates the ammonia molecule (NH_3) comprising a nitrogen nucleus at the apex and three hydrogen nuclei at the base in the upper part of the figure. The ammonia molecule is in the form of a pyramid. Each nucleus is surrounded by its characteristic electron charge. The average distance between the nitrogen nucleus and each hydrogen nucleus is 1.01 angstroms (one angstrom is a hundred-millionth part of a centimeter, which in turn is .4 inch). The average distance between the hydrogen nuclei is 1.63 angstroms. The pyramid is about 0.38 angstroms high. The apex angle between hydrogen-nitrogen-hydrogen ($H-N-H$) nuclei is 107 degrees. When the ammonia molecule NH_3 absorbs energy at one sharply defined microwave frequency, it can turn itself inside out as illustrated by the diagram shown at the bottom of Fig. 3. Fig. 2 (right) illustrates the new atomic clock developed by the National Bureau of Standards, capable of keeping perfect time to within a second for a period of centuries by the use of ammonia molecule primary standard. The gas cell comprises about 30 feet of $\frac{1}{2}$ " x $\frac{1}{2}$ " rectangular wave guide tubing wrapped around the clock in Fig. 2. To the left of this figure, Dr. E. U. Condon, director of the Bureau of Standards, holds in his hand the model of the ammonia molecule. At the right is Dr. Harold Lyons, head of their Microwave Standards Section, whose group is responsible for this development. The scope portrays the spectral line of ammonia at a fre-

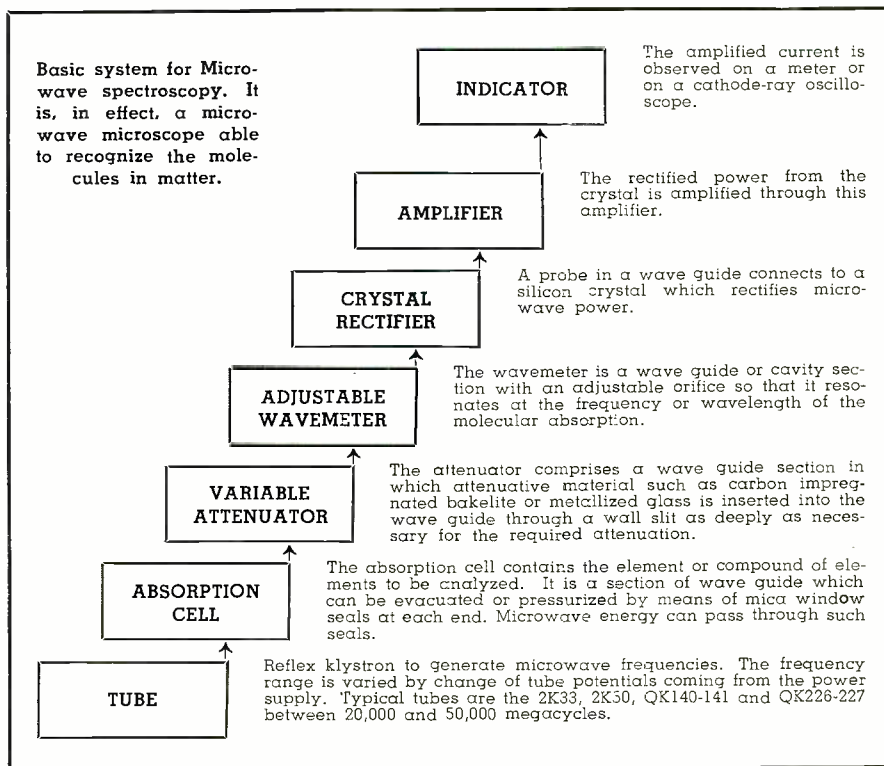

FREQUENCY IN MC.	RELATIVE INTENSITY	FREQUENCY IN MC.	RELATIVE INTENSITY	FREQUENCY IN MC.	RELATIVE INTENSITY
23694.49	3	25715.17	3	29061.14	1
23722.63	3	26518.91	3	29914.66	2
23870.13	4	26655.00	1	31424.97	2
24139.41	4	27478.00	3	33156.95	1
24532.98	3	27772.52	1	35134.44	1
25056.02	4	28604.73	2	39941.54	1

Table 1. Relative intensity versus frequency of ammonia absorption lines as measured against National Bureau of Standards station WWV.

quency of 23,780.1 megacycles. The strongest spectral line of ammonia is called 3,3 absorption line. It corresponds to the quantum transition in which two quantum numbers (called J and K) have the value of 3. The invariant frequency of ammonia, regardless of temperature, controls the timekeeping of the clock.

Below $1\frac{1}{2}$ centimeters, the ammonia absorption lines (shown in Table 1) have been measured against the

National Bureau of Standards Station WWV. The strongest (see Table 1) thus far has been 23,870.13 megacycles with a relative intensity of 4.

Fig. 2 (left) shows the microwave spectrometer assembly at the National Bureau of Standards, as it is used to extend the precision and frequency coverage of presently available absorption lines used as frequency standards. The pertinent portion

(Continued on page 131)

Fig. 5. (Left) Calibrated variable attenuator used for microwave spectroscopy. (Right) Micrometer type of wavemeter or frequency meter to measure frequencies employed in microwave spectroscopy.

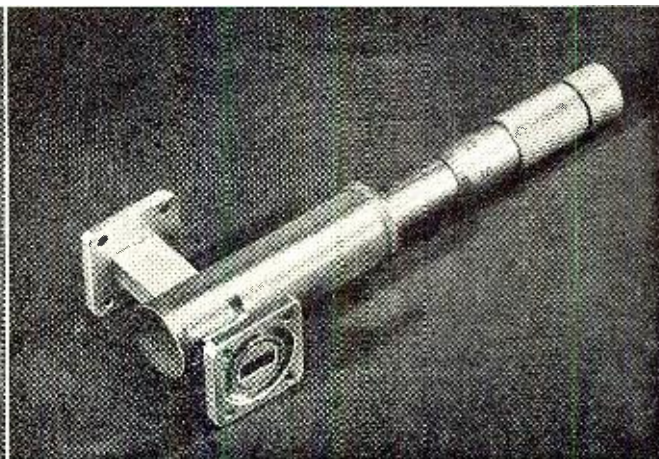
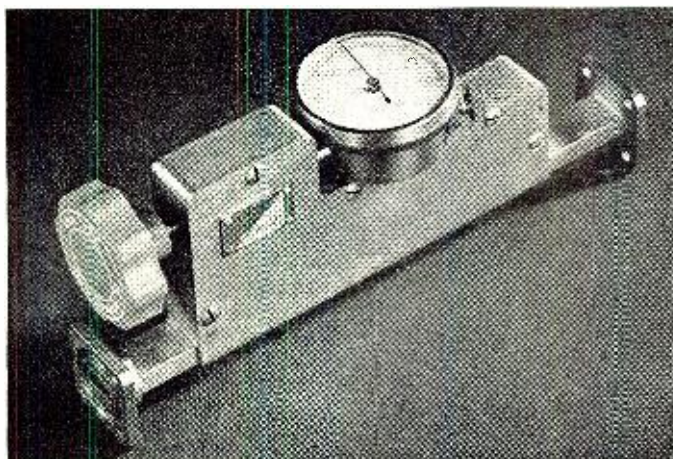



Television's IMPACT

By
HERBERT S. LAUFMAN

***Everyone is television conscious—whether
businessman, professional, or plain
private citizen—and all will feel its impact.***

slump is common knowledge. Everywhere people are wondering what is to become of this young giant—this baby that has forcibly kicked the slats from its crib and, in many instances, is soundly whipping its older brother, radio.

Let's look at the problem singularly. How will television affect our lives . . . and businesses? Will it change advertising as we now know it? Will the movies go out of business? Is vaudeville facing a rebirth? Will radio stations disappear? Is little Willie going to grow up near-sighted?

High school and college educations are being offered via the microwave. Recently an edict was issued that although people attended Mass via television, "it didn't count." This statement was not meant in a facetious vein. The entire nation is stirring and beginning to wonder, "Will this make us a more healthy, wealthy, well-adjusted nation, or in years to come will we find ourselves reduced to pale, myopic, slenderized, tenderized, super-streamlined, guaranteed-double-your-money-back physical and mental wrecks?"

Before this question can be answered, we must understand how completely television will reach into the various corners of this nation.

Obviously, if television were confined to the larger cities, its impact would not be as great as if the pictures were disseminated to every town, village, and hamlet. Today there are sixty-three television stations in operation, and 56 construction permits granted, while 325 applications are awaiting the go-ahead signal from the Federal Communications Commission. There are eighteen cities linked in a network extending from the Atlantic seaboard to the Mississippi River.

By 1951 a coast-to-coast network will be a reality, and stemming from this trans-continental line will be the arteries through which the rest of the nation will receive information and entertainment in sound and picture. Already engineers have developed a method for transmitting this high-frequency television signal so that it may be received more than a hundred miles from the transmitter. It is safe to assume that before many more years, even the most remote areas will be able to receive a television picture.

Confirming this forecast, Dr. Courtney Pitt, vice president in charge of finance of the *Philco Corporation*, Philadelphia, said recently that by 1950 production of television receivers should increase to over three million a year. He said over two million receivers would be manufactured in 1949 at a value approximating \$600,000,000.

"By the end of next year," Dr. Pitt stated, "There will be over six million television sets in daily use in American

Throughout the country, knowledge of the presence of television is made inescapable by the sight of antenna masts springing up from the tops of tall buildings. This CBS antenna in New York blends in well with the ultra-modern spire of the lofty Chrysler Tower.

"YOU ought to get into television now if you want to get in on the ground floor of a growing industry." That's a new voice in today's buzz of conversation. How different it is now from a mere two years ago when the comment was: "What—television? Come back and see me in five years. Maybe then I'll talk television to you."

Yes, television suddenly has arrived. Everyone has become television-conscious. Some psychologists are predicting the new medium will have a cohesive effect on the family unit. Others say that it will remove the last vestige of privacy from the home. Movie exhibitors are complaining that business has declined. Hollywood's

homes. No other industry in the history of America has ever grown with this amazing speed." He estimated that the television industry will expend \$5,000,000,000 in the next four years building and equipping stations and producing receivers, and that this year's television advertising expenditures will triple the \$10 million spent in 1948 on television time and program talent by advertisers. Now about 60,000,000 people are within reach of television service and "there is an immediate potential market for about 14,000,000 receivers in addition to the 1,200,000 already in use. By the beginning of 1950, we believe there will be about 155 television stations in operation serving approximately 80 million people, or over half of the nation's population."

The vicious circle that blocked television in its earlier days has largely been broken. Better programs have been made available by increased advertising revenue, in turn made possible because advertisers feel enough sets have been sold to make television a worthwhile advertising medium. No longer is the television set a curiosity restricted to barrooms and taverns. Music, variety shows, sporting events, dramas, on-the-spot news reports, tours through museums and educational institutions, and special events telecasts of everything from the stockyards to society weddings have moved television from the category of a luxury item to that of a near-necessity.

Set manufacturers are today competing for a market which, although eager to buy, is highly selective and economy-minded. According to a recent survey conducted for "American" magazine by Ray Robinson, director of research for the *Crowell-Collier* publishing company, the market is wide open for manufacturers to cultivate an open market. The survey unearths some very specific reasons why sets are not being bought. These reveal that prices and a feeling on the part of the public that sets will become cheaper and better are compelling obstacles to sales. Here is how they rank percentage-wise: can't afford, 52.65; sets will be improved—will wait, 45.7; sets will be cheaper, 24.1; not interested in present programs, 18.5; no need for additional entertainment, 12.1; lack space for set in home, 6.0; all other reasons 9.5.

The trend of television manufacturing today is toward a better and cheaper set, so that the main obstacle to sales at present, as reported above, will undoubtedly be overcome soon. Whereas in 1947 a mere table model television set cost from \$350 to \$700, today less than \$400 will buy a television set, radio-phonograph combination complete with attachment for the long-playing discs. Portable sets with 7-inch screens are selling for as little as \$135 today, and 16-inch picture tubes are available in console models for a little more than the cost of the table model of a year ago.

A factor which influences the set purchase is picture tube size. Unfortunately, too many people feel that television enjoyment is in direct proportion to the size of the

History is only one of the classroom topics to be presented on television. Shown here is a dramatization of the history of railroading, as presented by the television studios of CBS.



July, 1949



Agreement reached with the musicians' union begins the era of live music on television. Above: "Club Television" produced by WGN-TV in Chicago simulates a night club while the studio audience is placed at tables and used as part of the setting.

picture tube and are constantly looking for bigger pictures. When the 7-inch tube made its appearance, they waited for the 10-inch; after the 10-inch tube became available, the clamor arose for the 12- and 16-inch tubes. Now 24-inch and larger sizes are being requested.

The buying public must understand that picture tube size is not the regulating factor in their enjoyment of television, any more than the size of a movie screen is an important consideration in their enjoyment of a motion picture. We tend to move farther away from the screen in a large theatre and to sit closer to the front in a smaller house, and none of us feel for a moment that we are being cheated or deprived of the fruits of the program. This is not always evident because the size of the theatre varies with screen size, so although we may always sit in the center of the house, our linear distance from the screen is varied.

The same is true in television. You see just as much on a 7-inch tube as you do on a 16-inch tube. The only difference is you must sit closer to the set. In line with this, sitting close to a 16-inch or 24-inch tube creates the same effect as sitting too close to a movie screen—the picture is too large for enjoyment and the detail in scanning lines is too apparent for proper perspective. Thus we see that in small rooms, confined areas and intimate surroundings, the smaller tube is the more practical, while a larger picture is required when the viewers are forced to sit further away from the set, or a great number of people wish to watch at the same time.

The increasing numbers of (Continued on page 125)

Plato, Aristotle, philosophy, and the campus come into the home via television talks by Robert Hutchins, University of Chicago Chancellor, and Linn A. Williams, of the Great Books Foundation.



A 10-Meter Mobile TRANSMITTER

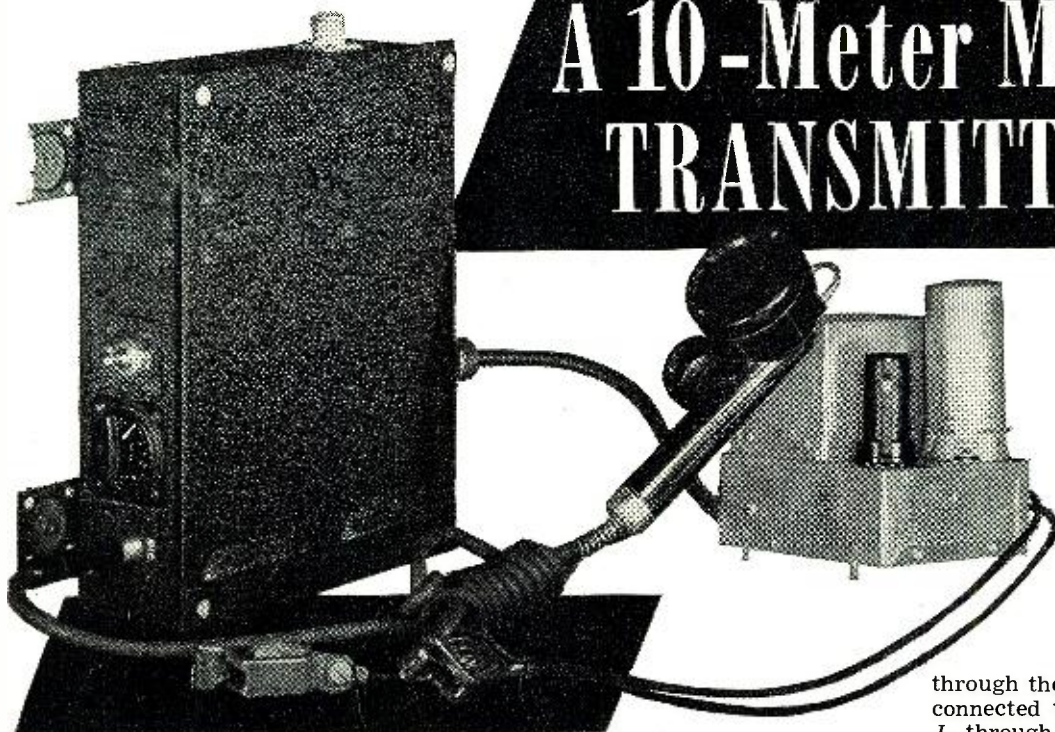

Fig. 1. External view of the mobile transmitter with microphone and power supply. Any similar power pack or even a dynamotor may be used in place of the vibrator type power supply shown.

By
RUFUS P. TURNER, K6AI

A low-power, exceptionally "thin" rig that may be stowed in any convenient corner of the car.

MUCH can be said in favor of keeping a mobile rig small in size. There is little point in cluttering the car with radio gear unless the owner and his XYL are among the few people who don't care at all about knee space and trunk space. It is a good idea, too, to use low power. This will reduce the additional load on the already hard-worked battery, and you can have a lot of fun with low power if you will operate intelligently.

The 10-meter mobile transmitter described in this article is the result of our determination to build a good low-powered rig in as thin a cabinet as possible. Measuring $8\frac{1}{2}$ " x 7" x $2\frac{1}{4}$ " over-all, it may be mounted conveniently up under the cowl, behind the driver's seat, on the "shelf" inside the rear window, or even on the inside of one of the doors, without getting in anybody's way. The vibrator-type power supply can be mounted inside the motor compartment under the hood. There is no need to appropriate trunk space for any portion of this transmitter, unless the operator so desires.

The r.f. portion of the rig contains three miniature-tube stages: a 6J6 dual triode is oscillator and doubler, and a 6C4 is the final amplifier. The audio section is a 6C4 speech amplifier, followed by a 6J6 push-pull modulator.

A surplus T17B carbon microphone is employed.

Transmitter Circuit

The complete circuit schematic is given in Figure 2. The first half of the first 6J6 tube serves as a 20-meter crystal oscillator, the second half as a 10-meter doubler. Grid resistor bias (R_2) is employed in the doubler and (R_3) in the final amplifier.

The improvised neutralizing condenser, C_6 , consists of two $\frac{3}{4}$ -inch lengths of No. 18 enamelled wire standing close to each other. One length is soldered to the No. 6 terminal of the 6C4 socket and extends through an ample clearance hole in the chassis; the other is soldered directly to the low end of coil L_3 . The capacitance of C_6 is varied by bending one wire toward or away from the other.

Final amplifier output is obtained

Table 1. Mechanical details of coil assemblies.

L_1 —23 t. No. 24 en. closewound on 9/16" diam. form
L_2 —11½ t. No. 24 en. on 9/16" diam. form, space to winding length of ½ inch
L_3 —10½ t. No. 20 en. on ¾" diam. form, space to winding length of ¾ inch; tap at 5¼ t.
L_4 —2 t. No. 18 or 20 d.c.c. w. closewound, self-supporting. Place inside L_3 form opposite L_3 center tap

through the link winding, L_4 , which is connected to the coaxial output jack, J_2 , through the upper contacts of relay RL_1 .

The 6C4-6J6 combination provides sufficient audio to modulate the signal nicely. No a.f. gain control is provided, since tests of the circuit beforehand did not indicate its necessity, and our decision was to eliminate all superfluous components.

A push-to-talk switch is mounted inside the microphone and is available through the special phone plug supplied with the mike. When this switch is closed, relay RL_1 closes, applying plate voltage to all stages and connecting coupling coil L_4 to coaxial output jack J_2 . When the push-to-talk switch is released, "B-plus" is removed from the transmitter, and the receiver is automatically connected to the transmitting antenna. The relay may be seen in the upper right-hand corner of Fig. 3. It is a revamped surplus unit which was completely rewound with No. 32 enamelled wire. Any 6-volt d.c. double-pole, double-throw relay may be used in this position, provided it has good contacts and short blades. The "On-Off" switch, S_1 , disconnects the entire transmitter from the battery during shut-down periods.

The d.c. plate voltage (300 v.) is supplied by a vibrator-type power supply. The power unit shown in Fig. 1 was a revamped surplus unit. Any similar power pack furnishing 300 volts at 100 milliamperes, such as Mallory Type VP-554 Vibrapack, Electronic Model 601, or A.T.R. Type 6, may be used with equal success. Some operators may prefer to use a 300-volt, 100 ma. surplus dynamotor for the job.

Mechanical Construction

The metal case housing the rig is $8\frac{1}{2}$ inches long, 7 inches wide, and 2¼ inches high. It was picked up on a

surplus table, but a case with similar dimensions can be produced by a local sheet metal shop. The shock mounts are Lord No. 3. A case of this size makes a "thin" transmitter which may be sandwiched easily into small spaces.

The "chassis" is a 10¼" x 6¾" aluminum plate (any other metal may be used), folded to give a 2-inch lip for mounting the tube sockets, crystal socket, and L_3 - L_4 coil form. After assembly and wiring are completed, this chassis plate is held to the bottom of the case by means of self-tapping screws.

The final amplifier tank coil, L_3 - L_4 , is mounted vertically, directly behind the 6C4 final amplifier tube. The oscillator and doubler coils are mounted on opposite corners of a ceramic plate salvaged from an i.f. transformer, and can be seen just behind the toggle switch in Fig. 3. The air trimmer condensers already mounted on this plate were cut down to 25 μ fd. for C_2 and C_3 . Their tuning screws can be seen in the other corners of the ceramic plate.

Tuning condenser C_1 is seen just below the 6C4 final amplifier tube, and is tuned by means of a short, perpendicular bakelite rod attached to its rotor shaft. Coils L_1 and L_2 are wound on National XR3 forms, L_3 and L_4 on a National PRF-2 form.

Although the audio transformers are mounted some distance from the tubes, we were not troubled with feedback or r.f. pickup. The grid and plate leads from these transformers run through shield braids, and the other leads are laced together, as may be seen in Fig. 3. An individual builder may prefer a different layout in which the transformers are mounted closer to the tubes.

Adjustment and Tuning

No attempt was made to include an antenna matching network of any kind inside the transmitter, since we wanted to be free to experiment from time to time with various external antenna couplers.

The oscillator and doubler stages may be tuned-up by means of a 2-volt pilot lamp connected to a 2-turn (½"-diameter) pickup coil of insulated wire. (1) Couple the lamp loosely to coil L_1 and adjust C_2 for maximum brilliance of the lamp. It will be advisable to check the oscillator frequency at this point with an absorption wavemeter to insure that the crystal is oscillating at its 20-meter frequency. (2) Transfer the loop to coil L_2 and adjust C_3 for maximum brilliance of the lamp. (3) To neutralize the 6C4 stage, remove the plate voltage temporarily to that stage only by disconnecting one of the milliammeter leads. Connect a d.c. vacuum tube voltmeter (or 20,000-ohms-per-volt non-tube voltmeter) across resistor R_5 , with the oscillator and doubler operating. Adjust the capacitance of neutralizing condenser C_6 until a

(Continued on page 115)

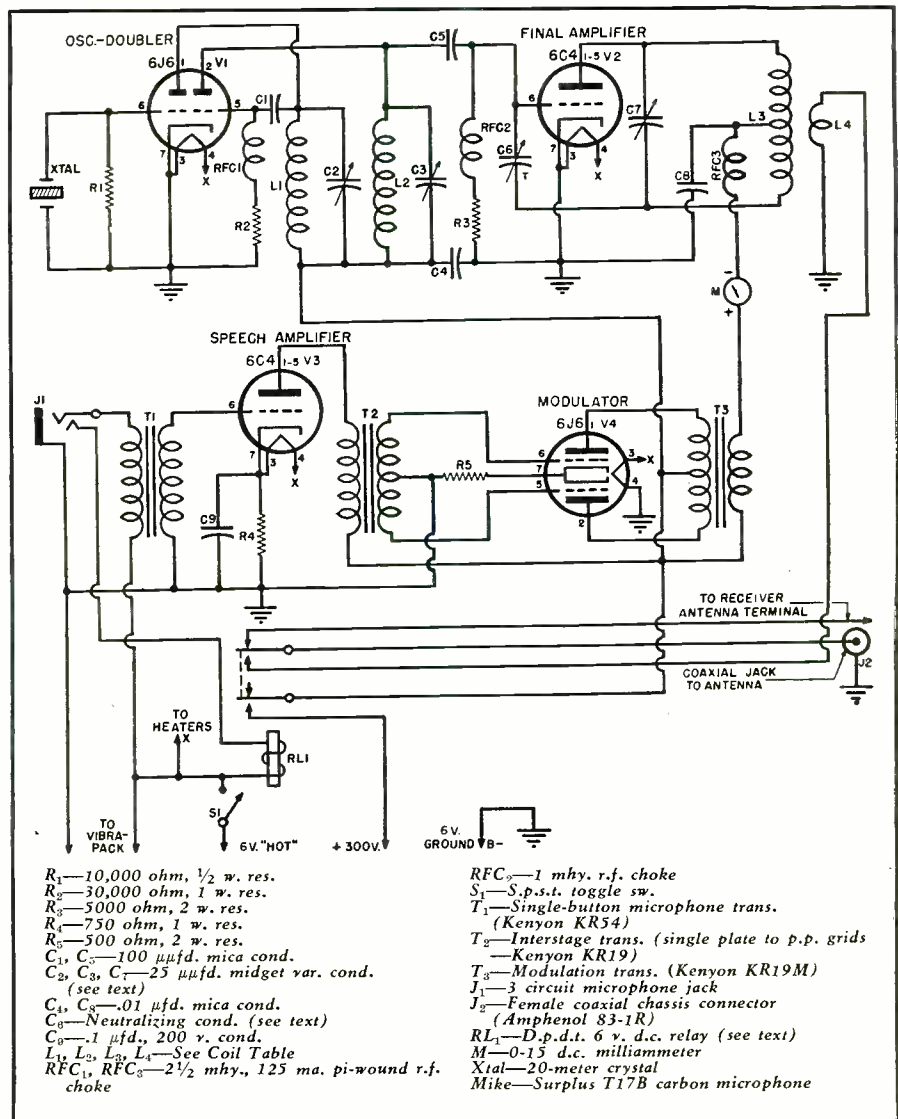
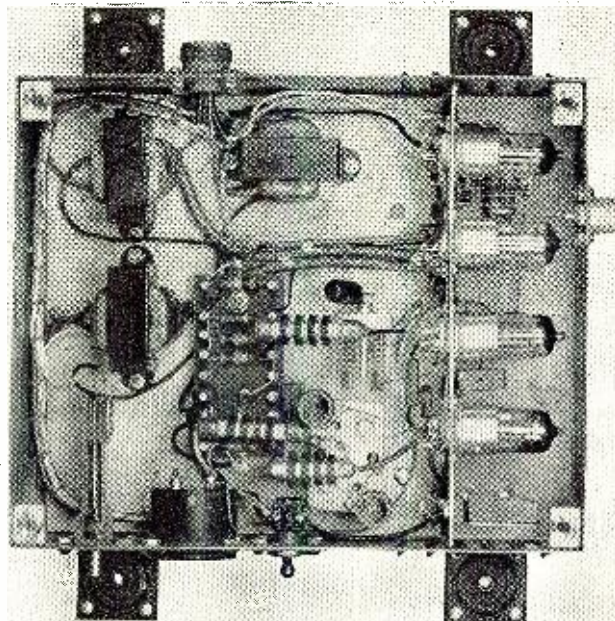

Fig. 2. Diagram of the mobile transmitter—a separate vibrator type power supply producing 300 volts at 100 ma. was used. Power supply is shown in Fig. 1.

Fig. 3. Inside the case—showing all components and wiring. The tubes shown on right-hand side of chassis from top to bottom are V_3 , V_1 , V_2 , and V_1 , respectively.



By **WALTER B. FORD, W6YT**

A must for all uranium prospectors seeking the \$10,000 AEC bonuses—these portable or laboratory type Geiger counters will indicate the presence of radioactivity



Fig. 1. The author, using the portable type Geiger counter.

Build Your Own GEIGER COUNTER

THE rush to find new sources of uranium is on. Although they are not confined to a particular area, as in the great California Gold Rush of just a hundred years ago, the increasing numbers being attracted daily to this newest phase of prospecting promise soon to make the "Forty-Niners" seem a mere handful by comparison. Perhaps the greatest incentive to searchers for radioactive materials is the recent announcement of the Atomic Energy Commission offering a bonus of \$10,000 for the discovery and production of high-grade uranium ore from new domestic deposits and guaranteeing three-year minimum prices for ores of lower grade.

An essential tool for the prospector for radioactive materials is the Geiger-Mueller counter, a device for detecting radioactivity, named after the physicists who pioneered in that field and made the present-day counter possible. While there are various other ways of detecting radioactivity, the procedures are generally so time-consuming that they will not be consid-

ered here. For the serious worker in the field of radioactive materials, whether he is a prospector or experimenter, the radiation detector he is using should be capable of producing instantaneous readings. The modern Geiger counter meets that requirement, and it is with the thought of meeting the needs of those particular RADIO AND TELEVISION NEWS readers that construction details for two types of Geiger tube counters are offered. One of the counters is a lightweight model for field use, and the other is for use in the laboratory.

Before getting into the construction details, a brief theory discussion on the operation of the Geiger counter will perhaps be of interest. Basically, a Geiger tube consists of a glass envelope, sealed at the ends, with a thin tungsten wire running through its center, and surrounded by a copper cylinder. Lead wires connected to the tungsten wire and the copper cylinder are brought out through the ends or the sides of the glass envelope. Before the glass envelope is sealed, it is

evacuated and various gases are inserted. The glass envelope is placed in a metal tube, covered at one end, and lined with sponge rubber to protect the glass envelope. The opposite end of the probe terminates in a fitting, which in turn makes connection between the leads from the glass envelope and a piece of concentric cable. In operation, the center wire is connected through a resistor-condenser network to the grid of an audio amplifier. Connected to the same center wire through a high resistance is a source of d.c. high voltage. Normally, the gases within the Geiger tube are in a non-conductive state, but when emanations from a radioactive source enter the tube, the gas becomes ionized and a pulse of current flows, which is amplified by the tube of the audio amplifier. If no means were used to stop the flow of current between the Geiger tube elements, the tube would go into a continuous discharge and become useless as a counter. It is at this point that the terms "non self-quenching" and "self quenching" come up for consideration. One method of preventing continuous discharge within the Geiger tube is to insert a resistor of the order of several hundred megohms in the high-voltage lead to the tube. Once the original atomic emanations have ceased, the drop in voltage across the resistor is great enough to restore the tube to

its original state. Another way of accomplishing the same result is to add a vacuum tube to the circuit solely to quench the discharge within the Geiger tube. Both of the above methods come under the classification of non-self-quenching circuits. In a self-quenching Geiger tube, certain gases are inserted in the tube to stop the flow of current between the tube elements the instant the radio emanations stop. While there are proponents of both methods of quenching, after having built several counters of both types, the author is convinced that from the constructor's viewpoint the self-quenching counter is much to be preferred. Many of the foremost manufacturers of Geiger counters use self-quenching tubes in their counters, and the fact that Geiger tubes may be obtained separately from many of the same manufacturers assures the constructor that he may readily obtain this most important item.

Laboratory Type Geiger Counter

The Geiger counter described will prove a very worthwhile addition to the laboratories of those experimenters whose interests extend into the field of nuclear physics. Because of the dramatic way in which the effects of radioactivity are indicated on the instrument, it should be equally valuable in the classroom or wherever else the effects of atomic emanations are demonstrated.

The amplifier consists of a two-stage unit in which the pulses are indicated by flashes on a neon light accompanied by loud clicks in the loudspeaker, or by the neon light alone. This last feature is particularly desirable where the loudspeaker noises might become annoying to the operator over long periods of time.

The chassis layout is shown in Fig. 3. The author used a standard 7"x11"x2" chassis, but some readers may desire to make their own.

The circuit diagram follows the con-

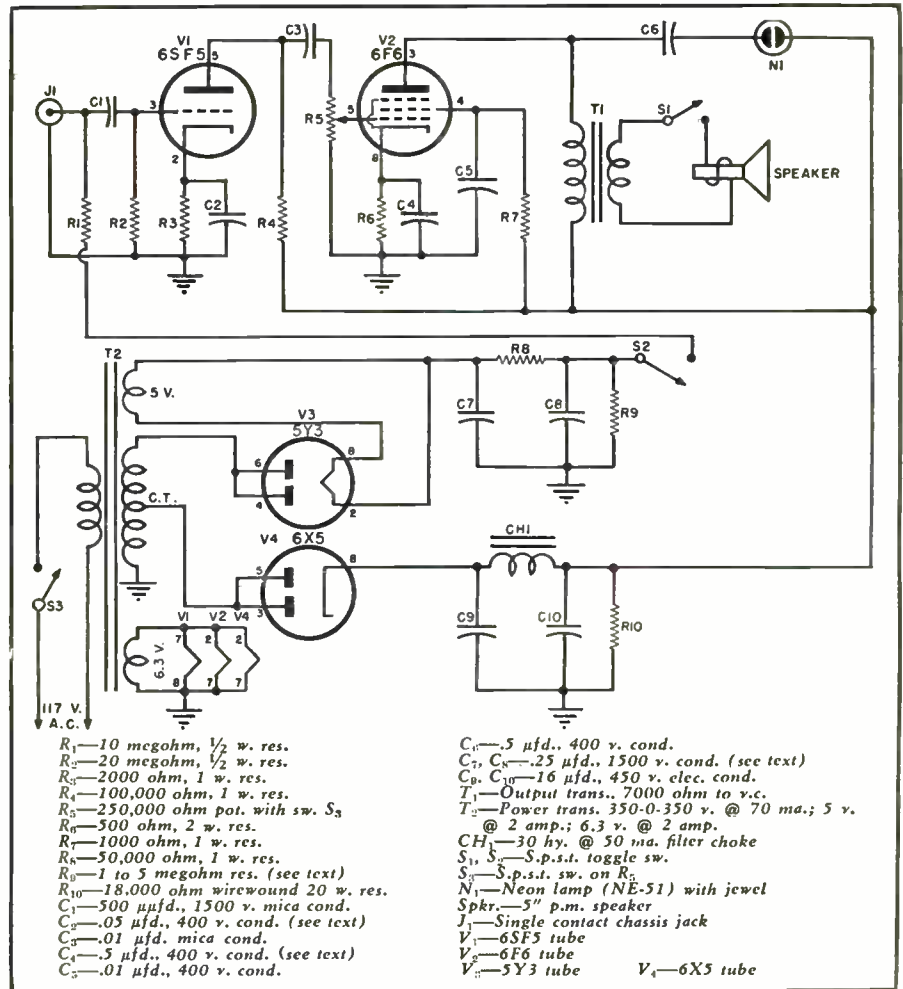

Fig. 2. Schematic diagram of the laboratory type Geiger counter. Radioactivity pulses are indicated by flashes on a neon light and loud clicks in the speaker.

ventional audio frequency amplifier, with the exception of the input circuit and the neon light indicator. Owing to the high value of the grid resistor of the 6SF5 input tube, hum is apt to be pronounced unless the builder makes the input leads as short as possible. A further aid to keeping hum

to a negligible amount is to shield both the grid resistor and the 500 μ fd. coupling condenser. Since we are not concerned with any particular frequency response, the condensers C_2 and C_4 are much lower in value than would normally be required. In fact, when they were removed entirely there was

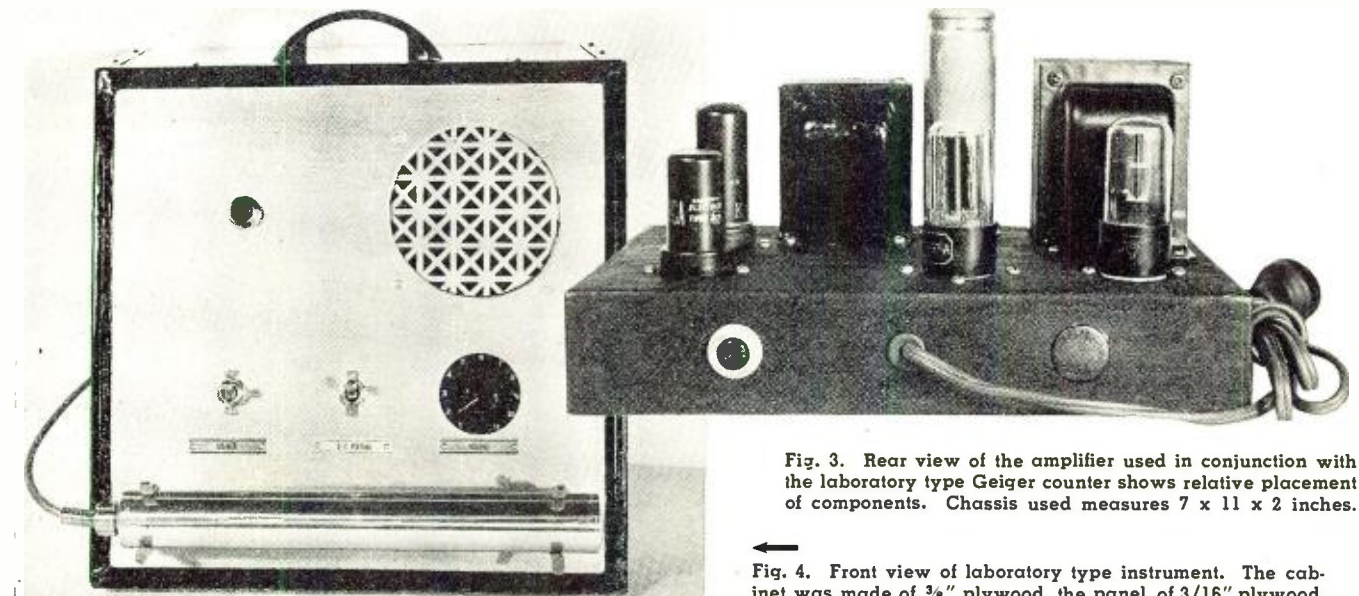

Fig. 3. Rear view of the amplifier used in conjunction with the laboratory type Geiger counter shows relative placement of components. Chassis used measures 7 x 11 x 2 inches.

Fig. 4. Front view of laboratory type instrument. The cabinet was made of $\frac{3}{8}$ " plywood, the panel, of $\frac{3}{16}$ " plywood.

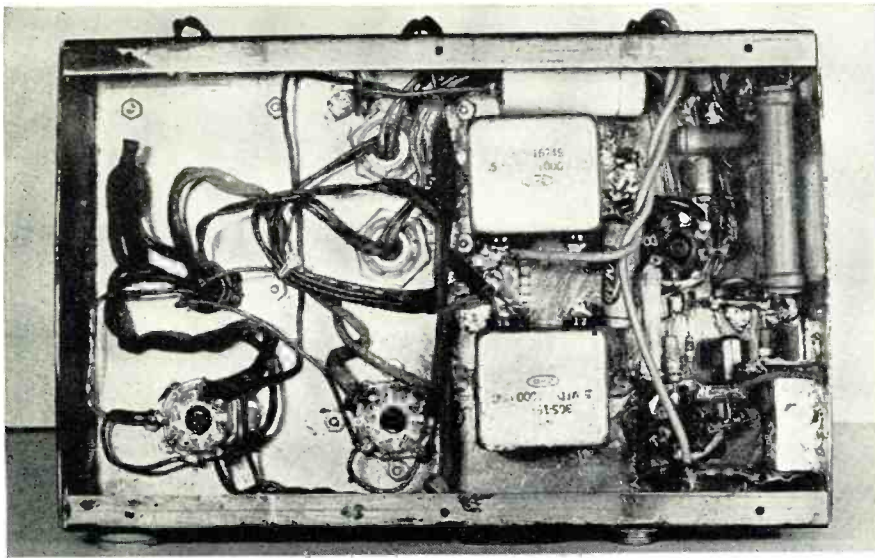

Fig. 5. Under-chassis view of amplifier used in conjunction with laboratory unit.

no noticeable difference in the operation of the amplifier, but they were reinserted to obtain the maximum gain possible from the stages.

The high-voltage leads which extend from the high-voltage power supply and R_1 to S_2 on the front panel should be flexible rubber covered test lead wire and should pass through one of the grommets on the front of the chassis. Leads from S_3 and R_2 extend through another grommet, with the neon light leads going through the remaining grommet. Leads from the loudspeaker voice coil and transformer go directly to S_1 on the front panel.

The power supply is unique in that it provides high voltage for the counter tube from a conventional low-power transformer and is similar to some television power supply circuits. The plate voltage for the amplifier tubes is obtained through a 6X5 tube from the center tap of the transformer and an outside lead, which is grounded. The other lead from the transformer is connected through a 5Y3 tube, act-

ing as a half-wave rectifier similarly to the 6X5, then to the filter circuit and the Geiger tube resistor. Since the current drawn by the counter tube is a negligible two or three microamperes, the voltage available from the 5Y3 tube will approach the peak value and will be approximately 1000 volts. And because the current drain of the Geiger tube can be ignored, the builder has within his means almost perfect regulation of the high-voltage circuit. The voltage available will be determined by the current drawn from the power supply and may be regulated to fine degree by varying the value of bleeder resistor R_3 . A simple way to check the voltage is to insert a low reading milliammeter in series with R_3 and calculate the voltage from Ohm's law. A switch, S_2 , is provided in the high-voltage lead to protect the counter tube from surges when the power is first turned on and to provide a standby switch to keep the amplifier active, yet conserve the Geiger tube when it is not in use. The con-

Fig. 6. The heart of the portable unit is relatively small and compact.

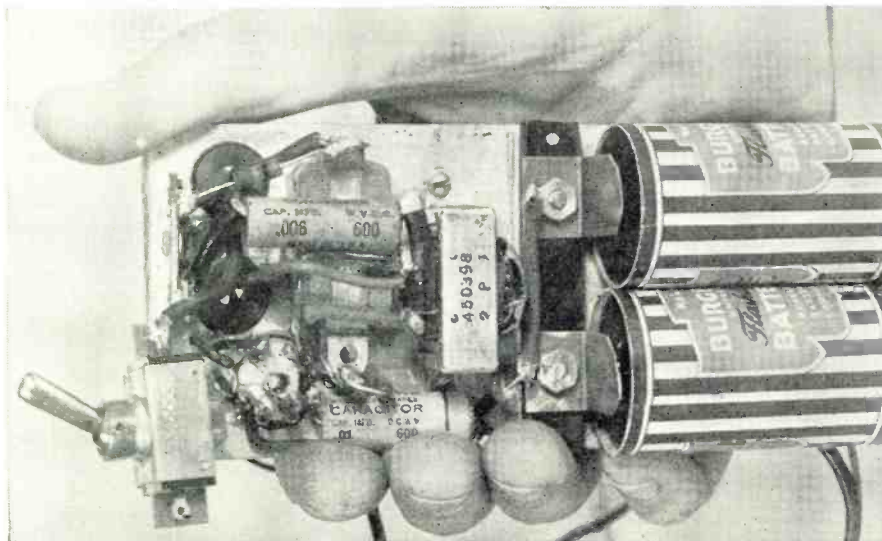

densers used in the high-voltage filter circuit, C_1 and C_2 , were obtained from war surplus and consists of two .5 μ fd, 1000 volt condensers connected in series for each unit.

The layout for the front panel of the cabinet is shown in Fig. 4. The author used 3/16" plywood for the panel and 3/8" plywood for the cabinet, but other materials may be substituted if the builder so desires.

The switches on the front panel should be provided with "On-Off" plates, and the operation of the unit will be greatly facilitated if name plates are provided for the various controls, as shown in the photograph. Any one of the three colored jewels available may be used with the neon light, but the maximum light will be obtained with one of amber color. Where a number of different operators will work with the counter, providing spring clamps on the face of the panel for holding the Geiger tube will be a worthwhile precaution against breakage. It is just as easy to bring the specimens to be tested to the tube as it is to reverse the operation.

The Geiger tube for the laboratory counter should operate at 1000 volts and should be of the self-quenching type. While it would be possible for the counter builder to make his own probe for holding the Geiger tube, it is strongly recommended that both the tube and probe be bought as one unit. An unmounted Geiger tube is generally a rather fragile affair and is easily damaged by one not familiar with handling them.

Portable Counter for Field Use

The portable counter is contained in a metal box, 8"x6"x2 3/4". The author used 20-gauge sheet steel, but sheet brass or aluminum may be substituted. The whole assembly makes a very compact unit and weighs less than six pounds, including all batteries. In addition to the "A" and "B" batteries which operate the counter amplifier, an additional 900 volts of battery is required for the Geiger tube. While there are two substitutes for the high-voltage batteries, namely, a vibrator unit with a small storage battery, or a radio-frequency oscillator, the added weight and space requirements for either one defeat the very purpose for which a field unit should be designed, that of extreme portability. Since the load on the high-voltage batteries is only a few microamperes, they will last about two years, the estimated shelf life.

The case for the counter is made from sheet metal, shaped as shown in Fig. 1. The carrying strap loops are also shown. Since these loops must support the weight of the counter, they should be either bolted or spot welded to the case. The "B" battery retainer should be secured to the lower right-hand side of the case, as shown in the assembly view, Fig. 8.

Mount the audio choke and the tube

(Continued on page 72)

New TV SCREEN Offers Greater Contrast

Improved contrast and less eye-strain are the result of a newly developed cathode-ray tube screen. Tubes using the new screen are now available in 10- and 12-inch sizes and may be used to replace conventional tubes without circuit changes.

By

U. A. SANABRIA

Pres., American Television, Inc.



The author with a production model of the new, direct-view television tube.

NE of the most persistent complaints voiced by users of television receivers is directed against eyestrain that develops after the screen has been viewed continuously for more than an hour. One of the chief reasons for this trouble stems from the inability of current fluorescent screens to provide images possessing adequate contrast. To see why this is so, let us consider the behavior of a fluorescent screen when bombarded by an electron beam.

In the usual cathode-ray tube screen, the phosphorescent powder is crystalline in structure. When the electron scanning beam impinges on a small group of these crystals, light is uniformly emitted in all directions. (See Fig. 1.) The only desirable direction for the light to travel is toward the viewer. The remainder of the emitted light either travels back into the tube or sideways toward the neighboring crystals. At these other crystals the light suffers reflection and dispersion, with the result that illumination from the crystal or clustered group of crystals directly under the electron beam appears also at other points throughout the screen.

Instead of obtaining a sharply defined spot on the screen, we now see a bright blob of light, with intensity decreasing rapidly with distance in the immediate vicinity of the bombardment point, and then slowly as the distance becomes relatively great. This behavior has the effect of causing black areas in the image to appear grayish in color, sometimes referred to

as a washed-out black. An observer viewing an image on a conventional cathode-ray tube screen under normal light conditions in the home finds that he must set the contrast control at a point which provides excessive illumination of the white portions of the image in order to achieve what he considers adequate contrast. Actually, as a moment's reflection will indicate, the blacks do not become blacker by this action; in fact, they become more grayish in shade due to the greater amount of reflected and scattered light. However, the illusion of deep black is created because of the eye fatigue resulting from the greater intensity of the whiter portions of the image.

It was to combat this undesirable light scattering that research at the Tube Division of American Television,

Inc., was directed. The objective was to imprison and localize the light created by the electron beam on the luminescent screen so that side dispersion was entirely eliminated. Investigation revealed that the use of an opaque powder such as manganese dioxide in combination with sodium metasilicate dispersed among the phosphorescent crystals works in a satisfactory manner. The manganese dioxide provides a barrier between the luminescent particles, the latter being exposed only on the back for impingement of the electron beam and at the front for suitable luminescence in the formation of the image. The opaque material acts to confine the light emitted from each crystal to the crystal itself, so that a white picture element

(Continued on page 98)

Fig. 1. A relative comparison of the light ray scattering in a conventional cathode-ray tube screen (A), and a television tube with corrected screen (B).

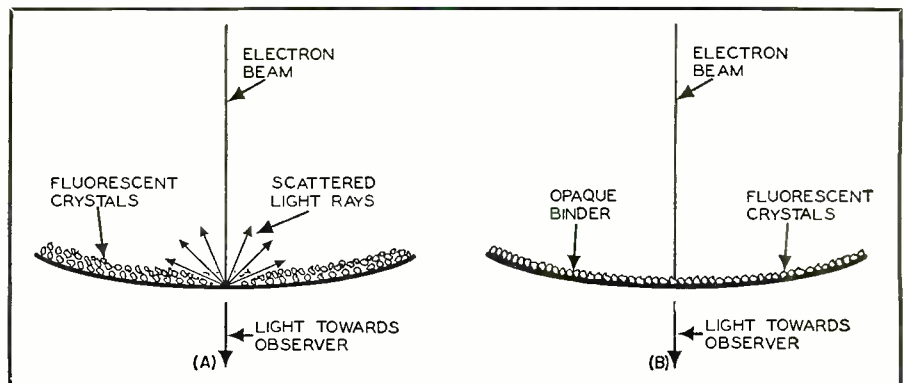



By
MILTON S. KIVER

***Part 16. Servicing techniques for Intercarrier TV systems,
comparing various problems encountered
in these receivers and conventional TV sets.***

THE differences between the conventional and Intercarrier television systems will necessitate some changes in the servicing technique of these latter receivers. In Intercarrier sets we know, for example, that the picture signal must be present at the video second detector in order for the 4.5 mc. beat note to be developed. Thus, if no sound or video output is obtained from a receiver, but a scanning raster is present on the screen, the difficulty may exist at one of two places. There is a possibility that no video carrier is being transmitted by the broadcast station and this may quickly be checked on another receiver. This second receiver should preferably employ the conventional television system, although a set operating by the Intercarrier method will also serve satisfactorily. Absence of any image on either of these receivers indicates that no video signal is being received from the station. Another test that immediately suggests itself is to switch to another channel on the same receiver and to note whether any image is obtained.

If it is found that a video carrier is being transmitted, but neither sound nor image output is obtained from the receiver, the difficulty must lie in one of the stages preceding the point of separation of the 4.5 mc. audio signal from the video system. Check the schematic diagram of the receiver to determine exactly where this point is. In some sets it occurs at the output of the first video-frequency amplifier; in others it occurs just prior to the cathode-ray tube. See Fig. 1. Wherever it is, work from this point forward toward the front end of the receiver. Tubes are checked first. If these are good, then an AM signal generator should be used to determine where the signal path is broken. Remember that the appearance of an image on the screen is not dependent upon the presence of the sound signal. To test the video-frequency amplifiers, connect an audio oscillator across the video detector load resistor and observe whether black and white horizontal bars appear across the screen. See Fig. 2. These will be seen if the video-frequency amplifier is operating. If

this stage tests okay, we turn next to the i.f. system. To test the i.f. system, all we need do is set an AM signal generator at the video carrier intermediate frequency, amplitude modulate this with the internal 400-cycle or 1000-cycle note of the generator and watch for the appearance of black and white bars on the screen. Any one of the AM signal generators on the market covering the i.f. range (20-35 mc.) would be suitable. Start at the i.f. stage nearest the video second detector and progressively move toward the mixer until the defective stage is located. To test the r.f. end of the receiver, if this becomes necessary, connect the output leads of an r.f. signal generator to the input terminals of the receiver. Set the generator at the video carrier frequency for the channel to which the receiver is tuned. This signal should also be amplitude modulated. If the r.f. amplifier, mixer, and local oscillator are operating, black and white bars will again appear across the screen. If this indication is absent, check tube voltages, especially the grid voltage of the oscillator.

The appearance of an image on the screen, with no accompanying audio, will almost invariably mean that the trouble lies in the sound system. This includes the 4.5 mc. amplifier, the FM

detector, and the audio amplifiers. Conversely, the appearance of sound but no image means that the video path, following the point of separation, is open. See Fig. 3. This may include a video amplifier tube (if any), the cathode-ray tube, or coupling condensers and resistors. The amplifier tube is best checked by substitution. The cathode-ray tube is checked by inspection, noting whether or not a raster is visible and whether rotation of the brightness control has any effect on the raster intensity. Affirmative answers to both these questions indicate that the cathode-ray tube is okay. The simplest remaining method of finding the break is by means of an oscilloscope. Start at the separation point and move toward the grid (or cathode) of the cathode-ray tube, noting where the video signal disappears. See Fig. 4. At this point employ resistance and/or voltage checks to localize the defective component.

The foregoing defects will present few difficulties to the service technician as long as he understands the basic operation of the Intercarrier television sound system. A far greater headache is the appearance of a 60-cycle buzz from the sound channel. A common complaint made by the customer is that the set was operating properly when first bought, but that it now contains a buzz which is present only while the station is on the air. If the station goes off the air or the set is switched to a channel on which there is no station, the buzz disappears. Here are the causes for this annoyance and how it may be corrected. (Not infrequently, service technicians will be called upon to service brand-new sets which also possess this buzz. The method of attack for these receivers is the same as that for the above receivers.)

In the preceding discussion outlining the basic operation of sets employing the Intercarrier system, great stress was placed on the fact that the level of the sound carrier should be considerably lower than the level of the video carrier. One reason for this was due to the amplitude modulation that would be imparted to the 4.5 mc. beat note if the two carrier levels became comparable in amplitude. When this modulation becomes great enough, the audio system is unable to eliminate it, and the audio output becomes distorted. This, essentially, is the main reason for the appearance of the 60-cycle buzz. At some point prior to the sound take-off point, the sound signal receives enough amplitude modulation to appreciably affect the FM detector.

The buzz frequency is 60 cycles because the amplitude of the synchronizing pulses is considerably greater than any other single component of the video signal and if the FM signal is amplitude modulated at all, it is generally by the 60-cycle vertical sync pulses or the 15,750-cycle horizontal sync pulses. Since a frequency of 15,750-cycles is inaudible to most people, only the 60-cycle buzz is noted.

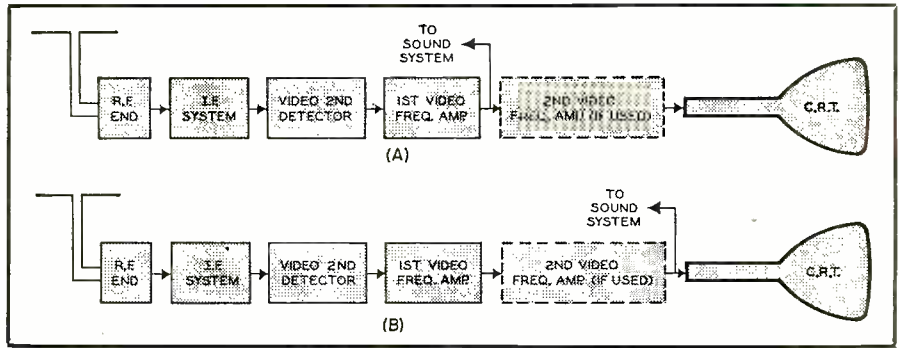

Fig. 1. Block diagrams show the two points of signal separation most commonly used in Intercarrier sound system television receivers.

Appreciable amplitude modulation may occur in any of the video-frequency amplifier stages following the video second detector. These video amplifiers usually are designed to operate with a fairly large grid swing. However, any significant change in operating voltages will cause the amplification and transconductance of these stages to vary considerably under the influence of the video and sync modulation of the television signal. Any significant variation in amplification will produce amplitude modulation of the 4.5 mc. beat note signal. Hence, proper operation of these stages is most important. Overloading due to a decrease in the emission of one of the video tubes, a change in bias voltage, or a decrease in plate or screen grid voltages (due either to the power supply or to a change in the component parts values) will all cause the appearance of this 60-cycle buzz. Thus, as a first step in eliminating this annoyance, check the screen, plate, and control grid voltages of the video amplifiers, and compare these with the values specified by the manufacturer. A variation of more than 10 per-cent can be significant.

Another cause for amplitude modulation of the 4.5 mc. signal is overloading of the i.f. amplifiers. When overloading occurs, the gain supplied the sound carrier varies with the video and sync modulation. Here again check the tube voltages to determine whether the stage is operating as specified by the manufacturer. The audio buzz may appear only when the contrast control is too far advanced, disappearing when the control is set at a lower video level. In this case, insertion of an attenuation pad between the transmission line and the receiver will decrease the incoming signal strength to the point where advancing the contrast control to maximum will permit a good image to be obtained without resulting in the audio buzz.

Buzzing may also be due to improper alignment of the 4.5 mc. take-off coil or of the FM detector transformer. In nearly all Intercarrier receivers, some amplitude modulation is imparted to the 4.5 mc. beat note. When the sound system and the FM detector transformer are properly aligned, the system is in its optimum operating condition for eliminating the effects of any small amount of amplitude modulation in the 4.5 mc. signal. Any deviation from this aligned condition will decrease the ability of the system to combat interference. Hence, carefully check the frequency response and line-

(Continued on page 95)

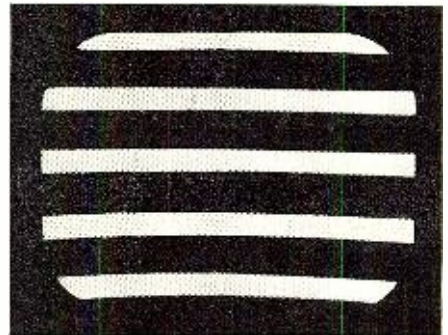

Fig. 2. Indications that are shown on the image tube screen when the tests covered in the article are performed.

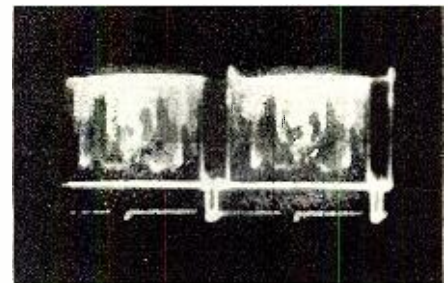
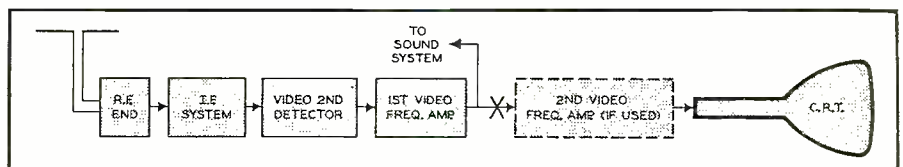

Fig. 4. The video signal at the grid of cathode-ray tube, as it appears on oscilloscope.

Fig. 3. The appearance of normal sound output but no picture indicates that the defect exists in the second video amplifier (if any) or the cathode-ray tube circuit.



Mac's RADIO SERVICE SHOP

By JOHN T. FRYE



Advertising for Dessert

IT WAS well after one-thirty when Mac, just back from his lunch period, strolled into the service department of his radio shop. He ran straight into an accusing look from Barney, his apprentice, who stood at the service bench pointedly tapping his foot and glancing at his wrist watch.

"Boy!" Mac exclaimed, blandly ignoring this act and mopping his face with a handkerchief, "it's hotter out in that sun than a ballast tube's shell!"

"You can talk plainer than that, and don't try to evade the subject," Barney said sternly. "Where have you been loafing?"

"Say, Red," Mac said, ignoring the question completely and speculatively eyeing the boy's glowing thatch, "would you mind wearing some kind of a cover, say a snood, over that hair of yours these hot days? Every time I look at it, I feel just as though I were sitting in front of an open fire—"

"Oh, all right!" he suddenly broke down with a chuckle. "If you won't dock me this time, I'll tell all. The first and third Tuesday in every month, a gang of us radio service technicians have an informal little get-together over at The Dutchman's during our lunch hour. Every guy buys his own dinner; but after lunch, while we are messing around with the dessert, we talk about some phase of the service game. Each meeting we try to talk about a different subject. Today we had cherry pie *a la mode* and advertising."

"Who started all this?" Barney asked suspiciously.

"Well, I guess I did; and I'm glad," Mac replied. "It's working out even

better than I hoped. It is funny how that so-and-so down the street, who was a chiseling, price-cutting, cold-solder-joint radio butcher before you met him, can turn out to be a pretty good sort when you look at him over a bowl of chili or a big plate of spaghetti-and-meat-balls. It's strange, too, how you find out that he is getting gray hairs wrestling with the same problems you have, and how just talking things over with him seems to shrink those problems down to size. We are picking up new members every meeting day, and I should not be surprised if this thing grew into some kind of a service technicians' organization one of these days."

"Did you get any new ideas on advertising along with that cherry pie?" "Lots of 'em," Mac admitted promptly.

"For instance?" Barney prodded.

"For one thing, we decided that the old saw about word-of-mouth advertising's being the very best kind for a radio service business needed considerable qualification. That sort of publicity has a lot of variables over which the service technician has no control. Its worth depends on how gabby your customers are, how many friends they have, and so on. In a large city, where very little neighboring goes on, the effectiveness of this kind of advertising is considerably less than in a smaller community where the people do more talking to each other.

"Now do not get the idea that we are opposed to doing good work and behaving courteously so that our customers will recommend us to other people. Far from it! What we decided was that it was foolish to *depend entirely* on that kind of a business-builder. At

best, it needs lots of time to do its good work. After a business is well established, word-of-mouth advertising can do much to keep it going; but other types are required to launch a new business or to pep up a puny one."

"What are some good types?"

"Archie, of *Archie's Radio Service*, has spent more money on advertising than anyone else in town, and he has kept a pretty close watch on results; so all of us were interested in his opinions. He says that his most spectacular results come from direct-mail advertising. Those return-postage double-cards give you a chance to see exactly what results you are getting. He pointed out, though, that you had to watch little things in that kind of advertising. For example, he found that cards addressed by hand to specific persons brought in a far greater return than those addressed on a typewriter or those sent to the 'occupant' at a certain address. Apparently a lot of other people just glance at the less personal ones and throw them into the wastebasket.

"He says that about the next best thing for quick results is a good-sized 'special' ad in a newspaper. For example, a Spring or Fall flat-rate, 'clean-and-check' offer invariably gets good results for him."

"How about running a small ad regularly?"

"Bill has a special angle on that sort of thing. He calls it 'riding the coat-tail of the national advertisers.' By that he means that he tries to tie in his own advertising with national advertising by big companies. As an example, the tube manufacturers have spent millions of dollars implanting in the minds of the people that good tubes mean good reception, and proof of how well they have done their job is contained in how often we hear that phrase, 'I think it must be a tube.' Bill runs a little ad continuously that simply says he tests tubes free of charge—meaning tubes out of the set, of course. He says this inexpensive little ad pays for itself in tube sales alone; but it also makes many new contacts for him and brings in several repair jobs when it is found the trouble is not in the tubes."

"Does Archie think those big-as-a-bed-sheet calendars he puts out pay off?"

"Yes, he is convinced that they do. He says that lots of people who call him say that they noticed the calendars. Those jobs cost better than a dollar each, and he says there are several angles to be considered. For one thing, he tries to put them into banks, beauty shops, license bureaus, and barber shops, as well as taverns, garages, and pool rooms. That means that the picture must be one that is acceptable in any company. In short, 'cheese-cake' pictures are out. Another important point is to have the calendar hung in a good place. That is why he always 'happens' to have a tackhammer with him when he distributes a
(Continued on page 124)

A Modern MOBILE TRANSCEIVER

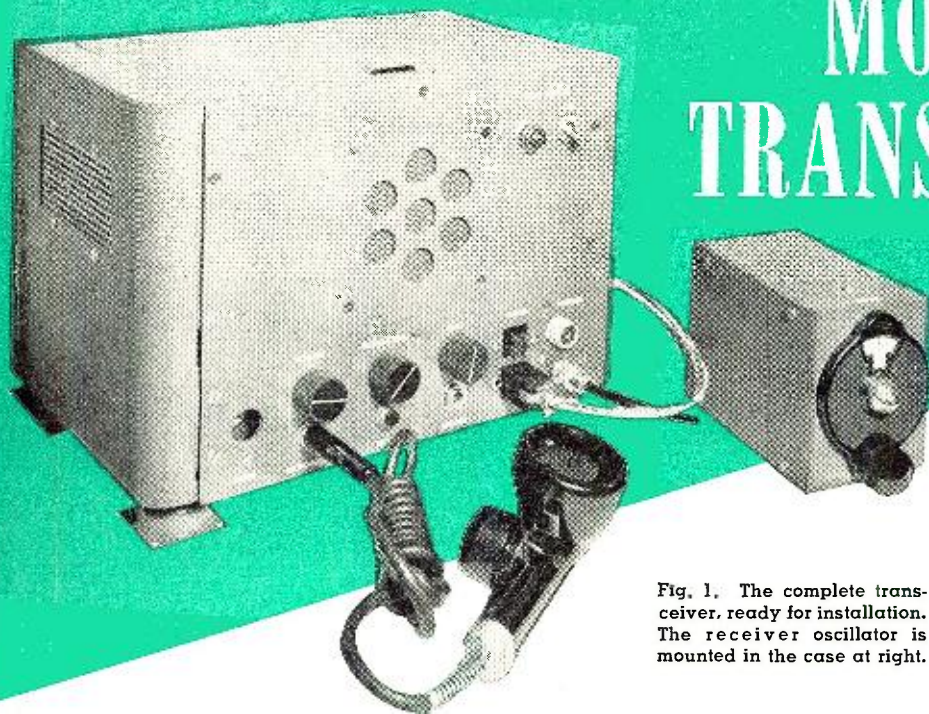

Fig. 1. The complete transceiver, ready for installation. The receiver oscillator is mounted in the case at right.

By **HARRY R. HYDER,**
W3XVL

A transmitter-receiver combination featuring crystal control of the transmitter on 144 mc. band.

EVER since we acquired a car, the urge to "Go Mobile" has become more and more insistent. Within a short time (about two days!), we had reached the point where we were convinced that life would be empty and unbearable without a rig in the car. Obviously, something had to be done. But—which band? What kind of a rig? How much power? What about the receiver? All these questions had to be answered. The question of which band was most easily answered. The thought of battling the QRM on ten meters with a few watts and a whip antenna was anything but appealing. Six meters, in this area, is not very thickly populated. The 144 mc. band seemed the logical choice for the following reasons: In urban areas, there are usually a number of stations on the air every night, the QRM problem is not severe, high power is not needed for local QSO's, and several of our friends had mobile rigs which they operated with great success.

Since the ampere-hour capacity of an automobile battery is slightly less than the local power lines, power drain is a prime consideration. We toyed with the idea of installing a surplus PE-103 dynamotor—until we heard

that the thing drew 21 amps! Then we remembered that the car's broadcast set had a power supply capable of giving 275 volts at 100 mils and drew only 10 amps from the battery, including filaments. If we could utilize this, our power problem would be solved. But would this be enough? More of that later. Investigating the radio, we found that it was a very easy matter to install a d.p.d.t. toggle switch on the broadcast set, transferring "B plus" and filament voltage from the set to the two-meter rig. We had our power supply.

This left the rest of the rig to be designed. Now, anyone going on two meters with a modulated oscillator and radiating superregenerator is going to be as unpopular as the young man in the Lifebuoy ads; so nothing less than crystal control and a superhet receiver were considered. At first, we were rather doubtful of our ability to design a crystal-controlled transmitter with modulator, yet keep the battery drain down to 100 ma., but with judicious allocation of the precious milliamperes the job was done.

The receiver portion is shown in Fig. 2. It was decided to make the receiver audio do double duty as a modulator in

order to save space, another very important factor, and filament drain. The voltage amplifier is one-half of a miniature 12AT7 (the other half has a peculiar function and will be described later), and the power amplifier is a 6AQ5, which is our old friend the 6V6 in miniature. The modulation transformer system is interesting: it consists of two ordinary plate-to-voice coil output transformers, T_2 and T_3 , connected "back to back." This scheme was described in detail by the writer on page 51 of the January 1946 "QST," and was peculiarly suited to our application, since a s.p.d.t. section of the push-to-talk relay, RL_1 , connects the secondary of the first transformer directly to the voice coil of the speaker on receive, and to the other transformer on transmit, where the audio voltage is stepped up again and used to modulate the Class C amplifier. The efficiency of each of these transformers was measured to be slightly over 80 per-cent, so there is a small loss of audio power over a single modulation transformer, but since three watts of audio will completely modulate the transmitter, and the 6AQ5 can put out almost five watts, this was not considered important. The audio system turned out to have much more gain than necessary (the 12AT7 has a μ of 55), so some of it was thrown away on inverse feedback, cleaning up the distortion considerably and making the matching less critical. The audio range was purposely limited to 300-3000 cycles by using low-capacity coupling condensers and rather high audio plate bypass condensers. The audio input transformer is one of the familiar microphone and single plate-to-grid transformers, made by most transformer companies expressly for this purpose. The single button carbon mike gets its voltage from the 6AQ5 cathode circuit, through an R-C filter. Two 105 volt voltage regulator tubes, miniature OB2's, are included to stabilize the voltage on the modulator screen, crystal oscillator plate, and local oscillator plate.

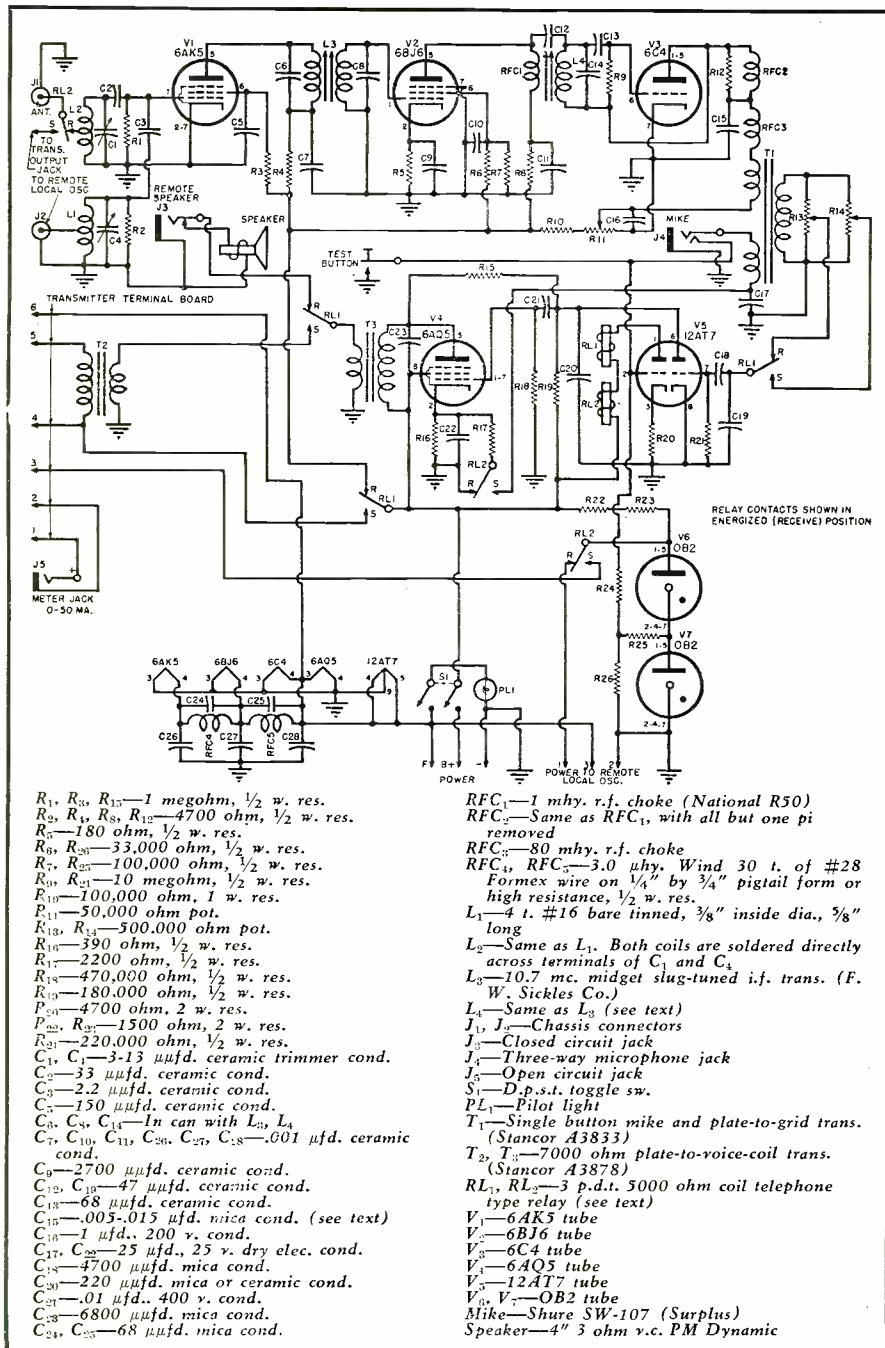

Fig. 2. Diagram of receiver and modulator. The receiver oscillator is separate.

The transmitter section shown in Fig. 5 posed quite a problem, until we heard of 48 mc. crystals. This reduced our requirements to an oscillator, a single tripler, and a final amplifier. It was decided to use triodes all the way through, since there are a number of types which operate efficiently at v.h.f. Both the 12AU7 and 12AT7 were considered, but their basing did not lend themselves to push-pull amplifier operation. This left the 6J6 and the 7F8; the latter was chosen because of its large base, which would permit better parts placement. The *Western Electric* 2C51 could also be used, but it is expensive and not readily available. One 7F8 is used as an oscillator-tripler, and the second, as a push-pull Class C amplifier. The oscillator circuit is

conventional, except for the inductance in series with the crystal. This circuit is recommended by the crystal manufacturer and should give no trouble, as long as the oscillator plate voltage is held down to 150 volts. The tripler is likewise conventional. Both stages are tuned by 3-plate midset air trimmers, with the coils soldered directly to the condenser terminals. The tripler grid is tapped down half way on the oscillator tank circuit, L_2 . The amplifier is inductively coupled to the tripler, and the two leads from the amplifier grid coil, L_1 , are "crossed over," to permit easier mounting of the two neutralizing condensers, C_6, C_7 , which are both 1.5-7 μ fd. ceramic trimmers. The amplifier plate tuning condenser, C_8 , is a three-plate "butterfly," with $\frac{3}{8}$ " wide

brass strips soldered to each stator assembly. These strips have low inductance, giving good tank circuit efficiency. The tank coil, L_5 , is mounted at one end of the strips and the other ends go to the tube plate terminals. The output link, L_6 , includes a 3-30 μ fd. air trimmer, for adjustment of load coupling. The transmitter is built as a sub-assembly for easier construction and servicing and may be removed quite easily. Power connections are made to a terminal board on the inner-rear drop of the chassis. The transmitter output goes to a midset coax jack, J_1 . A 6-inch length of RG53U coax, fitted with a plug, comes from the antenna change-over relay on the main chassis to this jack. It can readily be seen that the transmitter is really an independent unit, and can be removed and used as a driver for an 832 or 829 at the home station. The measured power output of the coax fitting turned out to be 3.1 good, healthy, r.f. watts, and the total "B" drain on transmit, including modulator, was 95 ma. Success!

The Receiver

This was a different sort of problem. Power drain would naturally be lower, but sensitivity and selectivity were prime considerations. Any form of superregenerative detector operating at 144 mc. was rejected, since its selectivity would not be adequate. But a straight superhet would require too many tubes and tuned circuits to give adequate gain. So we compromised on the familiar superregenerative superhet, with one stage of i.f. operating at 10.7 mc. The measured selectivity of the receiver is less than 200 kc. at 10 times down, which is good enough for the present state of the band and yet does not require extremely fine tuning, which would be impractical in mobile work. The measured sensitivity is 1.5 microvolts for 10 db. (power) of quieting; and the leakage from a *Ferris* 18C signal generator, a fraction of a microvolt, can be heard distinctly. The circuit is conventional except for one thing; and that is that the receiver is tuned remotely, by the small unit seen to the right of the rig in the photograph. What does this unit contain? Nothing but the receiver's local oscillator! Our reasoning went something like this: tuning must be done from the driver's seat. Yet, the whole rig could not be installed there, since there was not room enough. How about a remote r.f. head mounted on the steering column with the rest of the rig in the trunk or behind the rear seat? Better, but there were too many cables going around. Then the idea hit us like the proverbial ton of bricks. Why not mount the local oscillator on the steering column and pipe it to the rest of the rig, wherever that might be, through a hunk of coax? A 6C4 as an oscillator can put out a couple of watts, and even allowing for a great deal of attenuation in the coax, enough should be left at the receiver

for efficient conversion. And since only one r.f. tuned circuit was contemplated in the receiver proper, this could be permanently tuned to 146 mc., and the loss in gain at 144 and 148 mc. would be negligible. This remote-oscillator system was tried and worked perfectly. As an experiment, a 100 foot coil of RG58U coax was connected between the oscillator and the rest of the receiver. No decrease in sensitivity was noted. The oscillator circuit shown in Fig. 7 is conventional, except that a hairpin tank circuit made of $\frac{1}{8}$ " outside diameter copper tubing is used. A 3-13 $\mu\text{fd.}$ ceramic trimmer condenser is used as a band setter and a two-plate condenser is used for tuning. The hairpin has a right-angle bend to get it to fit into the case. The oscillator is coupled to the coax line by another, smaller hairpin. The coupling is adjustable by bending the smaller hairpin. Getting to the receiver proper, shown in Fig. 2, the mixer is a 6AK5, with grid-leak bias. The first i.f. transformer is a midget slug-tuned 10.7 mc. unit, originally intended for FM set use. The i.f. amplifier is a 6BJ6, which has a 150 ma. filament and lower grid-plate capacitance than a 6AK5. This is important, since the gain of this stage is rather high. A 6AK5 was first tried, but did not give as much gain before oscillation set in. The 6BJ6 plate load is a 1 mhy. r.f. choke, and it is capacitively coupled to the 6C4 superregenerative detector. The detector coil is a unit similar to the first i.f. transformer, with one winding removed. It is not really necessary to remove the other winding, as long as it is tuned quite far from 10.7 mc. The detector circuit is conventional and superregenerates smoothly with 25 volts on the plate. It pays to experiment with the value of C_{15} (Fig. 2), since this has a great effect on the detector operation. The optimum value will fall between .005 and .015 $\mu\text{fd.}$, and the smallest value consistent with smooth operation should be used. The one used in this unit is .0068 $\mu\text{fd.}$

Push-to-Talk Circuit

Push-to-talk is a necessity in mobile operation. At the home station this could be done quite simply with a single relay, but in this rig numerous circuits had to be switched to accomplish changeover. The obvious answer would be to use a couple of 6 volt d.c. relays operated by the push-to-talk button on the microphone. To this there was only one drawback—it was also desired to operate the rig at fixed locations from a 110 volt, 60 cycle power supply. And relays which operate from either a.c. or d.c. of the same voltage are not to be had. Then one day, while looking over the surplus counter at the local radio store, we came across some high-resistance telephone-type relays. These had 5000 ohm coils and closed on about 10 ma. We were struck with the idea of running them off "B plus." This had two disadvantages: first, it put the full "B

plus" voltage across the push-to-talk switch when open and also robbed us of 10 ma. of our precious "B" current. The latter was most important in transmit position, since on receive the total "B" drain was only about 65 ma. We solved this by having the relays energized in the receive position rather than in transmit. The first problem was solved by using the other section of the 12AT7 audio amplifier to control the relays. Here is the way it works: the two relays (two had to be used, since not enough contacts were available on one) are connected in series in the plate circuit of the control tube. A high resistance, R_{20} , is placed in the cathode, and ordinarily the tube would be close to cut off and the relays not energized. But a positive voltage, about 25 volts, obtained from a high-resistance voltage divider, R_{25} , R_{26} , across one of the voltage regulator tubes, is applied to the grid of the control tube, counteracting the cathode bias and causing the tube to draw enough current to energize the relays. This is the condition in receive position. The push-to-talk switch is connected from grid to ground. When this is pressed, the positive voltage on the grid is short-circuited to ground, the tube returns to its non-conducting state, and the relays open, switching all the circuits to transmit. This may sound very complicated and no doubt is, but it does the job. If you think you can do any better you are welcome to try. Each relay is a 3 pole, double-throw affair. One of the relays, luckily, had a set of ceramic-insulated contacts, and this was used for antenna changeover. At first it was suspected that the antenna relay would introduce considerable loss, but the actual measured loss was less than .2 watts, which is a small fraction of the 3.1 watts which the transmitter puts out.

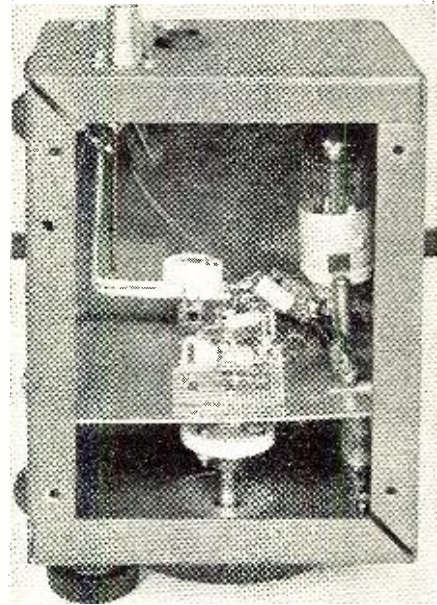
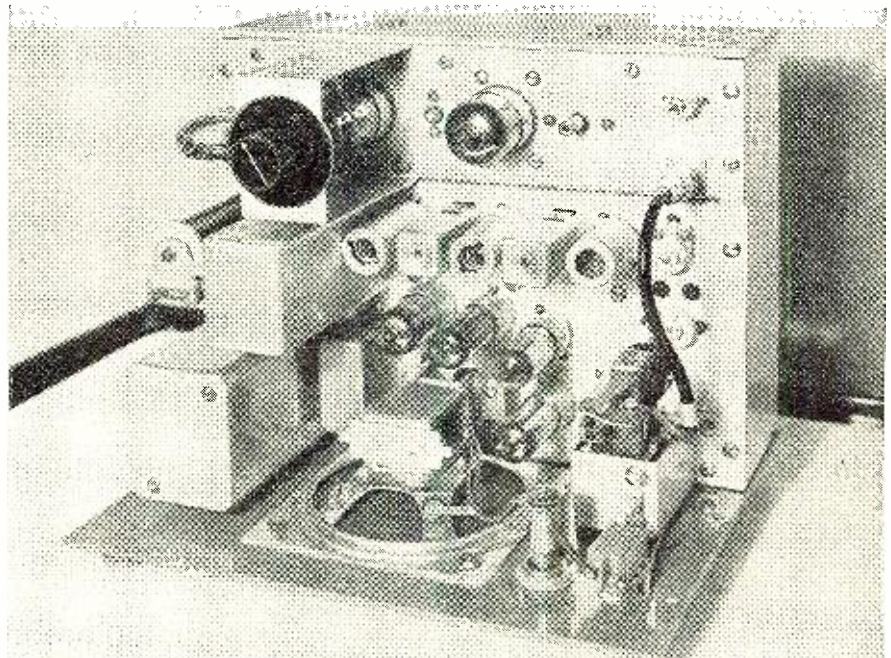

Fig. 3. Interior of receiver oscillator. See Fig. 7 for wiring diagram.

Of course, in any mobile installation, size is an important consideration. In the junkbox, we discovered an 8" x 8" x 12" metal cabinet, which had been used for some forgotten purpose in prewar days. With some misgivings, we attempted a layout in this restricted space. Happily, through the choice of midget tubes and components wherever possible, we were able to achieve a layout which included everything necessary, yet permitted easy wiring and assembly. The cabinet was fitted with four surplus Lord shockmounts, to help the rig take the inevitable jolts and jars of mobile work. The standard chassis size for this cabinet would be 7"x9"x2", but

Fig. 4. Top view of receiver and transmitter. Meter switch is mounted on a bracket.



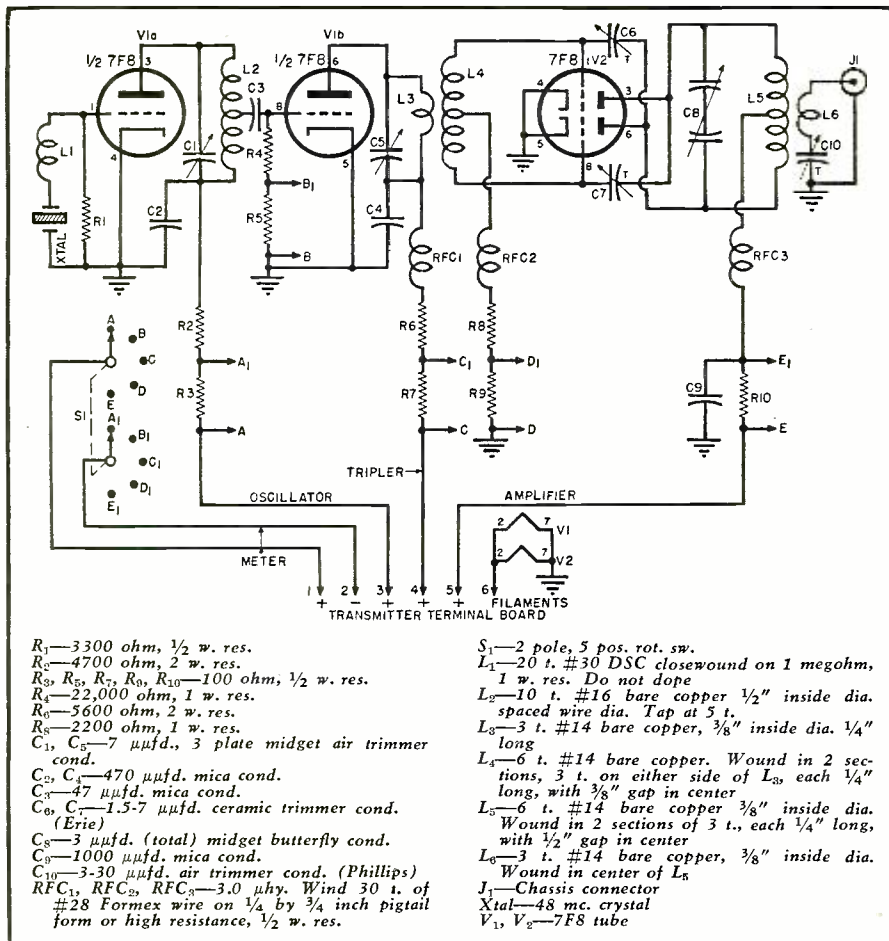
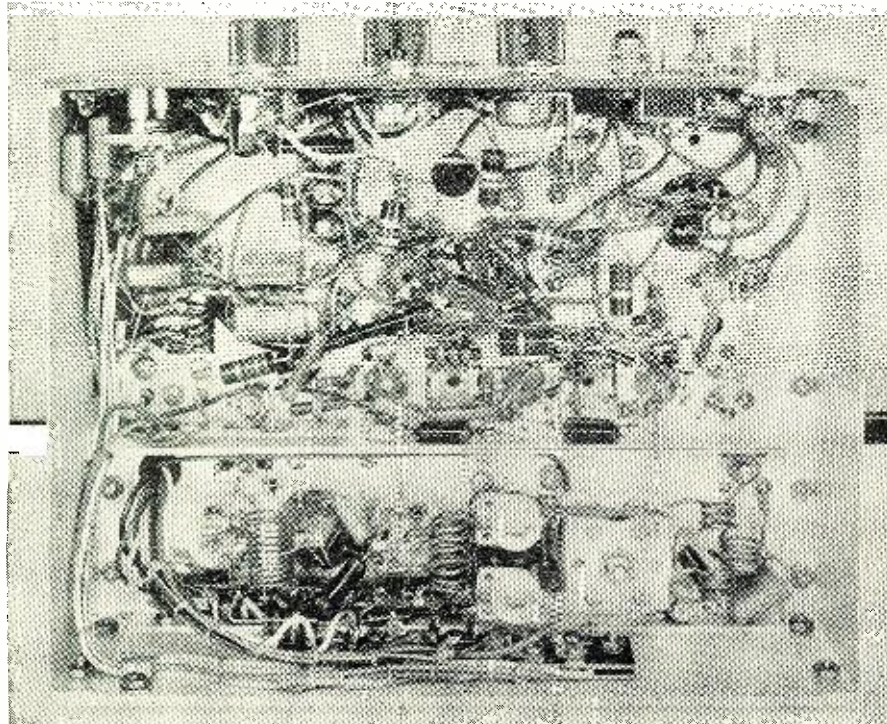

Fig. 5. The r.f. portion of the transmitter. A 48 mc. crystal is used with a tripler.

this did not seem large enough. So a chassis was bent up from .040" 52ST half-hard sheet aluminum. Aluminum is very easy to work and is a good

conductor. The construction of the chassis is apparent from the photographs. It measures 7 $\frac{3}{4}$ " deep, 10" long, and 2 $\frac{1}{2}$ " high, and was built in

Fig. 6. Underchassis view, showing r.f. portion of transmitter along bottom of photograph.



about an hour using merely a pair of shears and a vise, with a couple of short lengths of iron angle to assist in the long bends. After the mounting holes were drilled, the chassis pieces were dipped in a caustic soda solution to give the familiar "frosted" finish, and the outer surfaces only were given a coat of clear lacquer to prevent finger marks. The 8"x10" panel was made from thicker aluminum and was given two coats of gray Duco, sanding between coats. Of course, a larger standard panel and chassis may be used if the reader has qualms about sheetmetal working.

The transmitter sub-assembly is mounted at the rear of the chassis, and the receiver-modulator at the front. This may be readily seen in Fig. 4. All of the transmitter tuning adjustments are made from the top of the chassis with a screwdriver, since the necessity for changing frequency is slight, and only bloated capitalists own more than is mounted on an aluminum bracket over the oscillator-tripler tube, since one 48 mc. crystal! The meter switch is the only space which could be found for it. The meter jack is on the front panel, however, and is spaced one inch behind the panel on a strip of bakelite, since both sides of it are "hot." All of the other controls are mounted on the front panel. At the far right are the antenna jack (standard size coax), the local oscillator input jack (midget coax), the main power jack, and the oscillator power jack (both Jones type). On the upper-right corner of the panel is the "B plus" switch and pilot light. The three knobs control receiver a.f. gain, transmitter a.f. gain, and regeneration. Underneath these knobs are the microphone jack, a test push-button (in parallel with the microphone push-to-talk switch), and the remote speaker jack, which cuts out the internal speaker when a plug is inserted. The meter jack is at the far left. In order to dress up the unit slightly, the two audio output transformers were mounted in an aluminum shield can, one above the other. The audio input transformer and the 80 mhy. r.f. choke were mounted in another shield can. Needless to say, all of this lily-gilding is not necessary. The r.f. wiring is as short and direct as possible. The midget ceramic condensers used for bypassing and coupling are about the only ones that can be used in so small a space. The long audio leads from the relay to the front panel controls and tubes are shielded and covered with spaghetti. The leads from the antenna and oscillator jacks to the relay and tuned circuits are 75 ohm twin-lead, and these short lengths cause no loss due to the slight mismatch. The external local oscillator is built in a standard 3"x4"x5" steel can, designed to be mounted on the steering column of the car. Its construction is fairly obvious from the photograph. An aluminum wall is placed about 1 $\frac{1}{2}$ "

(Continued on page 104)



International SHORT-WAVE



Compiled by **KENNETH R. BOORD**

WE ARE pleased to dedicate the *ISW Department* this month to the Swiss Short-wave Service. Here is current information just received direct from Russell Henderson of the Berne staff:

The Swiss Short-wave Service's summer program for 1949 includes several new transmissions. There are now three transmissions in *English* daily to the United States; two daily to Australia, New Zealand, and the Far East; and the daily broadcast to the United Kingdom and *Eire* has been considerably enlarged. Switzerland now calls the Orient with three complete transmissions a day: the first beamed to Southeast Asia, the second to India and Pakistan, and the third to the Middle East. The services for Spain, Portugal, and Latin America have been enlarged, while the program for Europe is now more varied and is broadcast between 0020-1700. This program is also beamed to Africa three times daily.

All transmissions give news and news commentary features for information of listeners abroad. "The Swiss Viewpoint" is given on home and foreign affairs, cultural matters, and economy. Nightly, there is a survey of the Swiss press, while the feature, "Towards A Better World," (under which title the more constructive aspects of the rebuilding of Europe was treated) has been retained. From now on, SBC's correspondents in England, Germany, Italy, and France will present weekly reports on the situation in the countries surrounding this tiny democracy in the heart of Europe.

The "Swiss Curiosity Shop" is once again a nightly session. In it, the programs "Among Us Girls," "We Recorded It For You," "You Asked For It," and "The Music Box of Lucas" have been kept, while new highlights are evenings with the studio orchestra conducted by Paul Burkhard (a program of light music) and "The Shopkeepers" (an amusing program of the off-the-microphone activities of the Swiss Curiosity Shopkeepers). Sunday night's feature is now "Switzerland at Work and Play," a program in the form of a weekly documentary on life

in Switzerland, its industries, its sports, its government, and the daily cares and joys that make up living in Switzerland.

The popular hour-long programs for Swiss abroad, full of the delightful Swiss folk music enjoyed by everyone, are still highlights of the summer program. There is the "Soiree Romande" for French-speaking Swiss abroad, "Serata Ticinese" for Italian-speaking, and the "Schwyzerdutsche Heimetobig" for the dialect-speaking Swiss overseas.

The request program, "Dancing in Switzerland," is more popular than ever, while the "Sunday Evening Concert" and the weekly "Symphony Hour" present music played in Switzerland to the world. "Music by Swiss Composers" and "Swiss Folk Music" are presented once a week.

These detailed program hours have been made possible by the installation of three 100 kw. and two 25 kw. transmitters at SBC's transmitting center at Schwarzenburg, near Berne. Switzerland now calls the world 24 hours a day on HER3, 6.165; HER4, 9.535; HER6, 15.305; HER7, 17.784; HER5, 11.865; HE15, 11.715; HED7, 15.120; and HEU3, 9.665. Further program details are in the program schedule which is available free on request to the Swiss Short-wave Service, Neuen-gasse 28, Berne, Switzerland.

Through the courtesy of Art Hankins, Pa., here are complete summer schedules of the Swiss Short-wave Service:

To North America—First transmission 1730-1815, 11.865, 15.305, 17.784; second transmission 2030-2215, third

transmission 2215-2300, 15.305, 11.865, 9.535.

To Australia, New Zealand, and the Far East—First transmission 0215-0400, 11.715, 11.865, 15.305; second transmission 0400-0445, same channels.

To United Kingdom and *Eire*—1345-1530, 9.665, 11.865.

To Southeast Asia—0745-0930, 15.120, 15.305, 17.784.

To the Middle East—1145-1330, 15.120, 11.865.

To Spain and Portugal—1545-1600 (Portuguese), 1600-1715 (Spanish), 11.865, 15.120.

To Latin America—1830-2000 (1830-1845 Portuguese, remainder in Spanish), 11.865, 9.535, 15.305.

To Europe—0020-1700, 6.165, 9.535.

To Africa—0120-0240, 15.305; 0500-0730, 17.784; 1030-1700, 15.305. (This is relayed from the European Service.)

Our best wishes go to the Swiss Short-wave Service in Berne, with congratulations on the fine quality and the expansion of transmissions!

* * *

Latin in English

We are delighted that some of the Latin American stations have expanded services to include international programs in various languages, including *English*.

Radio Nacional, PRL-8, 11.72, Rio de Janeiro, Brazil has started a series of broadcasts in *English*, directed to the United States, Monday through Friday at 2130-2145 (may be expanded by this time). News, commentaries, and music are included. Whether or not this series will continue depends on response from U. S. listeners, station officials announced. (First reported to me by Gaynor, Calif.)

Buenos Aires, Argentina, is now using *English*, Spanish, French, Italian, and Portuguese for its international service. Hans Leven, Brazil, airmailed this official Argentinian statement:

"Stations *Belgrano*, *El Mundo*, and *Splendide* have inaugurated an international broadcasting service directed to the peoples of Spanish, *English*, French, Italian, and Portuguese languages with the purpose of diffusing in other countries those things which refer to Argentine life, customs, history, work, progress, ideals, and arts." Official name of this new service is

(Continued on page 98)

William S. "Bill" Fargo, Augusta, Ga., a regular contributor to ISW, shown at the controls of his super-pro receiver. Instrument at right is a pre-selector.



(Note: Unless otherwise indicated, all time is expressed in American EST; add 5 hours for GCT. "News" refers to newscasts in the English language. In order to avoid confusion, the 24 hour clock has been used in designating the times of broadcasts. The hours from midnight until noon are shown as 0000 to 1200 while from 1 p.m. to midnight are shown as 1300 to 2400.)

DISTURBANCE TESTS— A Short-Cut in TV Servicing

By **CYRUS GLICKSTEIN**
American Radio Institute

Expensive and time-consuming test procedures can often be eliminated when these quick and easy checks are used.

They are adaptable for most types of TV sets.

ANY service companies and individuals handling TV guarantees are finding that the cost of servicing receivers becomes too high for comfort when sets must be picked up, serviced at the factory or shop, and then returned to the home, making three jobs out of one service problem. It is quite possible that, as guarantees expire, high charges for servicing, caused by high labor cost, may in time become a factor in slowing down the rate of TV expansion, at least among the lower and medium bracket income groups.

Any development that will cut down the cost of servicing, allowing the price to be brought down while still permitting a fair profit, will benefit both the consumer and the service technician, as well as the rest of the industry. Lower cost, in turn, would have to be based on (1) a higher percentage of servicing completed in the home on the first call and (2) the time devoted to servicing each set should be reduced to a minimum—the last point being no different from any kind of profitable radio servicing.

Progress on both these points will depend on the development of faster, surer, and, preferably, simpler servicing techniques, as well as on the ability to apply these techniques.

The technique of disturbance testing described below can be used in both the home and the shop and is primarily designed to find a dead or weak stage in a minimum of time.

Disturbance tests are basically the signal injection method of trouble-shooting, except that no signal generator is used. They are not a new idea. Radio service technicians have been using them for a long time to find trouble in a hurry, using a screwdriver to scratch grids and plates, shorting resistors, etc. Many TV service technicians use them in one form or another, and they are commonplace in radio and TV production line testing.

As with any tool, advantages and limitations should be understood. In the credit column, disturbance testing is a quick method of locating a dead or weak stage with the use of a minimum of equipment: a multimeter, a screwdriver, a clip lead, and a .1 condenser. It is especially handy for trouble-shooting in home calls when it is either not convenient or not possible to bring along bulky test equipment. Incidentally, in making service calls to the customer's home, it is well to get some general idea of the nature of the trouble beforehand, so a proper selection of replacement tubes can be brought along, in the event the cause of the difficulty turns out to be a bad tube.

On the debit side is the point that it is not a good method for finding such faults as distorted output, mistuning, and similar troubles. Also, it may not give too definite an indication of trouble with certain stages. However, if it is

Three representative video sets. From top to bottom: Cleervue's "Hollywood," Motorola's 7" table unit, and RCA's Model 8-T-270.

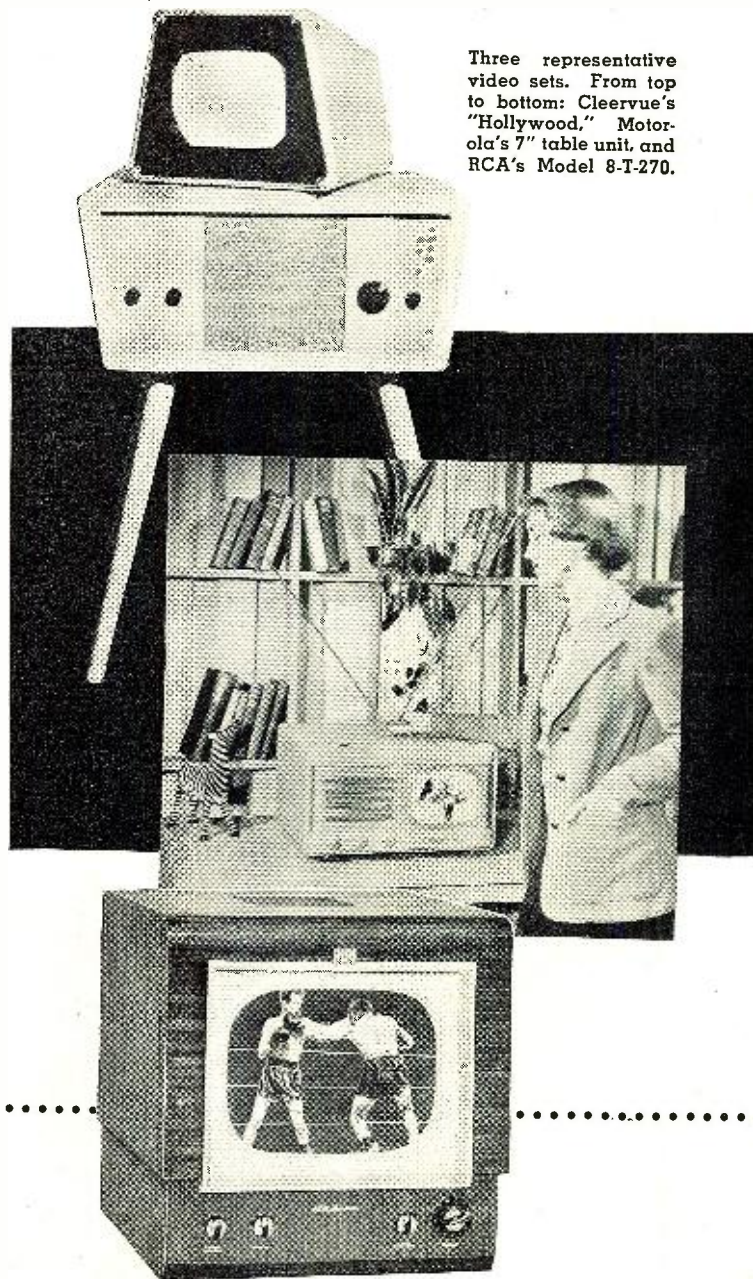



General Electric's Model 805 table model set (top) uses a 10" tube and is housed in a plastic cabinet. DuMont's "Chatham", housed in wooden cabinet, is shown in the center while G.E.'s streamlined Model 807 is shown at bottom. Trouble shooting any one of these sets can be done the "quick and easy" way by using disturbance tests method outlined herein.

understood that this is mainly a preliminary method of locating trouble, to be used only when a dead or a weak stage is indicated, and that other methods of trouble-shooting can continue where this leaves off, it will be found a valuable time-saver for the service technician. It will very often localize the defective stage in a matter of minutes, and it is then necessary only to make a tube check, or to take voltage and resistance readings to find the defective component.

To show how disturbance testing is applied to TV, suppose we start with a given type of receiver—the RCA 630, a set which is also marketed under a number of other trade names. It does not follow that every test here will apply to any receiver, although most of them will. By a little experimentation on a functioning set of a given type, the service technician can compile information that will be very useful for servicing such receivers later on. One caution might be suggested. Where there is any doubt that a particular disturbance test will definitely show whether that stage is operating or not, try it twice on a good set—once with the tube in and once with the tube out. Naturally, there should be a noticeable enough difference in action to make the test valid.

The general divisions of the receiver we are subjecting to test are:

1. High-voltage supply (including CRT)
2. Sweep circuits
3. Low-voltage supply
4. Audio strip (including i.f.'s)
5. Video strip (including i.f.'s)
6. Front end

In making a preliminary analysis of the receiver, we find the set uses a fly-back type of high-voltage system. This depends on the fast collapse of the lines of force of the horizontal saw-tooth in the horizontal output transformer, inducing a high voltage in one of the windings. The product is then rectified, filtered, and fed to the internal aquadag coating of the CRT.

Let us assume the first trouble is that no spot appears on the screen when the set is turned on, and the brilliance control is maximum; sound is coming through. This may be due to three general causes.

1. Failure of the high-voltage system: transformer, rectifier, filter, etc. Of course, without high voltage to pull the beam of electrons to the screen, no spot can appear.

2. Failure of the horizontal saw-tooth. If no saw-tooth comes to the horizontal output transformer, we do not merely lose horizontal deflection, but no spot can appear since no high voltage will be generated.

3. Failure of the CRT—including correct voltages on its electrodes. This would include an open filament, grid biased to cut-off, incorrect placement of bending coil, etc.

Disturbance tests, as in all planned trouble-shooting, will proceed to rule out or localize the main possibilities. The first step is to note if the CRT filament is lit. If so, the set is turned off, and the high-voltage cap is taken off the CRT. The set is turned on again, and a quick check is made to determine if high voltage is available to the CRT.

Test One: The high-voltage cap is held at the rubber base with one hand, and the cap is brought close to its connection point on the CRT. If there is a thin and continuous arc as it is held about a quarter inch from this point, we can assume we have high voltage.

Before any brick-bats start flying, the author would like to indicate he is well aware there are about 9000 volts on the spring contact inside the rubber cap. However, the cap is adequate insulation, the test has been made innumerable times, in fact, is almost standard in production testing, and there is no danger of shock if reasonable care is exercised in holding the cap. It might also be mentioned that even in the case of direct body contact with the spring in the cap, the filter series resistance (one megohm) as well as the small charge stored by the low filter capacity would bring the total current that could possibly flow through the body to far less than the 150 ma. necessary for a dangerous shock and even less than the 20 ma. required for an uncomfortable shock. (Fink: "Principles of Television Engineering," p. 363) However, this is not to be considered as an invitation to test the

Fig. 1. Circuit diagram of RCA's Model 630TS 10-inch television receiver. This circuit is used to illustrate the author's principle of trouble-shooting by disturbance test techniques. The principles as covered in the text can be applied with equal success in servicing any television set.

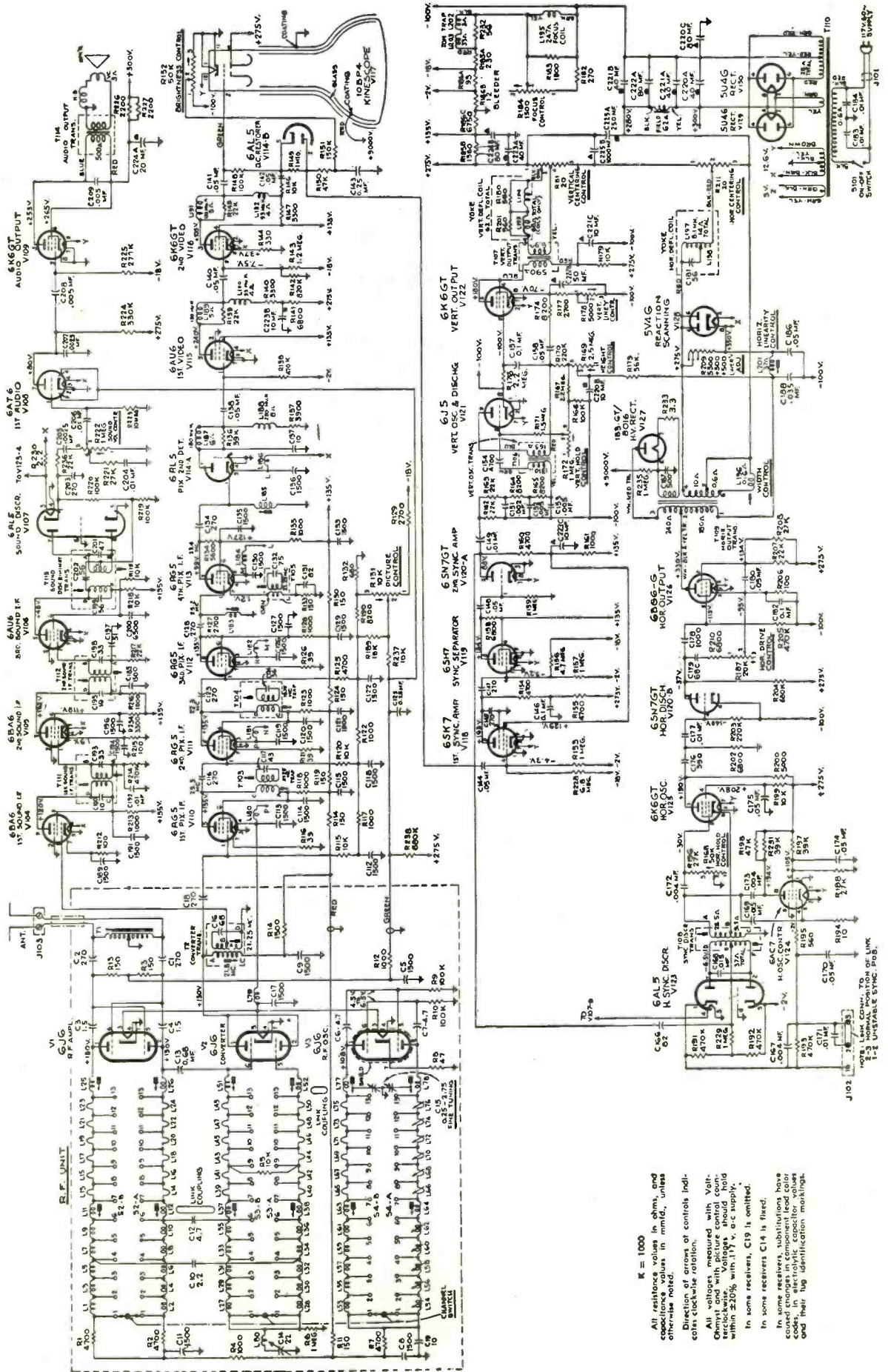

K = 1000
 All resistance values in ohms, and capacitance values in mmfd., unless otherwise noted.
 Direction of arrows of controls indicate clockwise rotation.
 All voltages measured with Volt-Ohm-mill and with picture control knob within 220% with 117 v. a-c supply.
 In some receivers, C19 is omitted.
 In some receivers C14 is fitted.
 In some receivers, substitutions have been made in the picture control circuit and their leg identification markings.

accuracy of Mr. Fink's allegations, since it is always possible for *R* and *C* values to change under operating conditions.

If we have the arc, then, at the CRT high voltage connection point, we assume we have "B+" for the picture tube. To check further why there is no spot, we verify the voltages at the tube socket. This is done by simply removing the socket from the tube and a voltmeter reading taken from each socket pin to ground and compared with indicated voltages on the schematic. This may show up the reason for non-functioning of the CRT—biased to cut-off, no screen grid voltage, etc. If these voltages are O.K. then the last factor to be checked would be the bending coil or magnet, which acts as the ion trap. If this is far enough out of position, no spot appears on the screen.

At any rate, a quick high-voltage check at the cap as indicated in Test One tells us the next point to look for trouble. Suppose we do not have the arc. Then we assume the trouble is either in the high-voltage system or in the horizontal saw-tooth stages.

There are other quick disturbance checks to localize the trouble. The high-voltage cage is opened. This automatically breaks the circuit because of the interlock connected to the cage. A patch-cord or even an electric shaver line cord can be plugged in. Obviously, since there is high voltage here, caution should be exercised. A screwdriver with a heavy wooden or plastic handle is used for the next test.

Test Two: The blade of the screwdriver is touched to the plate cap of the 1B3 (8016) (Fig. 1) high voltage rectifier tube and slowly lifted. If a.c. of high enough voltage is coming to the plate of the rectifier, an arc will be drawn off for about $\frac{3}{4}$ "—in other words, there will be a thin, steady arc between the cap and the screwdriver blade which is held close to but not directly on the cap. Obviously, if we get the arc here but not at the high voltage cap in our first test, the trouble lies between these two points. A resistance check should show up the trouble. There are only a few parts to be checked—the 1B3, filter condenser C187, filter resistor R235, continuity to high voltage cap, 1B3 filament winding continuity and placement, etc.

Test Three: If no arc is found here the trouble is ahead of this stage, and the blade of the screwdriver is rested on the 6BG6 plate cap and lifted slowly several times. Here, too, an arc should be drawn off if the saw-tooth is present here. If it is here and not at the 1B3 plate, the trouble is between these two points (transformer continuity from Point 2 to 3 on schematic).

On the other hand, if no arc appears on the plate of the output tube, 6BG6, we proceed to the grid of the 6BG6 to find out if the saw-tooth is coming in.

In other words, we have verified that there is no d.c. output from the high-voltage supply (Test One) and no high-voltage a.c. input (Tests Two and Three), and the next step is to check whether we have a saw-tooth input to the 6BG6. For this test, we use a .1 condenser and a test lead with alligator clips at both ends. One clip is attached to Pin 1, grid of the 6AT6, first audio stage. The other end of the lead is clipped to the condenser. The condenser is held like a probe, and the unattached pigtail is applied to various points of the circuit in the next series of tests.

Test Four: The condenser lead is applied to the grid of the 6BG6. The object is to check for the horizontal saw-tooth by sound—to use our sound stages as a signal tracer, since 15,750~ is an audio frequency, or at least just above the audio range. The horizontal hold control should be varied, and as it is rotated a shrill whistle varying in pitch will be heard. Part of the range of the hold control will probably be inaudible, since it will be above the hearing range of most listeners.

This, of course, assumes: (a) the audio circuit is working (for audio checks, see below), (b) the horizontal saw-tooth is reaching the grid, and (c) the antenna is disconnected from the set, or the channel selector is on an unused frequency so no signal will be coming in to lock in the horizontal saw-tooth at 15,750~. If the saw-tooth is present on the output tube grid and not on the plate, trouble with the 6BG6 or its circuit is naturally suspected, and a further check should be made here. On the other hand, if nothing is heard, we assume there is no saw-tooth, and the condenser probe is moved (while leaving the other end of the clip lead still attached to the first audio grid), to the plate of the 6SN7, V120B, horizontal discharge tube, grid of the same stage, and then the plate of the horizontal oscillator, 6K6, V125. If we have heard no saw-tooth while rotating the horizontal hold control at each step, then the oscillator (*Continued on page 116*)

Zenith's Model 28T960E, 12" giant-size circular screen and Hoffman's Model 902, 16" metal tube TV sets.



Admiral's "Credenze" direct-view television radio-phono combination and Garod's 15" console Model 15TZ9 television-radio combination, featuring "Tele-Zoom" control.



The transmitter and receiver combination in the background is almost obscured by the accessories needed for efficient operation of the ham station. Resting on the transmitter: a DX log and official country and prefix list and a good clock. In the foreground: plenty of scrap paper for copying and the tools, pen and pencil; the log book; and the amateur call book, the "telephone directory" of the air.

By
ROBERT HERTZBERG, W2DJJ

**Part 6. Learn to be a good
c.w. operator—it will save
you later embarrassment.**

You can get out all over the world with your modest receiver and peashooter transmitter if you stick with 'em and learn to twist the dials and punch the key properly. There's an old adage in the ham game: *You can't work 'em if you don't hear 'em.* A regenerative receiver of the type described in the April, 1949, issue of **RADIO & TELEVISION NEWS** is capable of developing terrific sensitivity, but you can obtain it only by very careful adjustment of the regeneration control. After a little experience, you'll be able to tell just how far to advance it for best reception of weak signals, and then you'll be surprised at what rolls in. Do you dare call that Australian or British station? What can you lose?

The quickest way to build up an impressive collection of QSL cards is to send clearly and perhaps a bit slowly and to send complete, intelligible words and sentences instead of the weird and incomprehensible abbreviations of which many hams are unduly fond. What's the point of sending inaccurately at the rate of 20 words-per-minute if the fellow at the other end asks you to repeat half of your transmission? You might as well have sent accurately at 10 w.p.m. the first time and at least had the satisfaction of a full acknowledgement of receipt. Furthermore, adjust your sending speed to your receiving speed, as the other fellow will send at approximately *your* sending rate. You're in ham radio to enjoy the contacts you make; you won't get any fun out of your QSO's if you can't copy what you hear. And don't be ashamed to admit it by using QRS. If you will look up this signal, you will see that it means, "Send more slowly." Very often hams will send, "Sorry OM, heavy QRM please repeat," when they really should have sent, "You're too fast for me; please slow down a bit."

A plentiful supply of scrap paper, preferably ruled, and a smoothly working fountain pen are requisites for the operating position, in addition to a log book, a copy of the Call Book, and a clock or watch. Stenographers' notebooks are ideal for copying pur-

The BEGINNING AMATEUR

THE long history of amateur radio is full of instances of sensational DX operation accomplished with extremely simple and inexpensive equipment, very much along the lines of the receiver and the transmitter described in Parts 3 (April) and 5 (June) of this series, appearing in **RADIO & TELEVISION NEWS**. There are also many notable cases of completely unhappy experiences with the fanciest and most costly equipment the market has had to offer. What makes the difference? It sounds sort of obvious to say, "The operator, of course," but the statement deserves consideration because the personal element in ham radio is often swallowed up in the attention that is concentrated on new circuits, higher power, bigger antennas, etc.

What makes a *good* operator? The

same qualities that make a good automobile driver or a good golfer: patience, carefulness, consideration for the other guy, and proper maintenance and operation of the available machine, clubs, or transmitter, as the case may be. Your car might be a pre-war heap with worn rubber and an asthmatic engine, but if you drive it carefully, feed it good fuel and lubricant, and keep out of the way of the trucks and buses, you will reach your favorite beach or fishing spot and have just as much fun as the butcher's boy who roars up in a red convertible. Sure, you'll look at the latter and say, "Now there's a buggy I'd like to whip around in," but after you learn what it cost, you'll go back to your crate and console yourself with, "This gets me where I want to go."

poses because the ruled lines are well separated and permit easy scribbling. A pen requires much less pushing than a pencil. Initially, write down everything of the other man's transmissions, and then decipher them . . . If you can! After a while, you will acquire the knack of copying "in your head," and you will be able to carry on long conversations without recording more than call letters, date and time of the contact, etc., in your log. And don't neglect the log. In these days of rapidly growing television service and the concurrent growth of "TVI" (television interference), real or imaginary, produced by ham transmitters, you can never tell when the FCC is likely to ask you to produce your records. Actually, a complaint of interference has to be pretty serious before the FCC acts, but if it does, and your log clearly isn't properly kept, you're in for a hot time.

In this connection, it might be well to state that you must record every transmission you make. Many hams have the mistaken notion that they are required to record only two-way contacts. This is definitely wrong. If you call a station, or CQ, and no one answers (and that does happen, you know!), you must still jot down the pertinent information.

CQ is the most useful and at the same time the most misused signal on the air. If you want to work someone, make it easy for him to identify you. A highly effective system is to send CQ three times, followed by your call three times, and to repeat the sequence for about 90 seconds. Just sending CQ over and over and over, without throwing in your call letters, will discourage rather than attract an answer.

If you hear a CQ and want to answer it, use a slightly different procedure. Remember that the other fellow is tuning around for his own call letters, so send these slowly and clearly for about a minute in an unbroken string, insert your own call three or four times after "de," and repeat the long call. A minute and a half or two minutes is plenty; if he doesn't tune you in in that time he's not hearing you at all and you're only wasting time and juice.

A contact doesn't, or at least shouldn't, end with the final sign-off signal. While you have the Call Book open in front of you, immediately address a QSL card to your new friend, filling in the date and time of the QSO. You can stamp and mail it the next day, but get it ready now. A supply of QSL cards is as important around the ham shack as any piece of equipment. They are cheap and they often are the start of wonderful friendships.

The "straight key" pictured with the transmitter in the June, 1949, issue is certainly the best for a beginner. Many old-timers will tell you it is also best for experienced operators, because with it you can make clean, unmistakable dots and dashes with comparatively little error. However, as your

(Continued on page 120)



You can copy weak signals through interference much more readily with a pair of phones than with a loudspeaker. Besides, the high-pitched dits and dahs from the latter can be most annoying to other members of the household.

AMATEUR RADIO STATION LOG

IF OPERATING AS A PORTABLE OR PORTABLE-MOBILE

INPUT POWER TO LAST STAGE _____ WATTS

FREQUENCY _____ APPROXIMATE LOCATION _____

TYPE OF EMISSION _____ TYPE OF VEHICLE OR MOBILE UNIT IN WHICH INSTALLED _____

DATE TIME	STATION CALLED	CALLED BY	STATION HEARD OR WORKED			IF QSO RESULTED			REMARKS, QTH. CHANGES FROM PREVIOUSLY RECORDED DATA, ETC.	QSL
			R	S	T	MY SIGS	R	S		

This is a standard form of log sheet for ham purposes.

★ ★

Something to show for all your work: "QSL" cards confirming two-way contact. Many are elaborate works of art, well worth putting on the wall of the ham shack.

MINNEAPOLIS 5, MINNESOTA
CITY OF LAWES
Wm A Newman, Operator
256 Irving Avenue North

WØYTT

Radio W2 DJJ
Ur first sigs 2:45-5:30 on 8 Mo Recv. NC101X Cond: GOOD
Xmtr Circuit P.P. 809'S Ant. J.Eh. ROT. Power 30 wts.
© Phils. Jul 1947

W2OLC

Howdy BOB I surely enjoyed our contact of
AUG 5 1948 at 4:00 P m EST On 10 M
Ur sigs QSA R5S ST on SX42 Recv
Xmtr: 40 P 30 wts FDP Ant
Rmtr JN X 4 Shout 1M BCNU
850QSL 73's ROY UDOLF fony
FRITZ PRINT

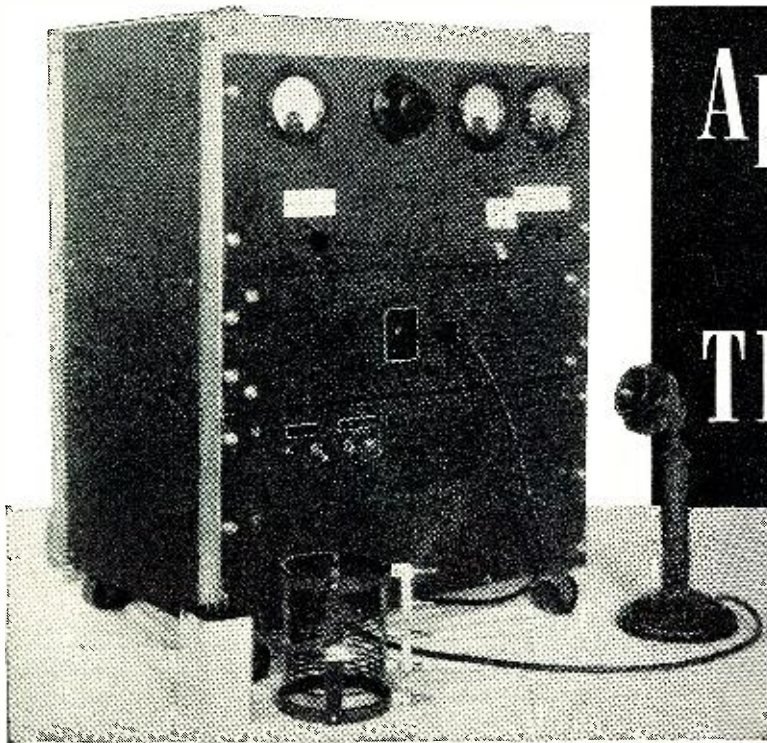

Fig. 1. Over-all view of 400-watt. c.w. phone transmitter.

By Buford Smith, W9ZMD

Self-contained in a two-foot high rack this compact, easy-to-build rig covers 10, 20, 40, 75 meter bands using plug-in type coils.

THE housing shortage has had a tremendous effect on ham radio. Many of us have only a very limited space in a trailer or small apartment in which to carry on our hobby. This means that, in many cases, we have to be content with small low-power transmitters which seldom provide contacts, or give up ham radio entirely. Here, at W9ZMD, my main interest lies in maintaining scheduled operations with friends and personal acquaintances with whom I have worked in past years. For years now, I have had to be content with the typical 807 rig. This transmitter is not to be condemned, for under some conditions it provided very enjoyable contacts, but for regular operation something more was needed.

My first attempt at higher power was to build a final amplifier and power supply to be located remotely in a garage or basement, and to be excited through a long coaxial cable from the 807 transmitter. This remote r.f. section was to be adjusted to operate Class B linear, and thus would amplify either phone or c.w. signals with no readjustment. The setup worked very well, except that it was very inconvenient to shift frequency in

a band or to change bands, a trip to the remote location being necessary for each change. Also, on one occasion, after changing frequency and forgetting to readjust the amplifier tuning, a little warning was received because of excessive harmonic radiation. Operations ceased at this time.

After this unhappy incident, I was determined more than ever to build a small transmitter to fit in the available space at the operating position, and yet be able to run at a power input of from 300 to 500 watts. In my particular case, by removing two shelves from the built-in bookcase, I could obtain a recess 27" high by 24" wide and 15" deep. In order to profit by past experience, the following points were kept in mind while designing the transmitter. As much of the rig as possible should be built with the standard hand tools available to every ham. It should incorporate simple, easy-to-adjust circuits, but should not be simplified to the extent that it would be unsafe or would not conform to good design principles. It should work on all ham bands 10 through 80-meters, and should have a minimum of controls and require a minimum of retuning when changing bands or fre-

Apartment Size 400-Watt TRANSMITTER

quency in a band. In order that the rig may be easily moved and set up at other locations, it should be completely self-contained, including all control relays, antenna changeover relay, and speech amplifier. Also, it should be possible to change quickly from phone to c.w. and from crystal to v.f.o. operation, utilizing any commercial v.f.o. Finally, because of compactness, the heat dissipation from dropping resistors, bleeders, and other components should be at a minimum.

It was hoped that a standard 26 1/4" cabinet relay rack would house the transmitter, but when the over-all height was checked in the catalogue, it was found to be too great. This relay rack would be ideal for those with somewhat more room. In my case, a cabinet had to be constructed, and it was decided to reduce the height sufficiently so that casters could be added for ease in moving. The frame was made of 1" by 1 1/2" aluminum angle from the junk yard, held together by 10-32 screws, and the sides and back were covered with 1/8" Masonite panels. A hinged aluminum top was provided in order to gain access to the r.f. deck. The cabinet has a space of 22 3/4" available for panels and this was divided up in the following manner: 8 3/4" for the radio frequency chassis, 5 1/4" for the speech amplifier and low voltage power supply, and 8 3/4" for the high voltage power supply and Class B modulator.

The r.f. section consists of three 6L6 frequency multiplier stages and a push-pull 813 final amplifier operating at 1250 volts. A single 813 could have been operated easily at the power input required but would have had to operate at, possibly, 2000 volts, and voltages of this order are somewhat high for the medium-power tubes commonly used for modulators. Furthermore, because of the previously mentioned harmonic trouble, a push-pull amplifier was wanted so as to provide cancellation of even multiples of the operating frequency. In order to keep tuning controls at a minimum, V_1 and V_2 are provided with broad-band, slug-

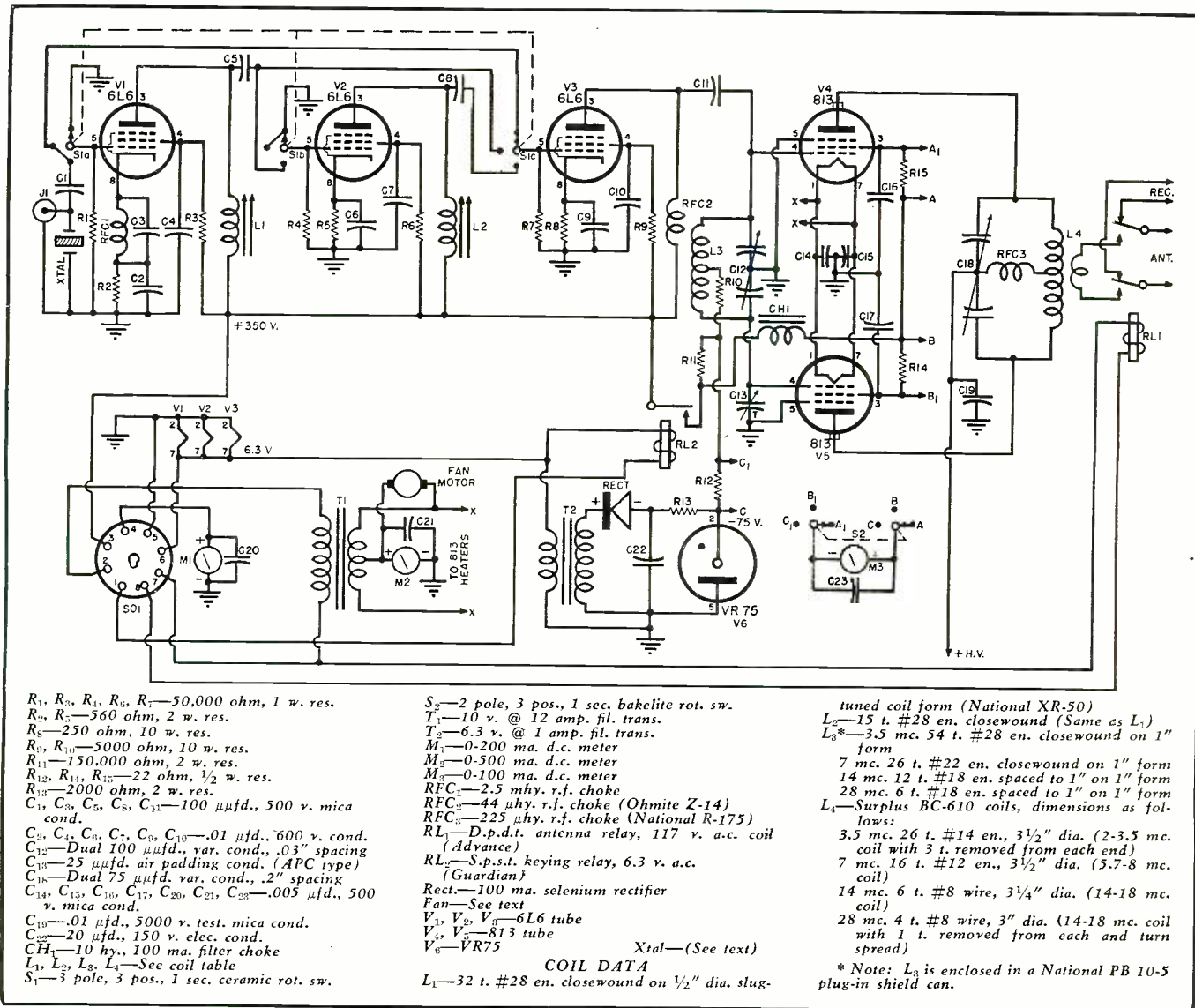

Fig. 2. Schematic diagram of the r.f. exciter and amplifier unit. Assembly details are shown in photograph below.

tuned coils. The plate circuits of V_1 and V_2 are tuned to 40 and 20 meters, respectively. The plate circuit of V_3 is tuned to the output frequency in use

at the particular time, and this tuned circuit also acts as the grid tank of the 813's.

Referring to Fig. 2, S_1 is a band-

switch, and it places one or more of the 6L6's in operation, depending on the output frequency. When changing bands the only coils to be replaced are

Fig. 3. Rear view of the modulator and high-voltage power supply (left) and the r.f. amplifier assembly (right).

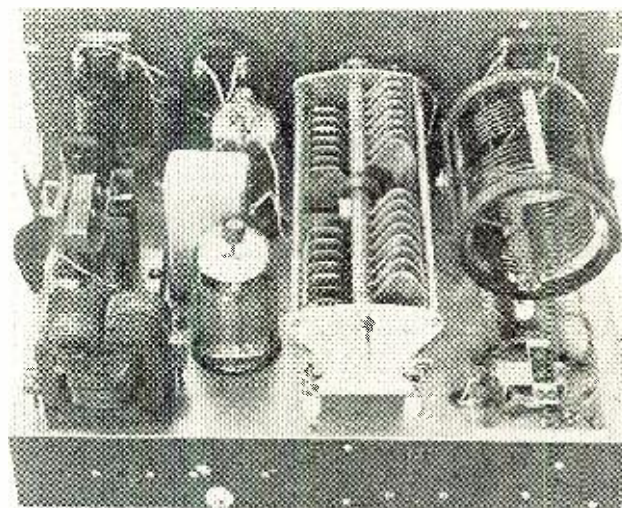
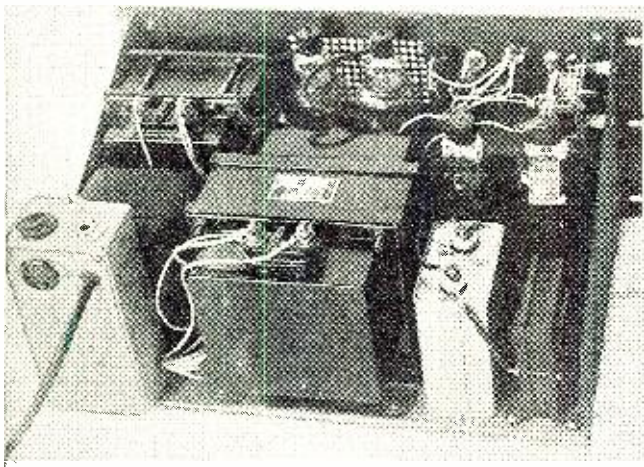

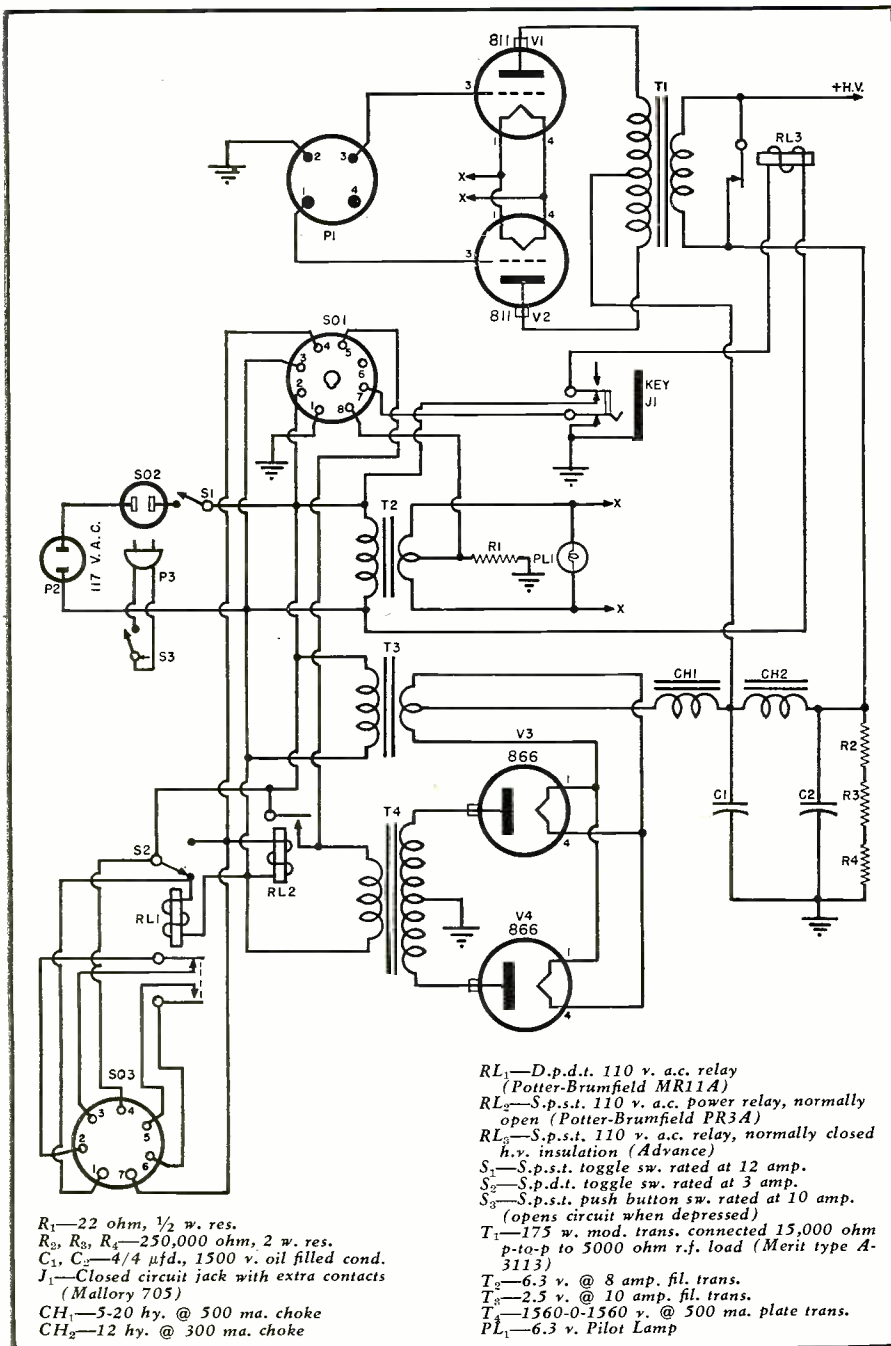

Fig. 4. Schematic diagram of high-voltage power supply and modulator unit.

those in the 813 grid and plate circuits, L_3 and L_4 , respectively. It will be noticed that no switch is provided for going from crystal control to v.f.o. operation, the change being accomplished by merely pulling out the crystal and plugging in the cable from the v.f.o. On the front panel of the r.f. section a phono jack is provided for connecting the v.f.o., and there are three crystal sockets connected in parallel in order to accept any type of present-day holder. The r.f. choke in the cathode circuit of V_1 is to provide some regeneration so that all 7 mc. crystals for either 10 or 11-meter transmitter output will oscillate properly without retuning L_4 . When V_3 is used as a crystal oscillator on 80 or 40 meters, with the transmitter output

on the crystal frequency, no regeneration is necessary since C_{12} can be tuned for satisfactory oscillation. When V_1 and V_2 are not in operation, their control grids are grounded to prevent any possibility of unwanted output. V_1 and V_2 have higher than usual values of cathode and screen dropping resistors, because high output is not required from these stages. The resistances used keep the operating and idling currents to less than 30 ma. per tube. The r.f. choke RFC_2 in the plate circuit of V_3 should be the type indicated in the parts list in order to obtain sufficient grid drive and high efficiency on 10 meters. A 2.5 mh. choke was first tried and noticeable heating resulted due to excessive losses. The particular choke recommended does not have

sufficient inductance for good 80-meter operation, but after its incorporation, the 80-meter excitation did not drop below that available on other bands, and the tuning of the 813 grid circuit was not affected.

For c.w. operation, the transmitter is keyed in the 813 screen circuit by a small high-speed relay RL_2 . This relay has a 6 volt a.c. coil which eliminates the hazard of high voltage across the key contacts. There is sufficient time delay in the keying circuit to give a clean soft note with no trace of clicks or thumps. In many cases the rig has to be operated on a.c. power lines with very poor regulation, and a method of keying, such as this, which lessens the amount of load change, is to be favored since blinking of lights is not so pronounced. A bias supply for the 813's was incorporated for two reasons. First, it prevents these tubes from drawing excessive current during intervals when excitation is absent and this feature allows quick retuning. Second, it acts as a source of negative voltage for the 813 screens (through R_{11}) during key-up intervals. Biasing the screens negatively was found necessary in order to eliminate all radiation to the antenna. The bias supply employs the recently popular arrangement of a small 6.3 volt filament transformer connected backward and a selenium rectifier.

For the modulator, type 811 tubes are ideally suited. These tubes will operate on the 1250 volt plate supply with no bias, and by overdriving somewhat and using a lower than normal value of modulation transformer plate-to-load turns ratio, they will easily modulate fully an input of 400 watts. The 813's are both plate and screen modulated; however, the screens are not connected to the modulator output but to the low-voltage power supply. The secret lies in the audio choke, CH_1 (Fig. 2) which allows the instantaneous screen voltage on the 813's to vary as the tubes are modulated. The tubes can be modulated more easily with this arrangement than when the screens are fed from the modulated plate supply through a dropping resistor. This is because the audio power loss in the dropping resistor is eliminated, and, too, the absence of this resistor removes another source of heat dissipation in the cabinet. Of course, the 813 screen bypass condensers should be only large enough for r.f. bypassing and should not be so large that audio frequencies are attenuated. The plate bypass, C_{13} , on the 813's is rather large, but this was done purposely to limit the higher audio frequencies.

The key jack is located on the main power supply panel. When the key is plugged in, an extra set of contacts on the jack breaks the circuit to relay, RL_2 , in Fig. 4, and the modulation transformer secondary is shorted automatically. The plate supply to the 811 tubes is maintained during c.w.

(Continued on page 77)

Build Your Own TV TOWER

By LYMAN E. GREENLEE

Ordinary thin-wall conduit is used to construct a triangular antenna mast up to 50 feet in height.

MARGINAL television reception requires a good antenna installation, and because it is desirable to get the antenna above surrounding objects to secure a satisfactory signal, some kind of tower is usually necessary. Several towers are now on the market, but on account of shipping and assembly difficulties, it will frequently pay to build a suitable one on the job. Building your own will be cheaper, and since the entire assembly can be welded on the job, a much stronger and better looking tower is the result.

If the antenna is located ten feet above immediately surrounding objects, good marginal reception is usually possible, and by "marginal" we mean distances of around a hundred miles from the transmitter. Going up higher with a tower will add little to the signal, and there will be some loss in the extra length of transmission line. Keeping the lead-in straight and as short as possible, with no contact against drain pipes or other metal objects, will do more to guarantee a good picture than an extra ten or twenty feet of height. Location of the tower is important, as some positions will give higher signal strength than others. If at all possible, make a temporary survey with a dipole antenna attached to a long pole which can be carried around.

If you plan to receive more than one station, some provision must be made for rotating the antenna. It can be turned by hand or with a motor. If a motor is to be used, allow for mounting it in place before the tower is up in the air, even though you do not plan to install it until later.

A directional antenna array is usually required for satisfactory marginal reception. While best results will always be secured with an array cut for the particular channel to be received, that is, of course, not always possible or convenient when more than one station is to be brought in. The usual practice is to cut an array for the middle of the band and to stack an array for the high frequencies above one cut for the low band. Sometimes it is advantageous to use an array cut to favor the weakest station to be received. Generally speaking, an antenna cut for a high frequency will be of little use in bringing in the

lower frequencies. For really marginal reception, and it is possible to pick up programs at distances of two hundred miles, it is very important to use a directional antenna cut for the particular channel to be received and properly positioned at the top of a solid tower so that it does not sway in the wind. Reception can be ruined if the antenna or lead-in is free to swing back and forth with the wind.

Before building a tower, decide on the type of array that is to be used. Weight is an important factor and will determine the type of mounting to be constructed, and this is especially true if a very heavy array is to be used. Some of the lighter antennas can be mounted directly to an antenna rotator motor, but the heavier arrays will require a thrust bearing to take part of the weight, and provision for the thrust bearing should be made before completion of the tower. A surplus or junk ball bearing out of an automobile transmission can sometimes be adapted for this purpose and if packed with heavy wheel bearing grease will give satisfactory service. A piece of tin should be shaped to fit for a cover to keep out rain and snow.

The author has made several satisfactory television towers using one-half-inch thin-wall conduit. The finished tower is very rigid and is climbable for heights up to fifty feet if properly guyed. One man can carry a completed fifty-foot section. A fifty-foot section is about the maximum practical height, unless heavier material is used and cross braces added.

The actual assembly of a tower should be easy for anyone who can do a good job of brazing. The thin-wall tubing must be handled carefully with just the right amount of heat to prevent burning and warping. All joints should be assembled with light tack welds, so that the tower can be bent and twisted back into shape to straighten it up if the sections do not fit together properly to form a perfectly straight tower. This is very important if you want the tower to look right when finished. Then all the tack welds should be carefully

(Continued on page 89)

Fig. 1. Construction details—forty feet of one-half-inch thin-wall conduit are required for each ten-foot section.

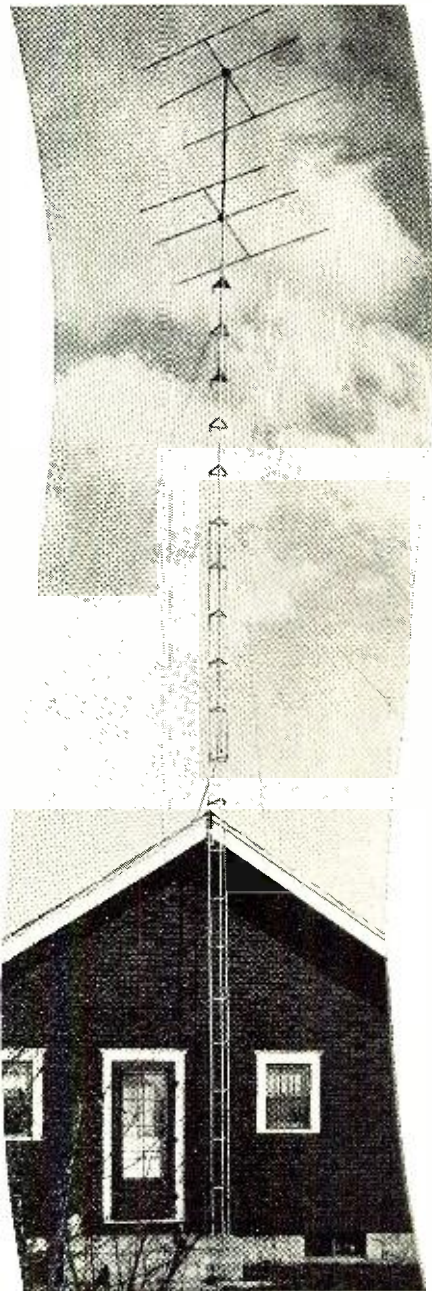

The completed tower, when properly guyed, is climbable for heights up to fifty feet.

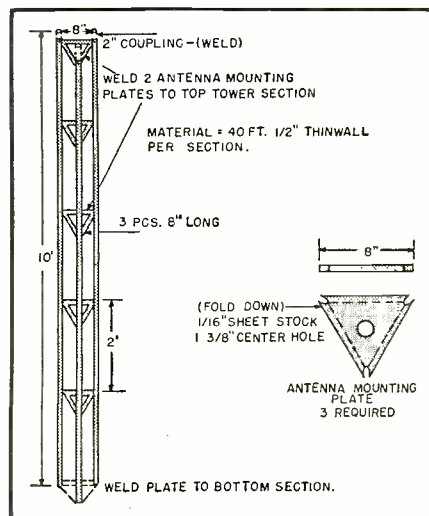

Evolution of a TV ANTENNA

Fig. 1. Test truck completely equipped to make field tests of any type TV antenna.

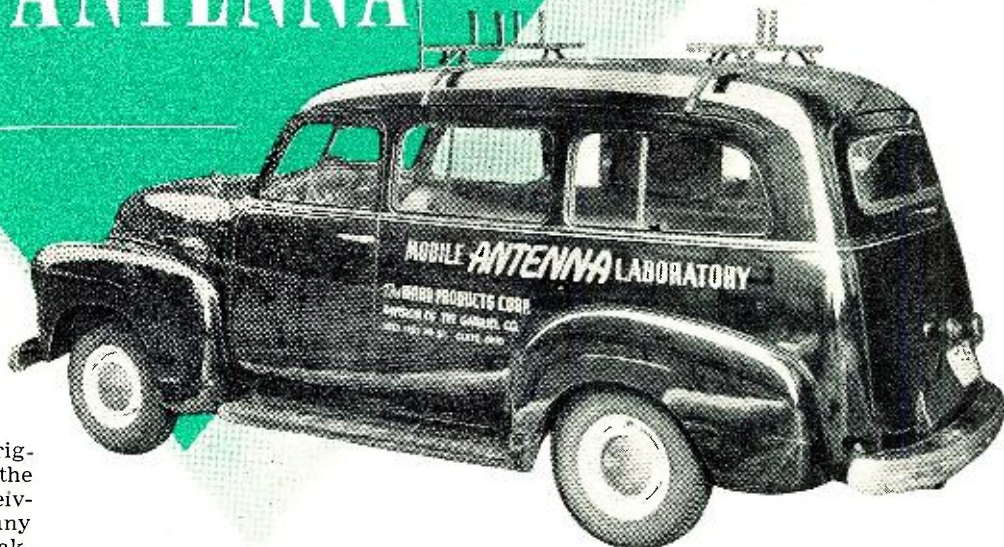

By
L. H. FINNEBURGH,
Chief Eng. Ward Products Corp.

THE television signal—from original image in the camera to the reproduced image on the receiving tube—requires the use of many types of circuits and components, taking in practically the entire field of electronics. The receiving television antenna occupies a unique position in that it is the first component handling the signal that comes under the control of the installer or service technician (and therefore the consumer!). In this position it obviously must have a tremendous effect upon the proper operation of the circuits and components which follow it—upon that part of the system which represents the major part of the consumer's investment. The antenna is therefore deserving of the best electrical and mechanical development and design.

The electrical design of a complete line of television antennas will, of necessity, have to be broken down into groups, each group being determined by the several types of antennas to be produced. Examples of the problems faced are involved in the design of a

The ultimate design of any good broadband high-low antenna can be derived only after various mechanical and electrical performance tests have been made.

high-low antenna consisting of folded dipoles only and also the high-low antenna consisting of folded dipole and reflectors, as shown in Figs. 3A and 3B, respectively. For each type, the ideal characteristics should be set up as the goal for the design. These should include such factors as uniform response of a value commensurate with the particular type of antenna, uniform horizontal plane pattern on each of the television channels to be covered, uniformly low standing wave ratio, and elimination of interaction between the

two antenna units making up the array.

The response curve, of course, must have some reference so that intelligent comparison can be made. The basic reference requires the establishment of a definite field strength at frequency f_1 and measurement of the antenna response under test at this frequency; then establishing the same field strength at frequency f_2 and again measuring the response of the antenna at frequency f_2 , etc. This test should be made for at least one frequency in each channel. A second method is to build a reference tuned and matched dipole for frequency f_1 and establish a field of satisfactory strength for this reference. The antenna to be tested is then subjected to the same field, and its response is compared to that of the test reference antenna number 1 to obtain its comparative response at frequency f_1 . Another test reference antenna, number 2, is tuned and matched for frequency f_2 and is placed in a field of sufficient strength so that it has produced at its terminals a nominal voltage. Then the antenna being tested is subjected to this field of frequency f_2 , and the terminal voltage developed in this antenna is again compared to that of test antenna number 2, thus giving the comparative response of the unit at frequency f_2 . A series of test reference antennas is required, at least one being required for each channel.

Fig. 2. Frequency response and SWR curves for Ward models TV-46 and TVHA-9 antennas.

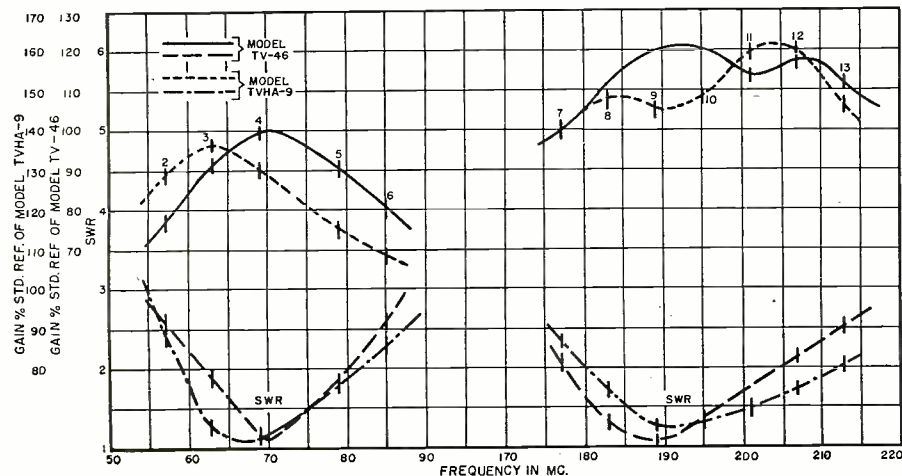

Although antennas under test have been checked against both types of reference, the latter method has been found to be of more practical value in the service field because it requires less expensive equipment and fewer calculations to reproduce. The various curves shown herewith are based on this type of reference.

On a simple dipole antenna, either folded or straight, the uniformity of the response curve depends primarily upon the length of the unit and the ratio of D/L , where D is the diameter of the element and L is the length of the element. For a given unit of this type, the response falls off more rapidly when the frequency is reduced below its nominal resonant frequency than it does when the frequency is increased above the nominal value. Therefore, for usual values of D/L , the unit should be cut somewhat below the center frequency of that portion of the spectrum to be covered. The same statement holds for the design of the low-band unit and the high-band unit, independently, on an antenna of the type shown in Fig. 3A.

Controlling the response curve of an antenna of the type shown in Fig. 3B becomes somewhat more complicated since we have not only the same variables as described above, but also the added variables of spacing between reflector and dipole, as well as the length of the reflector element. With proper manipulation of this greater number of variables, greater control of the response curve is possible, and better "broad-banding" can be obtained. The shape and the actual magnitude of a response curve are both greatly affected by the mechanical configuration of the center insulator, due to the possible "bypass" of signal at this point.

Either of the antenna elements of Fig. 3A would be expected to produce a figure eight horizontal plane pattern, and either bay of the antenna shown in Fig. 3B would be expected to produce a modified figure eight pattern, having a front to rear ratio and forward gain. However, when the two bays of either antenna are combined to feed into one transmission line, extremely "off-shaped" patterns are possible. The interconnecting system between the two antenna bays and the transmission line must properly isolate the two antennas on their respective bands of operation. The low-band antenna, when operating on the high-band frequencies, is approximately $3/2$ wave length for those frequencies, and its pattern will break up into multiple lobes.

If this signal were fed directly into the transmission line along with that coming from the high-band antenna itself, the over-all high-band pattern obviously would be greatly distorted and on some channels would show the multiple lobe formation as established by the large antenna. This makes the elimination of ghosts or reflected images more difficult, impossible in many instances, and dictates, then, the requirement of effectively eliminating the low-band antenna from the system

July, 1949

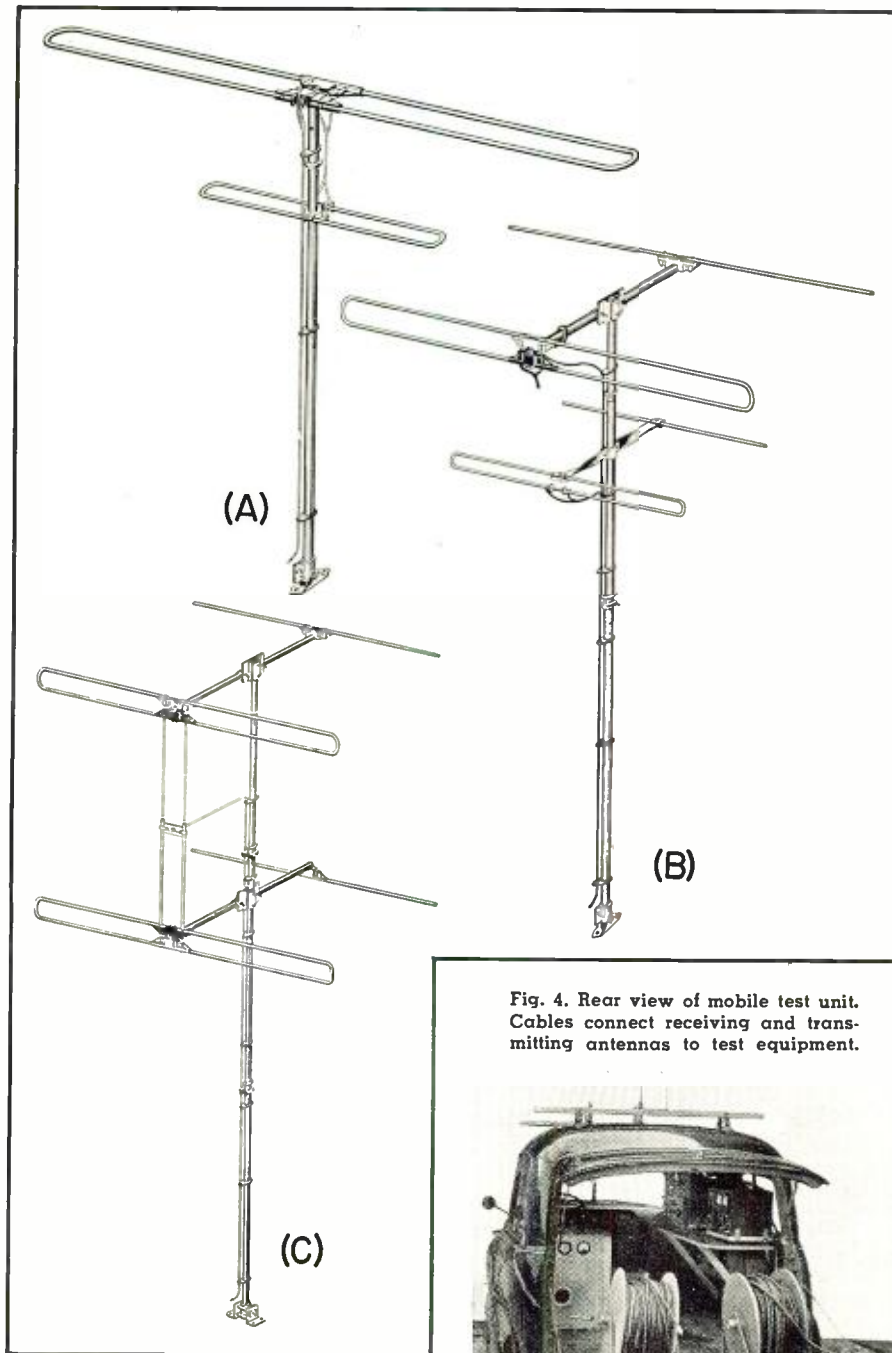

Fig. 3. Three distinct variations of the television antenna: Ward models (A) TV.46 folded high-low band. (B) TVHA9 high-low band folded dipole with reflectors, and (C) high-gain stacked array.

when operation on the high band is desired. This can be accomplished by attaching to the terminals of the low-band antenna an open stub which is quarter-wave length long for the high-band frequencies and will effectively short-circuit the low-band antenna at the high-band frequencies. This short-circuit at high-band frequencies must then be connected to the transmission line with another quarter-wave length stub (or an odd number of quarter-wave lengths) or else it will obviously short-circuit the entire system on the high-band frequencies. However, when it is connected to the transmission line with such a stub, it represents a high

Fig. 4. Rear view of mobile test unit. Cables connect receiving and transmitting antennas to test equipment.



impedance and will have a negligible effect on the system.

The interconnecting system also has a very marked effect on the standing wave ratio since it deals with the combining of two impedances to one transmission line, both impedances varying with frequency in each of the two bands involved. The system described above enables the over-all array to have a remarkably low standing wave ratio on the high band because the impedance of the low-band unit is reflected into the transmission line as a very high impedance, and its disturbing effect on the standing wave ratio is negligible. In fact, it can be made

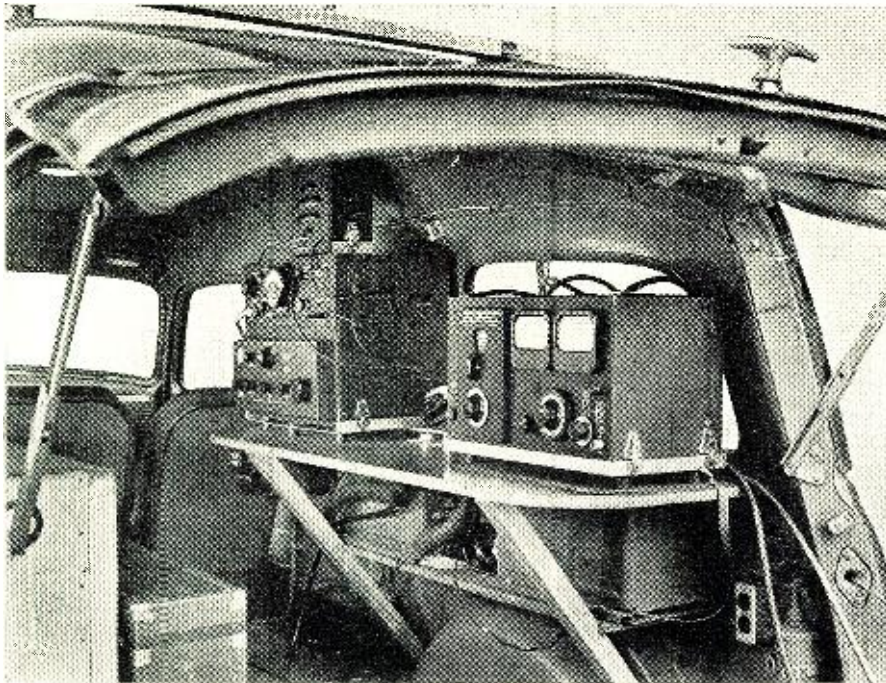

Fig. 5. Interior view of test truck showing part of test equipment.

to have a cancellation effect on the out-of-phase component of the impedance (jX) of a high-band antenna, thus maintaining a low standing wave ratio over a greater portion of the high-band frequencies.

The interaction between the two antennas of such an array is determined primarily by the separation between the two, which is quite simply determined. However, the "loading" of one antenna by the other is likewise affected by this interconnection system. This loading can be either way so that both parts of the interconnection system are of importance. On the low-band frequencies, one of the most important considerations of the small high-band unit is its loading effect on

the large low-band antenna. This can be eliminated by the proper choice of length of link connecting the high-band antenna to the transmission line. Although this problem was attacked originally from the point of view of a simple stub connecting the high-band antenna to the transmission line, results were found in the experimental work which indicated that the length and configuration of the high-band folded dipole had considerable effect on the stub action. Through such experimental work, it was found possible not only to practically eliminate the loading effect of the high-band antenna on the low-band at the low-band frequencies, but to also create a cancellation effect of the out-of-phase

components (jX) of the low-band antenna impedance. This enables the complete system to display a low standing wave ratio over an increased proportion of the low-band frequency.

It can readily be understood from the above that you cannot deal with only a single characteristic of the antenna at a time, since practically all of the characteristics are involved to some extent when any of the variables are altered. The simple change of length of an element will usually call for some comparable change in one or more other parts of the system.

Therefore, to obtain true broad-band response, retain the gain expected from the type of array, have uniformly desirable patterns on all channels, produce low standing wave ratios over wide portions of the spectrum, and have minimum interaction and loading between the antennas, a game of chess results in which the moves cannot be isolated but must be planned in advance due to their effects upon one another.

The problem of the mechanical design of the antenna likewise has several facets. The unit should require minimum assembly time in the field, should handle easily to facilitate erection, and should withstand the battle of the elements.

These factors are again interlocking in their effect upon one another and cannot be considered independently. The requirement of minimum assembly time in the field obviously reduces itself to as complete a preassembly at the factory as possible. However, preassembly by itself does not mean that the antenna will be easy to handle while it is being readied for erection. The antenna should be designed so that the elements and other components will stay in their preassembled position or in their final position and not dangle loosely while the few re-

(Continued on page 92)

Fig. 6. Test pattern of Ward model TVSA-6.

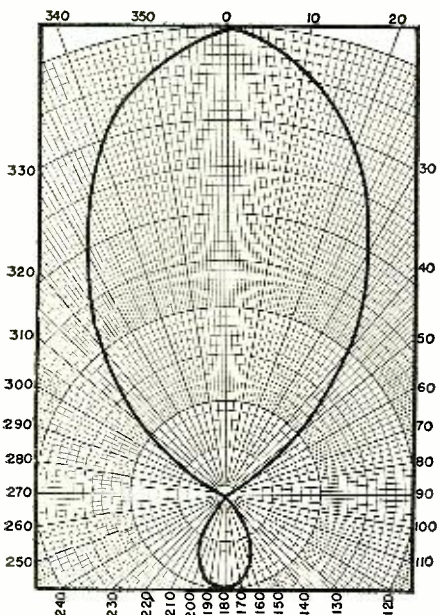
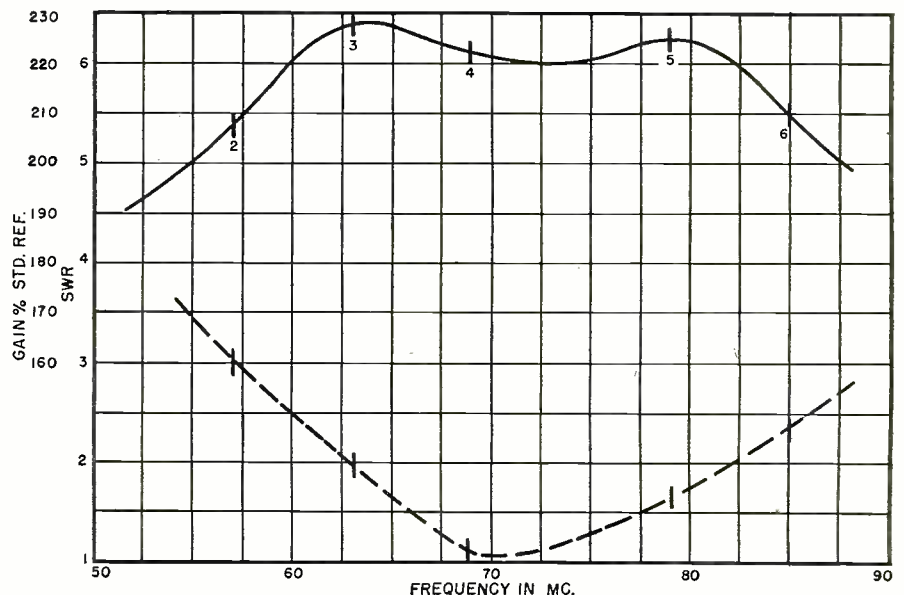
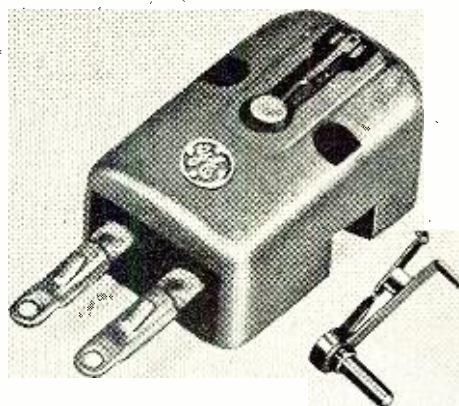

Fig. 7. Frequency response and SWR characteristics of Ward Model TVSA-6 television antenna. Curves clearly indicate that antenna is of good broadband design.



NEW



G-E VARIABLE RELUCTANCE CARTRIDGE

*with the replaceable stylus for
Conventional and Long Playing Records*

NOW—in one small unit—all the sales and performance advantages of the G-E Variable Reluctance Cartridge plus this additional consumer economy feature—the Replaceable Stylus.

Negligible needle scratch and needle talk, minimum record wear, wide frequency response, freedom from resonance peaks, realistic reproduction—these are maintained at all times, simply, easily, economically with the Replaceable Stylus.

No more changing of the entire cartridge means more frequent replacement of stylus by the consumer because he can do it himself so easily.

Four simple steps—and presto! The worn stylus is replaced and maximum high quality performance is restored for the critical listener.

Note, too, these additional features: 

- New notched design . . . one-third smaller . . . improved shape . . . more generally adaptable to various tone arms.
- More clearance for record changers.
- Higher lateral compliance for more faithful tracking.
- More economical for the customer—more sales for the dealer.
- Cartridges available for LP records with 1 mil stylus; for conventional records with 3 mil stylus.

For complete information on the new Variable Reluctance Cartridge write: *General Electric Company, Electronics Park, Syracuse, New York.*



1 Simply remove cartridge from tone arm.



2 Use paper clip or wire to force stylus out of the cartridge.



3 Insert new stylus into cartridge with fingers.



4 Press firmly into position with thumb nail.

You can put your confidence in—

GENERAL  ELECTRIC



TYPE "O"

Type "O" Series—shown at right is the 03-11 Plug, with three 30-amp. contacts, fits certain quality types, notably Western Electric.



TYPE "P"

Type "P" Series—P3-CG-12S Plug shown at right, is standard with most broadcast stations and used with RCA and other equipment. . . 7 interchangeable inserts.

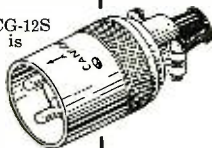

TYPE "XL"

Type "XL" Series—XL-3-11 Plug shown at right, is standard on certain RCA, Electro-Voice and Turner microphones. Two inserts: XL-3, XL-4.

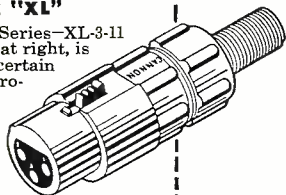

Used on many types of sound and communication equipment in addition to microphone, *Cannon Plugs* are recognized by engineers, sound men and hams as the quality fittings in the field. Over a period of years various improvements have been made in insulating materials, shell design, material and clamp construction.

Available through many parts jobbers in the U. S. A. . . In *Louisville*: Peerless Electronic Equipment Co. In *Flint*: Shand Radio Specialties. In *Syracuse*: Morris Dist. Co. In *Toledo*: Warren Radio. In *Norfolk*: Radio Supply Co.

Bulletin PO-248 covers all the engineering data on the above 3 series; RJC-2 the prices; CED-8 Sheet lists jobbers. For copies address Department G-228.



3209 HUMBOLDT ST., LOS ANGELES 31, CALIF.
IN CANADA—CANNON ELECTRIC CO., LTD.

SUMMARY OF THE NEW PROPOSED AMATEUR RULES AND REGULATIONS OF THE FCC

Elements of the Examination

- | | |
|-----------|---|
| Element 1 | Thirteen w.p.m. |
| 1 (E) | Twenty w.p.m. |
| 1 (NT) | Five w.p.m. |
| 2 | Theory |
| 3 | Laws and Regulations |
| 3 (N) | Beginners Theory: to the point of their understanding of the Rules |
| 4 | Advanced amateur radio telephony |
| 4 (E) | Advanced amateur radio theory, including techniques for operation of narrow bandwidth methods |

Proposed New License Classes

Extra Class—Requirements: Elements: 1 (E), 2, 3, 4, and 4 (E).

Privileges: All amateur privileges including 20 and 75 meter phone.

Renewal: Renewable every five years. Twenty w.p.m. proof may be required even on renewals along with proof of fifty hours operating time during term of license, or ten hours during last six months.

Advanced Class—(Now Class "A"). But *will not exist* after your present license expires. No one will be able to apply for this class after 12-31-50. After your present license (Class "A") expires your renewal will be issued as the new *General Class* (now Class "B"), and you may be called upon to pass before the FCC a thirteen w.p.m.—c.w. exam unless you want to take elements 1 (E) and 4 (E) so that you may apply for the *Extra Class* of License.

Requirements: Elements 1, 2, 3, and 4 as well as a thirteen w.p.m.—c.w. exam.

Privileges: Same as the now Class "A" privileges.

Renewal: Can be renewed only as *General Class* (Class "B").

General Class—(Now Class "B").

Requirements: Elements 1, 2, and 3 as well as thirteen w.p.m.—c.w. exam.

Privileges: Same as the now Class "B" license.

Renewal: Proof of fifty hours operating during last five years as well as thirteen w.p.m.

Conditional Class—(Now Class "C").

Requirements: Same as *General Class* (Class "B") except that applicant lives more than 125 miles from examination point.

Privileges: Same as *General Class* (Class "B") except that applicant lives more than 125 miles from examination point.

Renewal: Same as *General Class* (Class "B") except that applicant lives more than 125 miles from examination point.

Technician Class—(New).

Requirements: Elements 1 (NT), 2 and 3.

Privileges: All frequencies above 220 mc.

Renewal: Proof of fifty hours operating in last five years or ten hours in last six months as well as five w.p.m.

Noice Class—(New). (One year term, not renewable.)

Requirements: Elements 1 (NT), and 3 (N).

Restricted to 75 watts input power.

Privileges: 3700-3750 kc., Type A-1 emission only, crystal controlled. 14,100-14,150 kc., Type A-1 emission only, crystal controlled. 28.0-28.5 mc., Type A-1 only, crystal controlled. 145-147 mc., Type A-1 or Type A-3 emission (no pulse emission allowed).

Changes of existing rules as to sub-band allocations. 3500-4000 kc. Type A-1 only. 3800-3850 kc. all types of radio telephone (except pulse). Restricted to 3 kc. bandwidth. This portion limited to *extra class of license or advanced class* (Class "A"). 3850-4000 kc. any type of radio telephone (except pulse). This portion restricted to 6 kc. bandwidth. Further restricted to holders of *extra class or advanced class* (Class "A"). 14,000-14,400 kc. Type A-1 emission. 14,200-14,300 kc. radio telephone (except pulse) restricted to 6 kc. bandwidth. Further restricted to holders of *extra class or advanced class* (Class "A"). 28.0-29.7 mc. Type A-1 emission only. 29.0-29.7 carrier shift—not more than 1 kc. 28.5-29.65 radio telephone (except pulse). Bandwidth 10 kc. 29.65-29.7 radio telephone (except pulse). Bandwidth 6 kc.

Any interested party who is of the opinion that the proposed amendments should not be adopted, or should not be adopted in the form set forth may file with the Commission, on or before July 20, 1949, a written statement or brief setting forth his comments. At the same time, persons favoring the amendments as proposed may file statements in support thereof. The Commission will consider any such comments that are received before taking any final action regarding the proposed amendments, and if any comments are received which appear to warrant the holding of a hearing or oral argument before final action is taken, notice of the time and place of such hearing or oral argument will be given.

In accordance with Section 1.764 of the Commission's Rules and Regulations, an original and at least fourteen copies of all statements, briefs or comments shall be furnished the Commission.



ELECTRONIC BARGAINS for EXPERIMENTERS and HOBBYISTS

ORDER NOW . . . ALL QUANTITIES LIMITED

PE101C BC645 POWER SUPPLY
NO. 273. Complete power supply for BC 645. Operates from 12 or 24 Volts. Supplies both AC and DC required. Shipping Wgt. 13 lbs. Each **\$3.95**

DM 35 12 VOLT DYNAMOTOR
NO. 274. New input 12 Volt at 18.7 Amperes. Supplies 675V at 275 MA or 1/2 above voltage from 6 volts. Excellent for auto use. Shipping Wgt. 11 lbs. Each **\$7.50**

HOME WORKSHOP GRINDER KIT

NO. 230. Easily assembled 110V AC or DC ball bearing fully enclosed motor from Army surplus dynamotor. Purchaser to make simple changes and shaft extensions, detailed instructions and all parts supplied. Motor approximately 5,000 R.P.M. Ideal for tool-post grinder, flexible shaft tool, model drill press, saw. Shipping Weight 6 lbs. **\$3.95**

COLLINS AUTOTUNE CONTROL HEAD

NO. 278. Brand new controls used on the ART/13, 100 Watt, Transmitter. Types 7, 8, 10, and 11 available. Get a spare while available as new cost is over \$22.00 each. Shipping Wgt. 3 lbs. Price any type (mention when ordering). Each **\$4.50**

300 MA SELENIUM RECTIFIERS
NO. 209. Rated 300 MA at 36 Volts, complete with mounting brackets. Shipping Wgt. 1 lb. **3 FOR \$1.00**

1N90 FEED THROUGH INSULATOR

NO. 276. Heavy duty feed through, 2" diameter 4" long, complete with brass hardware and gasket. Shipping Wgt. 2 lbs. **2 FOR \$1.00**

1N86 STRAIN INSULATOR

NO. 277. Husky, army type 1 1/4" diameter, 5 1/4" long. Brown porcelain. Shipping Wgt. 4 lbs. **4 FOR \$1.00**

G. E. BC 306 ANTENNA TUNING UNIT

NO. 231. Matches any aerial to 150 Watt transmitter, used on BC 375. Brand new. Add postage for 20 lbs. **\$2.95**

G. E. 1,000 VOLT 350 MA DYNAMOTOR

NO. 213. An ideal dynamotor for mobile operation in taxicabs, police cars, sound systems and amateur stations. Supplies above voltage from 12 Volts or 500V. at 350 MA from 6 Volts. Complete with starting relay, and fuses. New. Our Dynamotor A. Shipping Weight 72 lbs. **\$5.95**

POWER TRANSFORMER Specials

NO. 226. Primary 117V. 60 cycle. Secondaries supply 746 V.C.T. at 220 MA, 6.3V. at 4.5 A., and 5V. at 4A. Will handle 13 tube radio receivers. Supply is limited, order early. Shipping Weight 11 lbs. each. **\$3.95 . . . 3 for \$9.95**

T32 TABLE MICROPHONE

NO. 210. One of the Army's best. Built by Kellogg, ideal for factory call system, public address, amateur use. Brand new in original cartons. Add postage for 5 lbs. **\$2.95**

MINIATURE ELECTRIC MOTOR

NO. 211. Tiny Delco motor only 1" x 1 1/4" x 2" 10,000 RPM. Operates from 6 to 24 V. Excellent for models. Add postage for 1 lb. **\$2.95**

OUTPUT TRANSFORMER

NO. 227. Push pull 6V6's to 6-8 ohm voice coil excellent characteristics. **3 for \$1.95**

RCA SATURABLE REACTOR TRANSFORMER

NO. 246. New RCA No. CKV30531 AC current 750 MA DC current 2 Amperes. Rated 1.75 henries. Shipping wgt. 4 lbs. Each **\$1.00**

12.6V POWER TRANSFORMER

NO. 247. New cased 110 V 60 cy. Power Transformer. Supplies 440V Ct. at 60 MA, 6.3V at 2A. and 12.6V at 1 Amp. Excellent for military sets. Shipping Wgt. 6 lbs. Each. **\$1.95**

RCA INPUT TRANSFORMER

NO. 248. Heavy duty RCA No CKV-30529. Input has primaries 600 to 200 and 25 ohms secondary 250,000 ohms C.T. Shipping Wgt. 2 lbs. Each **\$1.00**

FEDERAL POWER TRANSFORMER

NO. 252. New cased 110V 60 cy. Power Transformer. Supplies 480V CT at 50 MA and 6.3 V at 2.1 Amps. A beautiful transformer. Shipping Wgt. 4 lbs. Each **\$1.50**

MILITARY POWER TRANSFORMERS

NO. 229. Convert your military receivers without rewiring the filament. "A" type supplies 500 VCT at 50 MA, 5V. at 2A. and 24V. at 1/2 A. "B" type supplies 500 VCT at 50 MA, 5V. at 2A. and 12V. at 1 Amp. State whether A or B type desired. **\$2.95** Shipping Weight 4 lbs.

WALKIE TALKIE TRANSFORMER

No. 744. Carbon microphone input transformer and output to head-phone transformer, all in one case, excellent for building your own. Shipping Wt. 1 lb. **4 for \$1.00**

LOW PASS FILTER UNIT

No. 637. 3000 cycle cutoff consists of 3 inductances and 4 capacitors in network, 500 ohms in and out. Excellent for clipping all frequencies above 3000 cycles. Drawn steel case, shipping Wt. 5 lbs. **\$2.50**

FM PUSH BUTTON TUNER

NO. 224. Brand new ten push button tuning assembly from Army FM receiver. Contains 4 gang 100 MMF silver plated tuning condenser. Add postage for 10 lbs. **\$2.50 EACH**

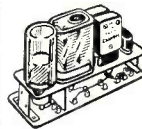

BC 746 TUNING UNIT
NO. 257. Plug in transmitter tuning unit from army Walkie Talkie. Contains antenna and tank coils, tuning condenser, transmitting and receiving crystals. Ideal transmitter foundation. Shipping Wgt. **\$1.00**
1 lb. Each
(Same as above except transmitter crystal in 80 meter amateur band \$2.50 each)

T30 THROAT MICROPHONE

NO. 258. Makes excellent contact microphone for musical instrument or vibration pick-up. Shipping Wgt. 1 lb. **\$1.00 each**
Extension cord with switch for above \$.50 each

BC 731 CONTROL BOX

with Weston Model 476 AC Voltmeter
NO. 208. Excellent buy in motor control box. Size 8"x10"x5 1/2". Contains Weston 0-150V. AC 3 1/2" voltmeter, motor starting switch, 28 fuses all 30 Amp 110V. and 8 fuse holders. Fuses and holders alone worth the price. **\$7.95**
Shipping Weight 18 lbs.

METER SPECIAL

NO. 237. Brand new DeJur Model 312 0-800 M.A. D.C. Square 3" 0-10 M.A. basic meter with built in shunt. Probably the best buy ever offered in a surplus meter. **\$2.95**
Shipping Weight 1 lb.

HEARING AID HEADPHONES

NO. 216. The Army's best - eliminate flat ears and outside noise. Complete with transformer for conversion from low to high impedance. With cord and plug complete. **\$1.00**
Add postage for 1 lb.

BC 451 CONTROL BOX

NO. 236. Control box for 274N transmitters. Contains proper c-w-voice switch, 4 channel switch, power switch, mike jack and telegraph key. **\$1.95**
Add postage for 2 lbs.

100 MA FILTER CHOKE

No. 641. Heavy 1.5 henry choke in drawn steel case, 50 ohm resistance, conservatively rated at 100 MA. Shipping Wt. 1 lb. **50c**

FILAMENT TRANSFORMER

No. 922. 220V. 60 cy. primary supplies 12.6V. at 3.5 Amps, 15.6V at 1 Amp. Supplies 6.3 at 3.5 Amps and 7.8V. at 1. Amp from 110V. Shipping Wt. 8 lbs. **\$1.50**

PANEL METER

Burlington O-300 VAC Meter
No. 290. Model 32XA 3 1/2" round AC Voltmeter 0-300 VAC full scale. Scale also calibrated 0-600V. Bakelite case. A beautiful meter in original carton. Shipping Wt. **\$3.95**

DRIVER TRANSFORMER

No. 651. Couples 3000 ohm plate to push pull parallel grids hermetically sealed. Ship. Wt. 1 lb. **\$1.00**

OUTPUT and MODULATION TRANSFORMER

No. 745. Companion transformer to above driver. A push pull output, 3000 ohms to 3.2 ohm voice coil, or to 1250 ohms at 80 MA. A high quality cased unit. Shipping Wt. 2 pounds. **\$1.00**

HOW TO ORDER . . . GIVE PART NUMBER AND DESCRIPTION . . . ADD POSTAGE FOR WEIGHT SHOWN. NO ORDERS UNDER \$2.00 . . . WE WILL SHIP C.O.D.



The HEATH COMPANY

. . . BENTON HARBOR 15, MICHIGAN

It's a Natural

BUILD YOUR OWN

Heathkit SINE AND SQUARE WAVE AUDIO GENERATOR KIT



\$34⁵⁰
Nothing
ELSE TO BUY

Experimenters and servicemen working with a square wave for the first time invariably wonder why it was not introduced before. The characteristics of an amplifier can be determined in seconds compared to several hours of tedious plotting using older methods. Stage by stage, amplifier testing is as easy as signal tracing. The low distortion (less than 1%) and linear output (\pm one db.) make this Heathkit equal or superior to factory built equipment selling for three or four times its price. The circuit is the popular RC tuning circuit using a four gang variable condenser. Three ranges 20-200, 200-2,000, 2,000-20,000 cycles are provided by selector switch. Either sine or square waves instantly available at slide switch. All components are of highest quality, cased 110V. 60 cycle power transformer. Mallory F.P. filter condensers, 5 tubes, calibrated 2 color panel, grey crackle aluminum cabinet. The detailed instructions make assembly an interesting and instructive few hours. Shipping Wt., 13 lbs.

New Heathkit TELEVISION ALIGNMENT GENERATOR KIT



\$39⁵⁰

Nothing
ELSE TO BUY

Everything you want in a television alignment generator. A wide band sweep generator covering all FM and TV frequencies 0-110 and 165 to 220 Megacycles, a marker indicator covering 19 to 43 Megacycles, AM modulation for RF alignment — variable calibrated sweep width 0-30 Mc. — mechanical driven inductive sweep. Husky 110V. 60 cycle power transformer operated — step type output attenuator with 10,000 to 1 range — high output on all ranges — band switching for each range — vernier driven main calibrated dial with over 45 inches of calibration — vernier driven calibrated indicator marker tuning. Large grey crackle cabinet 16 $\frac{1}{8}$ " x 10 $\frac{3}{8}$ " x 7-3/16". Phase control for single trace adjustment. Uses four high frequency triodes plus 5Y3 rectifier — split stator tuning condensers for greater efficiency and accuracy at high frequencies — this Heathkit is complete and adequate for every alignment need and is supplied with every part — cabinet — calibrated panel — all coils and condensers wound, calibrated and adjusted. Tubes, transformer, test leads — every part with instruction manual for assembly and use. Actually three instruments in one — TV sweep generator — TV AM generator and TV marker indicator. Also covers FM band.

1949 MODEL Heathkit VACUUM TUBE VOLTMETER KIT

Features

New 200 μ a Meter
24 Ranges

New Accessory H.V. Probe makes
Heathkit a kilovoltmeter. (Extra)

New Accessory R.F. Probe extends range
to 100 megacycles. (Extra)

A new Model V2 Heathkit VTVM with new 200 microampere meter, four additional ranges — full scale linear ranges on both AC and DC of 0-3V., 10V., 30V., 100V., 300V. and 1,000V. Accessory probe listed elsewhere in ad extends voltage range to 3,000 and 10,000 volts D.C. New model has greater sensitivity, stability and accuracy — still the highest quality features — shatterproof plastic full view meter face — automatic meter protection, push pull electronic voltmeter circuit, linear scales — db. scale — ohmmeter measures 1/10 ohm to 1 billion ohms with internal battery — isolated DC test prod for dynamic measurements — 11 megohm input resistance on DC — AC uses electronic rectification with 6H6 tube. All these features and still the amazing price of only \$24.50. Comes complete with cabinet — panel — three tubes — new Mallory switches — test prods and leads, 1% ceramic divider resistors and all other parts. Complete instruction manual for assembly and use. Better start your laboratory with this precision instrument. Shipping Wt., 8 lbs.

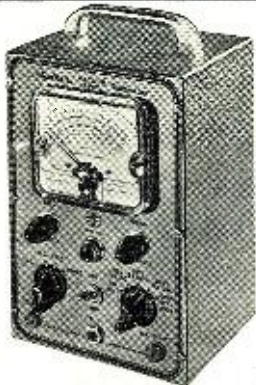

\$24⁵⁰

Heathkit RF SIGNAL GENERATOR KIT

\$19⁵⁰

Nothing ELSE TO BUY

Every shop needs a good signal generator. The Heathkit fulfills every servicing need, fundamentals from 150 Kc. to 30 megacycles with strong harmonics over 100 megacycles covering the new television and FM bands. 110V. 60 cycle transformer operated power supply. 400 cycle audio available for modulation or audio testing. Uses 6SN7 as RF oscillator and audio amplifier. Complete kit has every part necessary and detailed blueprints and instructions enable the builder to assemble it in a few hours. Large easy to read calibration. Convenient size 9" x 6" x 4 $\frac{3}{4}$ ". Shipping Wt., 4 $\frac{1}{2}$ lbs.

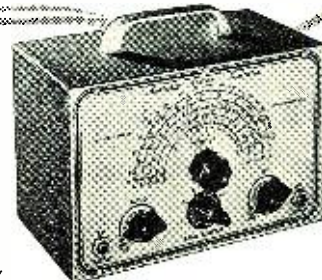

New Heathkit FM TUNER KIT



\$14⁷⁵
CABINET EXTRA

A truly fine FM Tuner with the coils ready wound, all alignment completed — all that is necessary is wiring and it's ready to play — uses super regenerative circuit — 110V. 60 cycle transformer operated — two gang tuning condenser — slide rule calibrated dial — two tubes — complete instructions including pictorial enable even beginners to build successfully. Shipping Wt., 4 lbs. Beautiful mahogany cabinet for FM Tuner (shown above) extra \$3.75



The HEATH COMPANY

... BENTON HARBOR 15, MICHIGAN

with **HEATHKITS...**

HAVE THE FUN
Save THE DIFFERENCE
WITH HEATHKITS

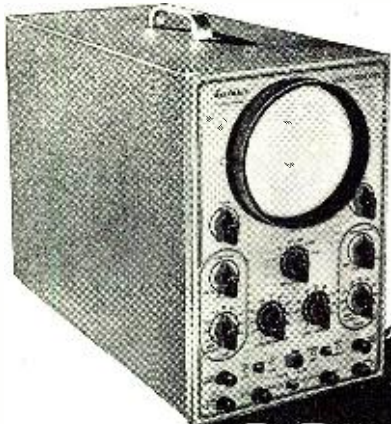

Heathkit 5" OSCILLOSCOPE KIT

Features

Instant switching to plates or amplifier from front panel.
Sweep generator supplying variable sweep 15 cycles to 30,000 cycles.
All controls on front panel.
Cased electrostatically shielded 110V. 60 cycle power transformer.
AC test voltage on front panel.
External synchronization post on front panel.
Deflection sensitivity .65V. per inch full gain.
Frequency response $\pm 20\%$ from 50 cycles to 50 Kc.
Input impedance 1 Megohm and 50 MMF.

The Heathkit 5" Oscilloscope fulfills every servicing need. The husky cased power transformer supplies 1100 Volts negative and 350 Volts positive. Tubes supplied are two 6SJ7 amplifiers, 884

sweep generator, two 5Y3 rectifiers and 5BP1 CR tube. Grey crackle aluminum cabinet and beautiful grey and maroon panel. Chassis especially designed for easy assembly.

An oscilloscope provides endless sources of experimentation in radio, electronics, medicine and scientific research.

Detailed instructions make assembly fun and instructive. Shipping Wt., 24 lbs. Express only.

Nothing
ELSE
TO BUY

\$39.50

NEW Heathkit SIGNAL TRACER AND UNIVERSAL TEST SPEAKER KIT



\$19.50

Nothing
ELSE
TO BUY

The popular Heathkit signal tracer has now been combined with a universal test speaker at no increase in price. The same high quality tracer follows signal from antenna to speaker—locates intermittents—defective parts quicker—saves valuable service time—gives greater income per service hour. Works equally well on broadcast—FM or TV receivers. The test speaker has assortment of switching ranges to match push pull or single output impedance. Also test microphones, pickups—PA systems—comes complete—cabinet—110V. 60 cycle power transformer—tubes, test probe, all parts and detailed instructions for assembly and use. Shipping Wt., 8 lbs.

Heathkit

ELECTRONIC SWITCH KIT

DOUBLES THE UTILITY OF ANY SCOPE

\$34.50

Nothing
ELSE TO BUY



An electronic switch used with any oscilloscope provides two separately controllable traces on the screen. Each trace is controlled independently and the position of the traces may be varied. The input and output traces of an amplifier may be observed one beside the other or one directly over the other illustrating perfectly any change occurring in the amplifier. Distortion—phase shift and other defects show up instantly, 110V. 60 cycle transformer operated. Uses 5 tubes (1 6X5, 2 6SN7's, 2 6SJ7's). Has individual gain controls, positioning control and coarse and fine sweeping rate controls. The cabinet and panel match all other Heathkits. Every part supplied including detailed instructions for assembly and use. Shipping Wt., 11 lbs.

Heathkit CONDENSER CHECKER KIT

\$19.50

Nothing
ELSE
TO BUY



Features

- Bridge type circuit
- Magic eye indicator
- 110 V. transformer operated
- All scales on panel
- Power factor scale
- Measures resistance
- Measures leakage
- Checks paper-mica-electrolytics

Checks all types of condensers, paper-mica-electrolytic-ceramic over a range of .00001 MFD to 1000 MFD. All on readable scales that are read direct from the panel. NO CHARTS OR MULTIPLIERS NECESSARY. A condenser checker anyone can read without a college education. A leakage test and polarizing voltage for 20 to 500 volts provided. Measures power factor of electrolytics between 0% and 50%. 110V. 60 cycle transformer operated complete with rectifier and magic eye tubes, cabinet, calibrated panel, test leads and all other parts. Clear detailed instructions for assembly and use. Why guess at the quality and capacity of a condenser when you can know for less than a twenty dollar bill. Shipping Wt., 7 lbs.



The HEATH COMPANY

... BENTON HARBOR 15, MICHIGAN

Heathkits
ARE COMPLETE

HEATHKITS are QUALITY



Only
\$69.50

Nothing ELSE TO BUY

New Heathkit
IMPEDANCE BRIDGE KIT

A LABORATORY INSTRUMENT NOW WITHIN
THE PRICE RANGE OF ALL

Measures Inductance from 10 microhenries to 100 henries capacitance from .00001 MFD to 1000 MFD. Resistance from .01 ohms to 10 megohms. Dissipation factor from .001 to 1. "Q" from 1 to 1000.

Ideal for schools, laboratories, service shops, serious experimentors.

An impedance bridge for everyone — the most useful instrument of all, which heretofore has been out of the price range of serious experimentors and service shops. Now at the lowest price possible. All highest quality parts. General Radio main calibrated control. General Radio 1000 cycle hummer. Mallory ceramic switches with 60 degree indexing — 200 micro-amp zero center galvanometer — 1/2 of 1% ceramic non-inductive decade resistors. Professional type binding posts with standard

3/4" centers. Beautiful birch cabinet. Directly calibrated "Q" and dissipation factor scales. Ready calibrated capacity and inductance standards of Silver Mica, accurate to 1/2 of 1% and with dissipation factors of less than 30 parts in one million. Provisions on panel for external generator and detector. Measure all your unknowns the way laboratories do — with a bridge for accuracy and speed.

Internal 6 volt battery for resistance and hummer operation. Circuit utilizes Wheatstone, Hay and Maxwell circuits for different measurements. Supplied complete with every quality part — all calibrations completed and instruction manual for assembly and use. Deliveries are limited. Shipping weight, approximately 15 lbs.

Heathkit HIGH FIDELITY
AMPLIFIER KIT

Build this high fidelity amplifier and save two-thirds of the cost. 110V. 60 cy. transformer operated. Push pull output using 1619 tubes (military type 6L6's), two amplifier stages using a dual triode (6SL7), as a phase inverter give this amplifier a linear reproduction equal to amplifiers selling for ten times this price. Every part supplied; punched and formed chassis, transformers (including quality output to 3-8 ohm voice coil), tubes, controls, and complete instructions. Add postage for 20 lbs.

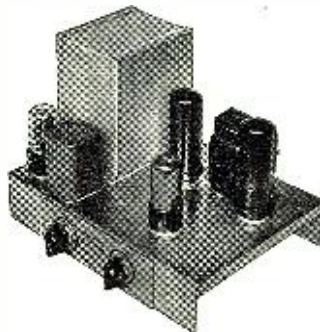

\$14.95

Nothing ELSE TO BUY

12" PM Speakers for above..... \$6.95

Mahogany Speaker Cabinet, 14 1/2" x 14 1/2" x 8"..... \$8.75

New Heathkit
BATTERY ELIMINATOR KIT

Now a bench 6 Volt power supply kit for all auto radio testing. Supplies 5 - 7 1/2 Volts at 10 Amperes continuous or 15 Amperes intermittent. A well filtered rugged power supply uses heavy duty selenium rectifier, choke input filter with 4,000 MFD of electrolytic filter. 0 - 15 Volt meter indicates output. Output variable in eight steps. Excellent for demonstrating auto radios. Ideal for servicing — can be lowered to find sticky vibrators or stepped up to equivalent of generator overload — easily constructed in less than two hours. Complete in every respect. Shipping Wt., 18 lbs.



\$22.50

Nothing
ELSE TO BUY

Heathkit
3-TUBE ALL WAVE RADIO KIT



\$8.75

CABINET EXTRA

An ideal way to learn radio. This kit is complete ready to assemble, with tubes and all other parts. Operates from 110V AC. Simple, clear detailed instructions make this a good radio training course. Covers regular broadcasts and short wave bands. Plug-in coils. Regenerative circuit. Operates loud speaker. Shipping Wt., 3 lbs.

H530 Headphones per set..... \$1.00
2 1/2" Permanent Magnet Loudspeaker..... 1.95
Mahogany Cabinet..... 2.95



The **HEATH COMPANY**

BENTON HARBOR 15, MICHIGAN

What's New in Radio

DUAL CONTROL FILTER

The Minnesota Electronics Corporation, 97 East Fifth Street, St. Paul 1, Minnesota, has designed a dual control noise suppression filter, Model NSF-1, to obtain maximum music with minimum noise. It is installed between any electronic input device, such as a preamplifier or radio tuner

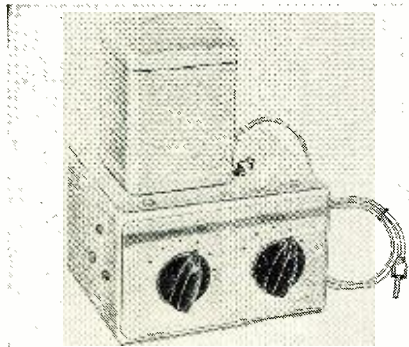

and the input to the audio amplifier.

This dual control unit is designed without dynamic action and consists of a broad, five-position range switch control and the suppression control, which is a vernier tuning control for continuous adjustment between the fixed positions of the range switch. The dimensions are 6½ by 5 by 4 inches.

The listener can choose straight-through operation or any high-frequency cutoff between 3500 and 16,000 cycles-per-second, with attenuation beyond the selected frequency at the rate of 20 db. or more per octave. It is equally effective on all types of signals, standard and LP phonograph records, AM and FM radio, and television sound and magnetic recordings.

REINER HVM SUPERPROBE

The new superprobes manufactured by Reiner Electronics Co., Inc., 152 West 25th St., New York 1, N. Y., are designed for accurate measurement of high voltages in television sets, x-ray machines, and other apparatus with

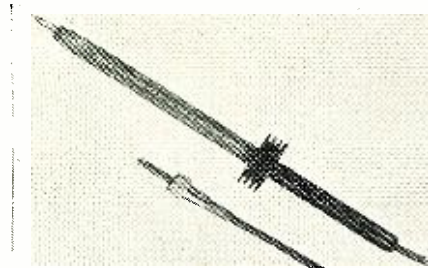

greater ease and safety, when combined with any vacuum tube voltmeter the operator possesses.

That portion of the probe gripped by the hand remains relatively cold, and the long slenderized hot portion

of the probe is separated from the handle by heavy-duty labyrinth barriers, making it easy to get into tight places.

The multipliers extend the range of vacuum tube voltmeters 100 times, so that the true reading with multiplier is simply 100 times the reading of the instrument when used with the HVM superprobe. For example, a reading of 270 volts with the multiplier would indicate an actual voltage of 27,000. The probes are rated for use up to 30,000 volts, and have an extensive safety factor.

NEW SERIES "300"

The manufacturer of the Ampex magnetic tape recorders, Audio & Video Products Corp., 1650 Broadway, New York, N. Y., announces the presentation of the New Series "300" in portable, rack mount, and console models.

This model is said by the manufacturer to be well within the price range of universities, churches, music pub-



lishers, language and diction studios, and other fields where high-quality reproduction is required.

The console has the same dimensions as standard transcription-playback turntables. The operating speed is 15" per-second for one-half hour playing time, and 7.5" per-second for an hour's playing time. Frequency response is plus or minus 2 db., 50 to 15,000 cycles at 15" per-second and plus or minus 2 db. from 50 to 7500 cycles at 7.5" per second.

"TAPETONE" SOUND RECORDER

Previously available only in kit form, the "Tapetone" Magnetic Tape Sound Recorders may now be obtained factory assembled, complete and ready to operate, from the Tapetone Manufacturing Corporation, 202 Tillary St., Brooklyn 1, N. Y. The kits still remain available to those who wish to build their own.

The medium for sound reproduction is Scotch recording tape, three times

as strong as wire. As only one edge of the tape is employed, editing is easy, and another interesting feature

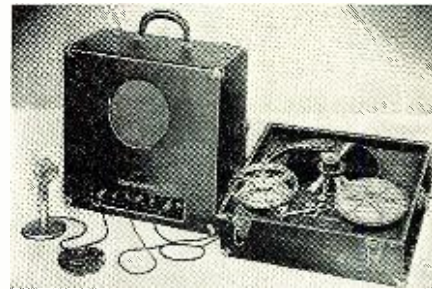

of "Tapetone" is that as the recording is made, any previous signal is automatically erased, and the new signals impressed will keep indefinitely.

The mechanism, precision built, is simple in design with only four moving parts, making for more quiet and trouble-free operation.

TV TUBE ION TRAP

Two new types of TV tube beam benders are offered by Clarostat Mfg. Co., Inc., Dover, N. H., the TV-2, intended for the 10-inch kinescope tube, and the TV-3, more elaborate, which is intended primarily for 12-inch and larger tubes.

These devices slip over the necks of the tubes and are regular equipment in many television receivers, serving to minimize burnt spots on tube screens. Both types of Clarostat beam-benders have rubber-covered spring arms for friction fit on a 1¾ inch to 1½ inch TV tube neck. All parts except rubber sleeves and ring magnet are cadmium-plated.

Series TV-2 features a single permanent bar magnet, while the higher-cost TV-3 features two, the bar magnet for the rear and the ring magnet for the front elements.

TELE-TURN TABLE

Production of a new turntable has been announced by the Krenco Manu-

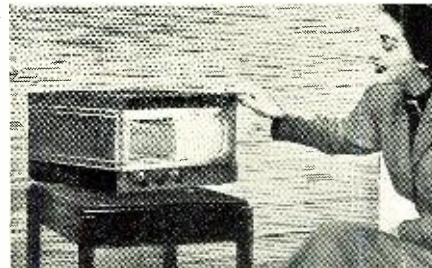

facturing Company, 231 S. La Salle St., Chicago 4, Ill. This product is to be used for all table top and console type television sets, allowing the

CHICAGO

The Name that Makes NEWS in TRANSFORMERS

TELEVISION TRANSFORMERS

to fit today's leading
TV circuits

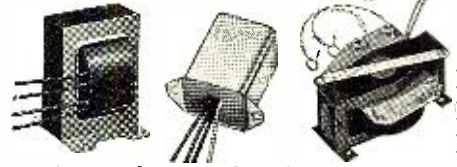

A complete catalog line, made by CHICAGO—the largest single manufacturer of original equipment TV transformers. Included are power, vertical blocking oscillator, and both vertical and horizontal scanning output transformers in a range of designs that are exact duplicates of units used in the leading TV sets.

POWER TRANSFORMERS

A Complete Line
in 2 alternate
"Sealed in Steel"
Mountings



Exclusive features like these make this the "Engineer's Line": Plate and filament voltages to fit today's most-used tubes; in two mountings—with solder lugs or 10" leads; one series for condenser input, another for reactor input use; exactly matching reactor for each power transformer. Get complete catalog now.

HIGH Q CHOKES

for Dynamic
Noise Suppression
Circuits



Two efficient filter reactors, inductance values .8 and 2.4 henrys respectively, are designed for noise suppression circuits, but can be used in any tuned circuit requiring the given inductances. Inductance values are accurate within $\pm 5\%$ with up to 15 ma. d-c. Minimum Q of 20. Mounted in identical drawn steel cases $1\frac{1}{16}'' \times 2\frac{3}{8}'' \times 1\frac{1}{16}''$. Write for descriptive sheet including diagram of simplified dynamic circuit.

FULL FREQUENCY RANGE AUDIO TRANSFORMERS

within $\pm \frac{1}{2}$ db.
typical response
30 to 15,000 cycles



For uniformly low distortion, for response curves that are truly flat over the full frequency range, use these CHICAGO input and output units. Get the facts on the BO-6 (P-P 6L6's to 6/8 or 16/20-ohm speaker), the BO-7 (600/150-ohm line to 6/8 or 16/20-ohm speaker), and other CHICAGO full frequency units—they're tops in transformers.

ISOLATION TRANSFORMERS

for safer,
more efficient
servicing



For isolating chassis ground from line ground and eliminating the shock hazard (important on "hot" TV sets). Dual purpose: where line is under/over voltage, sec. supplies 115 v.; with 115-volt line, sec. supplies 125/115/105 volts (high/low volts help find doubtful tube, etc.). Three sizes: 50, 150, or 250-VA. to cover full range of servicing needs.

MODULATION TRANSFORMER

for
Ham and
Commercial
Transmitters



A Modulation Transformer ideally suited for use in ham and commercial speech transmitters. Will deliver 250 watts of Class B audio power from P-P 203A's, 211's, 805's, 75TL's, etc. to a Class C load with response variations not exceeding ± 1 db. over the speech range, 200-3,500 cycles. Primary impedances, 9000/6700 ohms; secondary impedances, 8000/6000/4000 ohms. A matching driver transformer is available.

REPLACEMENT TRANSFORMERS

Premium
Quality
Yet They
Cost No More

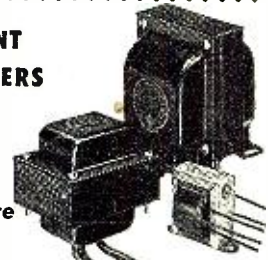

The new CHICAGO Replacement Line provides servicemen with a wide range of standard ratings that fit the most frequent power and audio transformer requirements. These units, backed by CHICAGO's 20 years of manufacturing experience represent the finest quality attainable through engineering ingenuity and precision manufacture—yet they cost no more.

TOROID COILS available in 3 sizes, wound to your specifications, or incorporated in filter designs. New CHICAGO equipment and techniques achieve precision accuracy. Inquiries for any production quantity are invited.

Write for complete CHICAGO Transformer Catalogs

CHICAGO TRANSFORMER

DIVISION OF ESSEX WIRE CORPORATION

3501 ADDISON STREET • CHICAGO 18, ILLINOIS



TRADE MARK REG.

For Clearer Television!

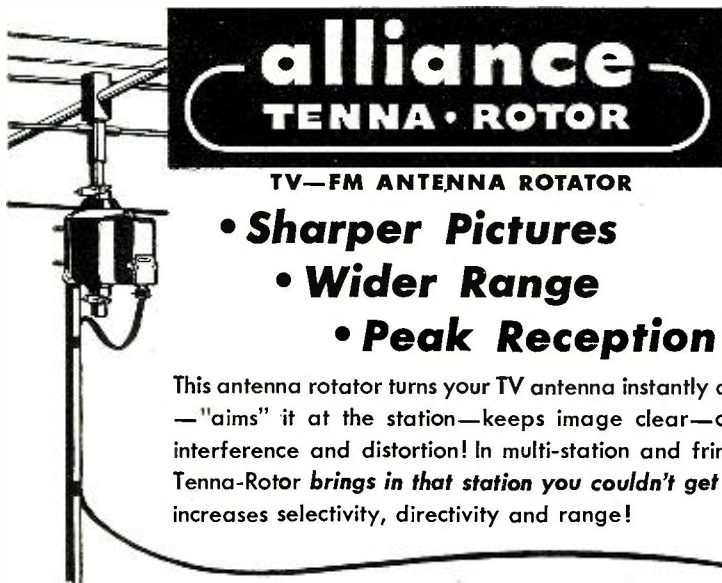

alliance
TENNA · ROTOR

TV—FM ANTENNA ROTATOR

- Sharper Pictures
- Wider Range
- Peak Reception!

This antenna rotator turns your TV antenna instantly as needed — "aims" it at the station—keeps image clear—overcomes interference and distortion! In multi-station and fringe areas Tenna-Rotor *brings in that station you couldn't get before*—increases selectivity, directivity and range!

Weather-proof enclosed electric rotor unit, (size 7" x 8") fits antenna mast—is quick and easy to install—self-lubricated for long life! Smart, plastic remote-control case plugs into 110-volt house circuit. Price \$39.95. (Slightly higher west of Rockies.) Complete assembly, rotor and control case, weighs 12 lbs. End your "fixed position" antenna worries — ask your dealer or service shop!

Ask for Alliance 4-Conductor Cable made especially for Tenna-Rotor!

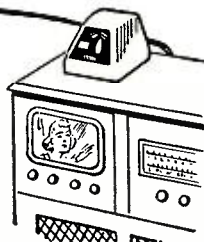

ALLIANCE MANUFACTURING COMPANY • ALLIANCE, OHIO

Export Department; 401 Broadway, New York, N. Y., U. S. A.

SHOOTS TROUBLE FASTER!

MAKES MORE MONEY FOR YOU ON JOB OR AT SERVICE BENCH!



PRICE \$9.95

at distributor or postpaid, direct. Sorry, no C.O.D.'s. Ohioans add 3% State Sales Tax

Signalette

MULTI-FREQUENCY GENERATOR

In radio service work, time means money. Locate trouble faster, handle a much greater volume of work with the SIGNALETTE. As a trouble shooting tool SIGNALETTE has no equal. Merely plug in any 110 V. AC-DC line, start at speaker end of circuit and trace back, stage by stage, listening in set's speaker. Generates RF, IF and AUDIO Frequencies. 2500 cycles to 20 Megacycles. Also used for Checks on Sensitivity, Gain, Peaking, Shielding, Tube testing. Wt. 13 oz. Fits pocket or tool kit. See at your distributor or order direct.

Clippard Instrument Laboratory, Inc.

DEPT. N, 1125 BANK STREET
CINCINNATI 14, OHIO

QUALIFIED JOBBERS WRITE, WIRE FOR DETAILS.

HIWAY COMPANY

Hot July Bargains!

TUBE OF THE MONTH—813

Brand new, boxed Ea. **\$6.75**
Order 4 for \$24.50 and we prepay shipping!

INTERPHONE AMPLIFIER

CMX-50128. For general radio use. Used with TCS equipment, PP 12A6s, complete with 12V. dynamotor and instruction book. Condition is new, not factory packaged. Wt. 19 lbs. Ea. **\$9.25**

2-IN-1 SPECIAL!!!

BC-458, 4-5.3 Mcs. Transmitter PLUS BC-457, 5.3-7 Mcs. Transmitter, ALSO rack, mounting, plugs. Good condition guaranteed. Wt. 25 lbs. The whole deal **\$10.00**

SCR-274N, ARC-5, ATA/ARA EQUIPMENT

.19-.55 Mcs. ARA Receiver. New. **\$14.75**
3-6 Mcs. Receiver. Good cond. guar. **4.95**
6-9 Mcs. Receiver. Good cond. guar. **5.95**
7-9 Mcs. Arc-5 Trans. New but not factory packed **9.95**
3-4 Mcs. Arc-5 Trans. Brand new (Average wt. of above items 13 lbs.) **16.95**

The Hiway Policy: 25% DEPOSIT WITH ORDER. Remit in full—SAVE C.O.D. CHARGES. SATISFACTION GUARANTEED OR YOUR MONEY BACK!

HIWAY COMPANY

Electronic Division

1304 S. HOOVER ST.

Just S. of Pico

(Fitzroy 0343)

LOS ANGELES 6, CALIFORNIA

Send for our FREE catalogue!

set to be turned to any desired direction for better viewing of programs.

The "Tele-Turn" is placed centrally under the receiver and a feather-touch rotates the set gently in any desired direction. As the unit is constructed from heavy gauge steel, the largest and heaviest sets can be supported on it, and it is also adaptable for use under heavy ham equipment.

RECORD-O-FONE

The manufacture and distribution of a new "tape recorder" has been announced by *Bell Sound Systems, Inc.*, 555 Marion Road, Columbus 7, Ohio.

This unit, to be sold under the name of "Record-o-fone," is suited for true-tone reproduction of musical instruments, singing and speaking voices, or radio program recording, and is capable of picking up any sound audible to the ear. It records one-hour-length tape reels that can be played (Continued on page 103)

"ESFETA" ELECTIONS

THE first annual meeting of "ESFETA" (Empire State Federation of Electronic Technicians' Association) was held April 24 at the Hotel Arlington, Binghamton, N. Y. Delegates were present from ARSNT, New York City; RTG, Rochester; Southern Tier Chapter R.S.A., Binghamton; Central N. Y. RTG, Ithaca; Hudson Valley R.S.A. of Poughkeepsie, and the newly-formed Endicott Radio and Television Association.

At the Annual Meeting, Max Leibowitz, ARSNT, New York City, was elected president; Miss Margaret Snyder, RTG, Rochester, vice-president; Wayne Shaw, Southern Tier Chapter, R.S.A., Binghamton, secretary; Ben DeYoung, Central N. Y. RTG, Ithaca, treasurer; and Arthur J. Blakely, Radio-Television Servicemen's Ass'n. of Corning, sergeant-at-arms.

The officers of the ESFETA present a rather unique group. They are all full-time radio service technicians; even Miss Snyder is included in that classification. She has had a goodly amount of experience in her father's service department.

Any technicians' association in New York State is eligible for membership in ESFETA, and the Empire State organization extends an invitation to them all to come to any of its gatherings.

Annual reports were turned in on the various local organizations. Endicott Radio-Television Association has elected Richard Wheat as president; with Ernie Marshall as vice president; Richard K. Newcombe, secretary; and Walter Porznick, treasurer. The Long Island Television and Radio Technicians Guild announces that at its recent meeting Gene Laper was elected president, and John A. Wheaton, corresponding secretary. The newly-christened Corning Area Radio and Television Technicians Guild elected Arthur J. Blakely for president and Andrew M. Mertson as secretary. Re-elected as president of the Radio Technicians Guild of Rochester was T. Lawrence Raymo. Robert A. Bryan, Sr., was chosen as vice president; Donald Lissow as secretary; and William A. J. Frenzel was re-elected treasurer.

6 POPULAR RECORD CHANGERS-TAKE YOUR PICK \$12.95 TWO FOR \$25.00

9000 brand new and factory cartoned record changers for sale at an all time low price. Six of our most popular sellers and changers you have used before and will recognize by their names, better rush your order in now, they won't last long at this \$12.95 two for \$25.00 price.

CRESCENT Model 350A Size 1 1/2x1 3/4 \$12.95 Two for \$25.00	AERO AERO-Stewart Warner Permanent Needle Size 12x13 \$12.95 Two for \$25.00	DETROLA Ever popular Detrola. Size 1 1/2x1 3/4 \$12.95 Two for \$25.00	GENERAL INST. Small Size 10 1/2x12 \$12.95 Two for \$25.00	VM-800 Size 1 3/4x1 1/4 a scoop at only \$12.95 Two for \$25.00	CAPEHART Don't pass up this super scoop in a two post genuine Capehart record changer. Brand new but may need minor adjustment, super heavy duty construction, with Capehart true timber. Variable resistance high fidelity cartridge. Requires same turn as a General Electric V.R. Base size 1 1/4x1 1/4. Capehart super scoop \$12.95 Two for \$25.00
--	--	--	--	---	--

DELCO TUBE SCOOP!

59c Each, 10 for \$5.50

We made a lucky purchase of genuine Delco radio tubes bulk packed, latest product.

125A7gt	50L6gt
125K7gt	35L6gt
125Q7gt	

AMERICAN BEAUTY \$4.95

American Beauty Radio type soldering iron with removable set screw tip. Brand new, factory cartoned with stand. 150 Watt. Standard radio size. Scoop price \$4.95.

KARAOKE 6 TUBE WITH 3 GANG TUNING CONDENSER RF STAGE

A.V.C., compact construction for custom installation, size 8x8x5. No speaker furnished, use dash of car. Furnished with control cable and Crow drive parts. You may use any standard Crow thru '49 model cars. Karadio model 1275 weight 12 lbs., less speaker and less panel kit but with Crow drive kit, net \$30.54. Karadio model 1275 with under dash panel kit \$32.95. Karadio model 1275 with any Crow custom panel kit '41 thru '49 net \$34.95. Above prices less speaker.

GENERAL ELEC. YGA-4 AUDIO OSCILLATOR \$24.95

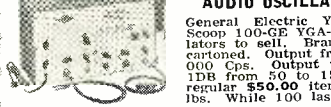

General Electric YGA-4 Sine or Square wave, \$59.95. 30 to 500 cycles per second. Made to sell for \$150.00. Frequency range 20 to 20,000 Cps., either sine or square wave at a flip of a switch. Ideal for schools and sound men. Weight 40 lbs. Scoop price \$59.95.

EXTRA TONE ARM WITH CRYSTAL CARTRIDGE-\$1.50 EXTRA

Extra tone arm with crystal cartridge-\$1.50 extra. G.E. RFX10 Variable Reluctance Cartridge \$2.95 extra.

100 RADIO TUBES \$29.95

250,000 Tubes for fast sale. Tremendous value. Tubes up to \$3.00 list. 100 Cartoned and branded Hyvac Miniature Tubes for \$29.95. Over a million sold. Guaranteed full replacement. 5c each in smaller quantities.

1R5	12BE6	12A6	6SU7	125B8
1T4	12AT6	12BF6	6AQ5	9001
1T5	35W4	6A06	6A08	9002
155	50B5	6BE6	6C4	6BM6
155	50B5	6AT6	6X4	11723
3V4	12AR7	6A5	6W4	1A7B3
3Q4	12AU7	6AR5	6AG5	6B8
354	12AX7	6BF6	6AU6	6Y6
12BE6	12BA7	6AU7	6EG6	

Popular GT Tubes, individually cartoned and branded Hyvac. \$35.00 per hundred. 39c each in smaller quantities.

6V6	6X5	6SK7	125F7	12SN7	32L7
6SN7	6SD7	6S07	6J5	12BF7	
6C5	6Y3	25L6	6S7J	6S7Z	
6B5	6K7	70L7	125J7	35Z5	
12A8	6Y3	1B4	6S7F		
658	6K6	12K8	80		
1258	6SA7	12A6			

HYVAC 6A5 AND 6J6 59c EACH

STANDARD RADIO TUBES CARTONED and UNCARTONED 49c

024G	166	5V4	6F7	6SA7	6T7	788	757	12F5	125L7	2525	3525	77
1A4	1H6	5Y3	6H6	6SD7	6V6	704	7V7	12H6	125N7	2526	38	78
1A6	1H6	6A3	6J5	6C07	6X5	705	7Y4	12J5	125Q7	26	39	80
1B4	1L4	6AB7	6J7	6SF5	6Y6	706	7Z4	12K6	125R7	27	42	
1B5	1R5	6C7	6K5	6SF7	6Z7	707	10Y	12L7	125S7	30	4525	
1C6	1S5	6AG7	6K6	6SG7	6Z7	708	12M6	12S7	14A7	32	50B5	
1C7	1T4	688	6K7	6SH7	7A4	7E7	12A8	12S7	14B6	33	50L6	
1D5	1V4	6C4	6K8	6S7	7A5	7F7	12AH7	12S7	14C7	34	5066	
1D7	2A5	6C5	6L5	6S07	7A6	7H7	12AT6	12S7	14H7	35	57	
1D8	2A6	6C6	6S7	6S17	7A7	7J7	12B6	12S7	14J7	36	58	
1F4	2A7	6D6	6N7	6S07	7B4	7N7	12B6	12S7	14K7	37	59	
1F5	3A4	6D8	6R7	6SR7	7B5	7O7	12B6	12S7	14L7	38	59	
1G4	5T4	6F5	6S7	6S57	7B6	7R7	12C8	12S7	14M7	39	59	

NAME BRAND 1 1/2 VOLT LOCALS, ETC.

1LN5	1LD5	1LH4	1LC5	1LA6	1LB4	69c	10 for \$6.50
1LC5	1L5	3LF4	1L3	1L4	1L5	69c	
1A7	1N5	1A5	1N5	1G5	1T7	69c	
024	69c Each, 100 for \$59.50	35A5	50A5	69c Each.			

HOT ITEM-AUTO SPEAKERS

MAGNAVOX	UTAH
6" Square 4 OHM	\$1.49
6" Round 4 OHM	1.49
6" Auto Speaker 4 OHM	1.98
7" Motola-Philco	2.49
8" Motola-Philco	2.49

HEAVY DUTY AUTO P.M.s

Heavy duty PM speakers with 3/4 inch voice coils and 3.16 oz. Alnico V magnet. Made by a top flight manufacturer this year for auto radio replacements.

6 inch 3.16 oz. Alnico V.P.M.	\$2.49
6 inch 3.16 oz. Alnico V.P.M.	2.98
7 inch 3.16 oz. Alnico V.P.M.	2.98
8 inch 3.16 oz. Alnico V.P.M.	2.98

Save Up To 50% On Cinaudagraph Field Coil Speakers

Rear heavy stock of field type Cinaudagraph Replacement speakers. Brand new, individually cartoned. Don't pass up this value.

3" 450 Ohm Field Cinaudagraph	\$1.79
4" 4 Ohm Field (Auto) Cinaudagraph	1.79
4" 450 Ohm Field Cinaudagraph	1.79
4" 450 Ohm Field Cinaudagraph	1.79
4" 450 Ohm Field Cinaudagraph	1.99
6" 1000 Ohm Field Cinaudagraph	1.99
8" 1000 Ohm Field Cinaudagraph	2.49

Wagner Nichols Micro-Groove Recorder \$89.95

Now you can buy a Micro Groove Recorder. Made by Wagner-Nichols. Cuts 500 lines to the inch. A 15 minute record may be made on a 4" thin plastic disc. Good tone quality, powerful playback amplifier. This is the recorder of the future. Amplifier has connections for external speaker. Priced complete with microphone and 12 recording blanks. Net Price \$89.95. Extra blanks \$1.39 per dozen. Wagner-Nichols Micro Groove Recorder Stock No. WX-34. Net \$89.95.

12" P.M. FOR UTILITY USE

Nationally known 12" 6.8 ohm. Alnico V PM with 1" 8 ohm voice coil. 15 Watts. Grey finish. Our leading 12" speaker. Stock No. CH-12. Net \$4.95. 5 for \$22.50

McGEE HAS THE SPEAKERS

Following speakers listed are latest production factory throwouts made by the original equipment to America's biggest Radio Factory. Every speaker guaranteed.

3" PM 1 Oz. Alnico 5 Magnet	\$0.99
4" PM 1 1/2 Oz. Alnico 5 Magnet	1.19
4" PM 1 1/2 Oz. Alnico 5 Magnet	1.19
5" PM 1 1/2 Oz. Alnico 5 Magnet	1.19
6" PM 1 1/2 Oz. Alnico 5 Magnet	1.98
6" PM 3.16 Oz. Alnico 5 Magnet	2.49
6 1/2" PM 1.5 Oz. Alnico 5 Magnet	1.69
4 1/2" PM 1.5 Oz. Alnico 5 Magnet	1.49
10" PM 4.64 Oz. Mag.	3.98
Hot Buys In PM's-With Trans.	
4" PM 1 Oz. Alnico 5 2500 Ohm Trans.	\$1.49
5" PM 1 1/2 Oz. Alnico 5 2500 Ohm Trans.	1.69
6" PM 1 Oz. Alnico 5 1000 Ohm Trans.	1.69
5 1/2" PM 1 Oz. Alnico 5 2500 Ohm Trans.	1.89
6" PM 1.5 Oz. Alnico 5 7000 Ohm Trans.	1.99
6" PM 1.5 Oz. Alnico 5 2500 Ohm Trans.	1.99
6" PM 2.15 Oz. Alnico 5 7000 Ohm Trans.	2.49
6" PM 3.16 Oz. Alnico 5 1000 Ohm Trans.	2.98
5" 450 Ohm with 2500 Ohm Trans.	1.98
5" 450 Ohm with 7000 Ohm Trans.	2.29
6" 450 Ohm with 7000 Ohm Trans.	2.98
8" 1000 Ohm. Less Trans.	2.49
10" 1000 Ohm. Less Trans.	4.98
12" 450 Ohm. Less Trans.	4.98
12" 1000 Ohm Magnavox. Less Trans.	4.98

SALE! NATIONAL UNION

ORDER \$100.00 WORTH OF N.U. COND.—TAKE 10% OFF
100,000 FOR SALE AT OVER 1/2 SAVING. PLENTY OF EACH SIZE.

We bought the entire stock of National Union Electrolytic Tubular Condensers, Tubular By-passes, and Sav-A-Shaft Vacuum Controls. Stocking up while pickings are good. All National Union products are made by the latest 1948 production by a Number One builder of Electrolytics. Guaranteed by us for a period of one year. You must be satisfied with the merchandise we ship you. Order \$100.00 worth of these N. U. Condensers and take 10% off of price.

TYPE "AT" N.U. TUBULAR ELEC. ALUMINUM WITH SEALED ENDS

National Union Type AT Electrolytic sleeves. Bare wire leads. Standard package of 10 condensers. This is your every day condenser.

AT 10 MFD.	25 Volt	11/16x1 3/4"	20c	AT 4 MFD.	450 Volt	13/16x1 3/4"	20c
AT 25 MFD.	25 Volt	11/16x1 3/4"	20c	AT 8 MFD.	450 Volt	13/16x1 3/4"	30c
AT 50 MFD.	25 Volt	11/16x1 3/4"	20c	AT 10 MFD.	450 Volt	13/16x1 3/4"	30c
AT 100 MFD.	25 Volt	11/16x1 3/4"	25c	AT 12 MFD.	450 Volt	13/16x1 3/4"	30c
				AT 16 MFD.	450 Volt	13/16x1 3/4"	35c
				AT 20 MFD.	450 Volt	13/16x1 3/4"	40c
				AT 25 MFD.	450 Volt	13/16x1 3/4"	40c
				AT 30 MFD.	450 Volt	13/16x1 3/4"	40c
				AT 40 MFD.	450 Volt	13/16x1 3/4"	40c
				AT 50 MFD.	450 Volt	13/16x1 3/4"	40c
				AT 60 MFD.	450 Volt	13/16x1 3/4"	40c
				AT 80 MFD.	450 Volt	13/16x1 3/4"	40c
				AT 100 MFD.	450 Volt	13/16x1 3/4"	40c
				AT 120 MFD.	450 Volt	13/16x1 3/4"	40c
				AT 160 MFD.	450 Volt	13/16x1 3/4"	40c
				AT 200 MFD.	450 Volt	13/16x1 3/4"	40c
				AT 250 MFD.	450 Volt	13/16x1 3/4"	40c
				AT 300 MFD.	450 Volt	13/16x1 3/4"	40c
				AT 400 MFD.	450 Volt	13/16x1 3/4"	40c
				AT 500 MFD.	450 Volt	13/16x1 3/4"	40c
				AT 600 MFD.	450 Volt	13/16x1 3/4"	40c
				AT 800 MFD.	450 Volt	13/16x1 3/4"	40c
				AT 1000 MFD.	450 Volt	13/16x1 3/4"	40c

TYPE "CT" ELECTROLYTICS

National Union Type CT Cardboard tubular with wax seal and mounting strap. Flexible leads. Individually cartoned in green N.U. boxes. A red hot value at over 1/2 saving. One-year guarantee.

CT16-16 MFD.	150 Volt	1 1/2x2 3/4"	25c	CT16-16 MFD.	150 Volt	1 1/2x2 3/4"	25c
CT20-20 MFD.	150 Volt	1 1/2x2 3/4"	30c	CT20-20 MFD.	150 Volt	1 1/2x2 3/4"	30c
CT25-25 MFD.	150 Volt	1 1/2x2 3/4"	35c	CT25-25 MFD.	150 Volt	1 1/2x2 3/4"	35c
CT30-30 MFD.	150 Volt	1 1/2x2 3/4"	35c	CT30-30 MFD.	150 Volt	1 1/2x2 3/4"	35c
CT40-40 MFD.	150 Volt	1 1/2x2 3/4"	40c	CT40-40 MFD.	150 Volt	1 1/2x2 3/4"	40c
CT50-50 MFD.	150 Volt	1 1/2x2 3/4"	40c	CT50-50 MFD.	150 Volt	1 1/2x2 3/4"	40c
CT60-60 MFD.	150 Volt	1 1/2x2 3/4"	40c	CT60-60 MFD.	150 Volt	1 1/2x2 3/4"	40c
CT80-80 MFD.	150 Volt	1 1/2x2 3/4"	60c	CT80-80 MFD.	150 Volt	1 1/2x2 3/4"	60c
CT100-100 MFD.	150 Volt	1 1/2x2 3/4"	60c	CT100-100 MFD.	150 Volt	1 1/2x2 3/4"	60c
CT120-120 MFD.	150 Volt	1 1/2x2 3/4"	60c	CT120-120 MFD.	150 Volt	1 1/2x2 3/4"	60c
CT160-160 MFD.	150 Volt	1 1/2x2 3/4"	60c	CT160-160 MFD.	150 Volt	1 1/2x2 3/4"	60c
CT200-200 MFD.	150 Volt	1 1/2x2 3/4"	60c	CT200-200 MFD.	150 Volt	1 1/2x2 3/4"	60c
CT250-250 MFD.	150 Volt	1 1/2x2 3/4"	60c	CT250-250 MFD.	150 Volt	1 1/2x2 3/4"	60c
CT300-300 MFD.	150 Volt	1 1/2x2 3/4"	60c	CT300-300 MFD.	150 Volt	1 1/2x2 3/4"	60c
CT400-400 MFD.	150 Volt	1 1/2x2 3/4"	60c	CT400-400 MFD.	150 Volt	1 1/2x2 3/4"	60c
CT500-500 MFD.	150 Volt	1 1/2x2 3/4"	60c	CT500-500 MFD.	150 Volt	1 1/2x2 3/4"	60c
CT600-600 MFD.	150 Volt	1 1/2x2 3/4"	60c	CT600-600 MFD.	150 Volt	1 1/2x2 3/4"	60c
CT800-800 MFD.	150 Volt	1 1/2x2 3/4"	60c	CT800-800 MFD.	150 Volt	1 1/2x2 3/4"	60c
CT1000-1000 MFD.	150 Volt	1 1/2x2 3/4"	60c	CT1000-1000 MFD.	150 Volt	1 1/2x2 3/4"	60c

N.U. THREAD MOUNT ALUMINUM CAN TYPE SC

National Union Type SC-SCN-SCS Upright Aluminum Can Condensers. With pat nut mounting. Flexible insulated leads. Individually cartoned in green N.U. boxes. Save over half on this. One-year guarantee.

SC 4 MFD.	450 Volt	1 3/8x3 1/4"	25c	SCN 8 MFD.	450 Volt	1 3/8x3 1/4"	35c
SC 8 MFD.	450 Volt	1 3/8x3 1/4"	30c	SCN 16 MFD.	450 Volt	1 3/8x3 1/4"	50c
SC 16 MFD.</							



Hallcrafters

MODEL S-56 \$110.00 VALUE FM/AM CHASSIS \$59.95

11-TUBE S-56 \$59.95 • PUSH PULL WIDE RANGE AUDIO • AUTOMATIC FREQUENCY CONTROL ON F.M.

Model S-56 Hallcrafters, high fidelity, 11 tube AM-FM radio receiver chassis for broadcast and FM 88 to 108 mc. Automatic frequency control on FM, holds the receiver in perfect tune. Phono connection on rear of chassis. Full range tone control with base boost. Push-pull 6K6 tubes in audio system. Frequency response essentially flat, from 50 to 14,000 CPS. Wide vision accurately calibrated slide rule dial, with pre-selection on broadcast band. Output transformer matches 500 ohm line. 4 antenna terminals; two for AM and two for FM. This is the finest type home radio that we know of today. Better get your order in early. Designed to be used in commercial radios selling in the \$400.00 to \$600.00 class. The regular dealers net on this chassis is \$110.00. However, a lucky purchase enables us to offer these brand new, factory cartoned S-56 Hallcrafters chassis, complete with tubes and operation instructions, at only \$59.95, less speaker. Speaker matching transformer 500 ohm to voice coil \$2.50 extra. Chassis size 2 3/4" x 10" x 7 9/16". Weight 25 lbs. Brand new factory cartoned. Buy your S-56's with a wide range PM speaker. Pick your combination from the prices listed below and save.

S-56 WITH 12" 21 OZ P.M. \$74.95

Hallcrafters S-56 chassis with tubes, 500 ohm to speaker matching transformer and our model A-50 super heavy duty 12 inch 21 oz. alnico V PM speaker (regular \$50.00 list). This gives you the complete radio for custom installations. Shipping weight 38 lbs. Stock No. S-56A50; A-50 Speaker S-56 and transformer all for \$74.95.

S-56 WITH 12" COAXIAL P.M. \$71.95

Hallcrafters S-56 chassis with tubes, 500 ohm to speaker matching transformer and our model CR-13X 12 inch coaxial PM wide range speaker. This gives you a complete radio for custom installations. Shipping weight 38 lbs. Stock No. S-56CR13X; CR-13X speaker S-56 and transformer all for \$71.95.

S-56 WITH 15" JENSEN P.M. \$79.95

Hallcrafters S-56 chassis with tubes, 500 ohm to speaker matching transformer and model A-15 PM Jensen 15 inch 6 lb. magnet speaker. This gives you a complete radio for custom installations. Shipping weight 47 lbs. Stock No. S-56A15PM; Jensen Speaker S-56 and transformer all for \$79.95.

WALNUT ARM CHAIR CABINET FOR S-56 HALLCRAFTERS \$29.95

Walnut arm chair cabinet ready cut to fit the S-56 Hallcrafters radio chassis. 24" high, 16 1/2" deep and 27" wide. Hinged lid covers 14x14 changer compartment. Buy this cabinet with your S-56. Baffle cut for 12" speaker will not hold 15" speaker. Weight 40 lbs. Stock #AR-26, net \$29.95. Walnut arm chair cabinet with uncut panel. Stock #AR-15, net \$29.95. Blond arm chair cabinet with uncut panel. Stock #AR-16B, net \$34.95. General Instrument dual speed 3 1/2 and 7 1/2 RPM automatic record changer. Stock #GI-73. \$17.95 extra.

HALLCRAFTERS S-59 8 TUBE F.M./A.M. CHASSIS SCOOP! \$32.95

Model S-59 Hallcrafters, high fidelity, 8 tube FM-AM radio chassis, for custom installations. Size 2 1/2" x 10 1/2" x 8 1/2". An excellently engineered chassis for radio sets of the \$300.00 class. Receives broadcast 540 to 1700 kc and FM 88 to 108 mc. Accurately calibrated slide rule dial. Variable tone control. Frequency response 60 to 14,000 CPS. Push-pull 6K6 audio system. Output transformer matches 500 ohm line. A terrific value at only \$32.95. Price complete with tubes, but less speaker. Brand new factory cartoned. Weight 16 lbs. Net \$32.95. Line to voice coil matching transformer, \$1.95 extra. 500 ohm to V.C. Trans \$1.30. 500 ohm to V.C. Trans \$1.30. Scoop Price \$49.95.

G.I. DUAL SPEED CHANGER WHEN PURCHASED WITH S-56 OR S-59 \$17.95

General Instrument Dual speed automatic record changer plays 10-12" or 12-10" 33 1/3 or 78 RPM records automatically. Latest model with auto reverse turning on Permanent record. While our stock lasts we offer this changer. Stock #GI-73 for only \$17.95 when purchased with S-56 or S-59 Hallcrafters or \$19.95 when purchased by itself. Weight 11 lbs.

NEW WEBSTER CHICAGO CHANGERS

Model 77-1—2-speed 7" Record Changer. Net... \$16.40
Model 346-1—3-speed All Sizes Record Changer... 30.22
Model 356-1—3-speed All Sizes Record Changer... 33.59
Spider to convert to 7 1/2 RPM Record to standard 4 1/2 hole size. 10 for 25c.
VM Corp. Model 406 Tri-O-Matic Changer. Net... 33.90

NUCLEAR "SNIFFER" GEIGER COUNTER \$54.50

Nuclear "Sniffer" made by a leading manufacturer of nuclear instruments for locating radio-active materials. This small Geiger counter weighs only 2 lbs., powered by 2 standard flashlight batteries furnished complete with light weight headphones ready to sniff out radio-active material. Stock No. ATO-1. Shipping weight 4 lbs. Net, \$54.50.

BUILD A RADIO WITH MATCHED "DETROLA" PARTS 6-TUBE 2-BAND KIT \$16.95

A complete kit of parts, tubes and ready punched chassis to build a fine 6 tube power transformer type radio chassis. (No cabinet.) We furnish every piece as well as a printed diagram and photograph. Chassis size 1 4/8" x 7". Receives standard broadcast and 6 to 18 MC foreign short wave. 3 gang tuning condenser used on both bands. 90 mill power transformer. 6V6 output tube. Heavy duty 8 inch speaker. This kit includes all of parts intended for use in a high quality Detrola radio. Has full lighted slide rule dial. Everything goes together just like a factory built radio. Priced complete with 6 tubes in model 6-AC. Weight 16 lbs. Net \$16.95.

Kit model CD-8. Same basic design as the above model 6-AC except it is an 8 tube AC-DC circuit with 25L6 tubes in the audio. Weight 15 lbs. Priced complete with tubes net \$16.95.

BUILD THIS 8-TUBE HI FIDELITY RADIO AND AMPLIFIER

• 8-INCH SLIDE RULE DIAL • RECEIVES BROADCAST AND 19 to 49 METERS • PUSH PULL OUTPUT TUBES • BASS BOOST TONE CONTROL • EVERYTHING FURNISHED • CHASSIS SIZE 9 1/2 x 11 x 8" HIGH • BEST RADIO KIT VALUE IN THE WORLD



Here is something new in radio. A real 15 watt power amplifier with bass and treble controls. Has extra gain stage for crystal or dynamic mikes. And on the same chassis, a standard speaker pickup. We furnish all parts, knobs, oscilloscope plate and tubes: 6SA7, 6SK7, 6SR7, 6SN7, 6SJ7, two 6V6 and 5Y3. No cabinet. Extra care in designing the power supply section assures low hum level, making this unit ideal for recording as well as P.A. use. We furnish recording as well as schematic diagram and photos of the completed chassis. Weight 26 lbs. PRK-24. Radio-Amp. Kit with 12" P.M. speaker. With tubes \$29.95. PRK-15. Extra large speaker kit as the PRK-24 kit, except it is furnished with 12" Cintragraph wide range speaker. (Has built-in high frequency tweeter. Net \$37.95. This is our finest kit.

COMPLETE RADIO KITS \$6.95 UP

Kit Model X-45 \$14.95. Complete Personal Portable Radio Kit Model X-45. Made from genuine Garod factory matched parts. A complete kit to build a broadcast battery operated 4 tube receiver. Small in size 6 1/2" x 4 1/2" x 4 1/2". Weight 3 1/2 lbs. 2 Gang Superhet circuit set comes on when lid opens. Rugged metal case with colored plastic front and back. Loop antenna in lid. Furnished with diagram and photos of tubes and parts. BATTERY. Will go together like a factory built radio. Shipping weight 6 lbs. Net \$14.95. Kit Model DE-6X \$6.95. Complete Mike Broadcaster Kit Model DE-6X. Broadcasts 800 to 1500 KC from either a phonograph pick up or mike. Makes any radio receiver a P.A. system or recording amplifier. Broadcast tone quality. Has fader control from mike to record simulating a regular broadcast station. Works on 110V. AC-DC. Ready punched chassis. Price includes a wiring diagram, photos and tubes. 2-35Z5, 12SQ7, 35W4. Kit Model DE-6X. Weight 4 lbs. Net \$6.95. Crystal Mike and desk stand \$4.95 extra.

Kit Model TF-4 \$9.95. Complete Radio Kit Model TF-4. A 4 Tube AC-DC Broadcast TRF Receiver. Ideal for the beginner. 2 Gang Condenser. Ready punched chassis. Alnico V PM Speaker Airplane Dial. Plastic cabinet. Diagram photos and special pictorial diagram for beginners. This is the simplest type radio to wire. Price includes every part and tubes, 12SK7, 12SJ7, 50B5 and 35W4. Kit Model TF-4. Weight 6 lbs. Net \$9.95.

Kit Model TF-6C \$9.95. Complete Radio Kit Model TF-6C. A full size broadcast AC-DC. 2 Gang Superhet. Lighted slide rule dial. 13" wood cabinet with plastic front. Loop antenna. Made from Detrola matched parts. Price includes tubes, diagram and photo. 12BA6, 12BE6, 12AT6, 50B5, 35W4. 5" speaker. Weight 9 lbs. This is an ideal kit for the student. Kit Model TF-6C. \$9.95.

TAPE RECORDER 1 HOUR MECHANISM TWIN CHANNELS SPECIAL \$59.95

Our leader tape recorder mechanism—Size 10 1/2" x 8 1/2" x 7 1/2" weight 16 lbs. Tape speed full 7 1/2 feet per second—two sound channels. One hour with 7" reel, 30 minutes with 9" reel. Bias frequency to erase 50K.C. Twin erase heads, one recording head. Response flat from 60 to 8,000 cps. No-slip and no-tension drive. Made for high fidelity recording and play-back on tape. Furnished complete with suggested diagram and erase coil. Model TP-X. Tape mechanism, \$59.95. Recording Tape 7" Reel, \$2.50.

TELEVISION CHASSIS SCOOP \$59.95

Farnsworth Television Chassis Mode. GV260 partially built up Chassis Size 12x17. Has 3 tubes (Resistor and Ceramic Condensers) no coils or Transformers or 130 small parts. Receives standard broadcast and 6 to 18 MC foreign short wave. 3 gang tuning condenser used on both bands. 90 mill power transformer. 6V6 output tube. Heavy duty 8 inch speaker. This kit includes all of parts intended for use in a high quality Detrola radio. Has full lighted slide rule dial. Everything goes together just like a factory built radio. Priced complete with 6 tubes in model 6-AC. Weight 16 lbs. Net \$16.95.

Kit model CD-8. Same basic design as the above model 6-AC except it is an 8 tube AC-DC circuit with 25L6 tubes in the audio. Weight 15 lbs. Priced complete with tubes net \$16.95.

RECORD PLAYER KITS \$9.95 AND UP

Capitol Portable Case. Deluxe Portable Record Player Kit housed in the attractive Capitol case. Includes all parts and easy to follow diagram. Has 4 Heavy Duty PM 78 RPM Phono Motor. All necessary parts to build a 70L7 type Amplifier. Weight 14 lbs. Model CK-1. Net \$9.95.

Portable Player Kit for L.P. \$19.95. Complete Record Player with wired 4-Tube AC-DC Amplifier. Complete parts shipped separately. 4x6" PM Speaker. Brown leatherette Capitol portable case with chrome trim case. Dust speed phono motor 33 1/3 and 78 RPM. 2 Pickup Arms, LP & Standard. Only a few minutes required for assembly. A fine player to own. Stock No. LP-COS. Net \$19.95. Weight 17 lbs. Model CR-8, same as above only for regular 78 RPM records only. 17 lbs. Net \$14.95.

ST. GEORGE WIRE RECORDER MECHANISM WITH 3-TUBE CONVERTER \$29.95

Less Converter \$22.95. Brand new wire recorder. Fully back mechanism with a tone arm used on the Majestic radio wire recorder. This unit has 78 RPM Turntable for recording on tape from a phono record. Records up to 1 Hour on standard Webster Recording Wire. This wire recording mechanism is offered to you at a fraction of the regular net. Space required, 9x13x3 1/2" below board. Each unit is furnished with a diagram and a diagram to help you wire a 2 Tube Osc. (We furnish special Osc. coil, not small part for oscillator and how to adapt the tone arm to any radio or amplifier. Ready punched for crystal phono pick-up. St. George wire recorder with 3-tube Osc. Coil and diagram. Stock No. X93. Weight 15 lbs. Net, \$22.95. Crystal Pick-up Arm for Playing 78 RPM record, \$2.95 extra. Webster Recording Wire, 15 Min., \$1.30; 30 Min., \$1.95. 1 Hr., \$2.25. Bullet Style Shure Crystal Mike, \$4.95. WIRE RECORDER CONVERTER \$9.95. With this 3-tube converter you can adapt the St. George wire recorder mechanism to any radio or P.A. system. Only 3 connections necessary. Just plug in the phono input of your amplifier and connect to plate of output tube. AC-Transformer construction, gain for mike, 3 position tone arm and changing from recording to play-back. Priced ready wired and tested with instructions and tube 12AX7A-ET. Stock #AG25 Oscillator and 6X4 rectifier. Stock #RR-3, net, \$9.95, when purchased by itself.

ST. GEORGE RECORDER WITH CONVERTER \$29.95. St. George wire recorder mechanism Stock #X-93 and RR-3 converter. Specify combination offer when ordering, both for \$29.95. While our stock lasts we offer you for your S-56 Hallcrafters?

WIRE RECORDER AND 18-WATT P.A. SYSTEM

SALE PRICE \$89.95. Three years of wire recording experience has led us to the development of this combination wire recorder and public address system. Housed in an attractive portable case with a hinged lid on the recorder compartment. Beautiful streamlined plastic case. The 18 watt Hi-Fi amplifier in back panel for mike and accessories. Size 9x13x4 1/2". Includes all 18 watt Hi-Fi amplifier with P.P. 6V6 tubes in output stage and separate 6AQ5 eraser circuit. This new super erase circuit eliminates all 8 bugs in wire recording. 12 inch Alnico V P.M. speaker. Extension speaker Jack. Mike input tone control. Equip with the St. George wire recorder playback mechanism that has 78 rpm turntable and General Electric variable reluctance pick-up. You can record or play phono records. Record from mike. The play back quality is tops. Plenty of volume and good fidelity. This is also a top wire recorder. Unit is completely assembled and ready to operate. Finished with chrome crystal mike and desk stand and 15 minute spool of Webster recording wire. Extra recording wire \$1.30 15 min. \$1.30, 30 min. \$1.95, hour, \$2.25. Model CE-15 Portable public address system and wire recorder shipping weight 38 lbs. Net \$89.95.

McGEE RADIO COMPANY

Prices F.O.B. K.C. Send 25% Deposit with order, Bal. Sent C.O.D. With parcel post orders include postage.

NOW AT OUR NEW AND LARGER QUARTERS 3725 GRAND AVE., KANSAS CITY, MISSOURI

RADIO & TELEVISION NEWS

NATIONALLY FAMOUS 12" COAXIAL P.M. SPEAKER \$12.95



MODEL CR-13X 12" COAXIAL P.M. \$12.95	MODEL 5-15X 15" COAXIAL P.M. \$24.95	MODEL 15-LS 15" 50 WATT P.M. \$16.95	MODEL 15-KR 15" JUKE BOX \$9.95	MODEL A-50 12" 50 WATT P.M. \$14.95
---	--	--	---	---

DELUXE 12" COAXIAL MODEL CR-13X \$12.95

- RESPONSE 40 TO 17,000 C.P.S.
- FINE CONSTRUCTION
- GREY FINISH
- REGULAR \$32.50 LIST

Newly designed by one of America's finest speaker builders. Made for FM and AM high fidelity radios and record players. This speaker is incorporated in a range of the 500 dollar bracket. It has an especially designed 12" 6.8 oz. Alnico V Magnet PM for the low range Woofer and a coaxially built in 3" Alnico V tweeter for the extended high range. The high pass filter is concealed under the pot cover. Just hook to any 8 ohm output transformer. Will work in place of any home radio speaker as most speakers have an 8 Ohm Voice Coil, only 2 wires to connect. Will handle 15 Watts peak. Wide range response 40 to 17,000 Cycles. This speaker should sell for \$35.00. Why buy any ordinary speaker when we offer a 12" Coaxial PM for only \$12.95. Shipping weight 8 lbs. Model CR-13X, \$12.95. Two for \$24.95

STANDARD 12" COAXIAL P.M. CN-12X \$10.95

Standard Model 12" Coaxial PM Model CN-12X. Same as model CR-13X except 4.84 oz. Mag. in woofer response 50 to 17,000 CFS. Will handle 12 Watts Output. Shipping weight 7 lbs. Stock No. CN-12X. \$10.95. Two for \$20.95

15" "KING COAX" P.M. SPEAKER \$24.95

The King Coax. A 21.5 oz. 15 inch Alnico V PM speaker with a built-in high frequency tweeter. Will respond from 40 to 17,000 cycles. This is a ruggedly built speaker with a curvilinear one piece molded cone, built-in high pass filter. Just hook to any 8 ohm output. Built by the maker of our ever popular 12 inch coax model CR-13X. This speaker has a retail list of over \$60.00. We offer you our 5-15X 15 inch coax for only \$24.95. Shipping weight 16 lbs.

15" DELUXE 50-WATT P.M. SPEAKER \$16.95

WITH WIDE RANGE MOLDED CONE
Model 15-LS. 15" 2 1/2 oz. Alnico V Magnet PM Speaker. Will take 35 watts with ease. Thousands of dollars were spent in building the fine tools to produce this speaker. The 8 ohm voice coil is 1 1/2" in diameter and has been heat treated and plastic coated. Constructed to eliminate loose voice coils, wires and warping. Made by a renowned builder of fine speakers. Truly the King of juke box speakers. Shipping weight 14 lbs. Net Price \$16.95. Two for \$32.95

15" JUKE BOX P.M. SPEAKER \$9.95

Model 15-KR—Pre-War or Post-War, you never bought a speaker like this for such a scoop price. Made by a nationally known builder of fine speakers. A full 15" 12 1/2 oz. Alnico V magnet speaker of juke box quality. Has standard 8 ohm voice coil. Will take up to 18 watts average or 25 watts peak. Here is a speaker that will bring out those low notes. Latest 1948 production! Not line through-outs. Every speaker is guaranteed new and perfect. We may not be able to continue this offer for long, so place your order now. Stock No. 15-KR. INCLUDE POSTAGE. Wt. 10 lbs. A \$35.00 value for only \$9.95

50-WATT 12" SUPER HEAVY DUTY P.M. \$14.95

Model A-50—12", 50 watt super heavy duty permanent magnet speaker. Has 1 1/2" 8 ohm treated voice coil and one piece molded cone. Heavy half inch machined pot, with bolt secured 21 oz. Alnico V magnet. Frame is of heavy construction with metal pot cover. Finished in silver-grey enamel. This speaker is the best value possible today. Efficiency is two to three times that of ordinary speaker. Especially recommended for all public address systems and high quality home audio systems. Will handle 55 watts with ease and 80 watts peak or short lengths of time. Its retail value is \$30.00. But, by our large purchase we are able to offer it to you for only \$14.95. Do not confuse this speaker with surplus merchandise. This is the latest production. Model A-50. Shipping weight 13 lbs. Net \$14.95. 2 for \$29.00

5-STATION PUSH BUTTON BROADCAST TUNER KIT \$8.95

A Compact Broadcast AM 5 station push button tuner kit. Designed expressly for use with any of our amplifier kits or any P.A. system. A self powered transformer type AC kit with 5 station push button selector (no condenser gang) loop antenna, 456 IF's—A.V.C. etc. Uses 6BA6-6BE6-6AT6 and 6X4. Kit is so designed that when constructed you just plug into the phone input. Priced complete with diagram, photos and instructions. Weight 5 lbs. Order this when you buy any of our amplifier kits: TM-4, TM-8, TM-12, TM-20, TM-30 or ME-15R. Kit FP-A net \$8.95.

\$59.50 VALUE MUSICAL AMP. \$24.95

8 watt Musical Amplifier. 4 tube AC transformer type. Proper gain for all instrument pickups. Housed in leatherette case with built-in 8" speaker. Gain and tone control. Made by a large music manufacturer, to sell for \$59.50. Stock No. XR-3. Weight 25 lbs. Net Price \$24.95

SUPER DELUXE 30-WATT AMP. KIT \$19.95

A complete kit of parts to build a 30 watt public address amplifier. Newly punched chassis with cover, 100 mill power transformer for 110 watt AC. Inputs for two mikes and crystal or G-E Variable reluctance phono-pick up. Base boost tone control, heavy duty shielded output transformer matches 4 or 8 ohm voice coil. In voice feed back. Everything furnished including easy to follow diagram and tubes: 2-1847, 2-7N7, 2-6L6, 5V4. This kit makes ready saleable amplifier, of commercial quality and appearance. Kit TM-30 weight 25 lbs. Net. \$19.95. With 34 watt wide range high fidelity (20 to 20,000 cps) compound filled output transformer with windings 4-8-16-250-500 ohm add \$5.00.

WIDE RANGE 20-20,000 CPS 20-WATT AMP KIT \$24.95

Why pay \$40.00 to \$60.00 to buy parts for a good audio amplifier? Our engineering department designed this kit to give you 20,000 CPS response and have inputs for any variable reluctance pick up, tuner or mike and retaining crystal pick up cartridge. 3 Tone controls, fader control, high fidelity compound filled output transformer matches 4-8-16 Ohm PM Speakers and 250-500 Ohm lines. Push-pull 6V6 tubes. Gives 15 Watts. This kit is complete with photo, diagram and tubes. 12AX7, 3-6C4, 2-6V6, 5Y3. Handy punched chassis. Everything furnished. Weight 16 lbs. Kit Model ME-16R. Net \$24.95. Custom wired and tested \$10.00 extra. We recommend our CR-13X 12" Coaxial PM Speaker with this kit \$12.95. Kit Model ME-34R. Similar to Kit ME-15R except has 2-6L6 tubes in output giving 34 Watts Audio. Kit ME-34R \$34.95. Weight 25 lbs. Custom wired and tested \$10.00 extra.

CURVELENIER "WIDE RANGE SPEAKER LINE" MOLDED HIGH FIDELITY CONES—6", 8" AND 12" SIZES

Designed to meet the ever-growing demand for finer reproduction of sound. Wide range 6 and 8 inch models offered for the first time. These speakers feature heavier moving parts assembly. One piece molded high fidelity curvilinear cones with 45 M.M. reinforcing dust buttons. This reinforcement adds to the high frequency response and overall speaker efficiency. Cone movement is piston-like with more unified action. Every speaker is guaranteed 8 ohm voice coils with 6.8 oz. Alnico V magnets. Even ordinary radios will sound better with these speakers.

Model 6L-1. Wide range 6 1/2" PM 12 Watt. Shipping weight 4 lbs., response 90 to 12,000 CFS, \$4.95.

Model 8L-1. Wide range 8" PM 12 Watt. Shipping weight 5 lbs., response 70 to 12,000 CFS, \$5.95.

Model 12L-1. Wide range 12" PM 12 Watt. Shipping weight 7 lbs., response 50 to 12,000 CFS, \$7.95.

AMPLIFIER KITS WITH VARIABLE RELUCTANCE INPUTS \$6.95 UP

TM-4—5 WATT KIT \$6.95
Kit Model TM-4. 5 Watt Amplifier Kit. Ideal for beginner construction. Has features of higher priced amplifiers. Inputs for phono pick up or microphone. Compensation for G.E. Variable Reluctance pick up. Push-pull output gives good tone quality. Output to 8 ohm Voice Coil. Variable tone control and fader control. Ready punched chassis. This makes a top quality AC-DC Audio Amplifier. Priced complete with tubes, diagram and photos. 2-50B5, 2-12AX7, plus selenium rectifier. Weight 3 lbs. Stock No. TM-4. \$6.95. Crystal mike and utility desk stand \$4.95 extra. TM-4 custom wired and tested \$3.00 extra.

TM-8—8 WATT KIT \$8.95
Kit Model TM-8. 8 Watt Amplifier Kit for utility use, record playing, or paging. Matched component parts. Ready punched chassis. Variable tone control. One control fades from mike to phono. Input compensation for G.E. Variable Reluctance pick up. Output matches 8 ohm Voice Coil. 75 Mill Power Transformer. Price includes tubes, diagram and photo. Push-pull 6AQ5, two 12AX7, plus rectifier. Kit Model TM-8. Weight 8 lbs. Net \$8.95. Crystal mike and utility desk stand \$4.95 extra. TM-8 custom wired and tested \$3.00 extra.

TM-12—12 WATT KIT \$10.95
Kit Model TM-12. 12 Watt Amplifier Kit. Ideal for a high quality record player as a P.A. System or recording amplifier. Matched components. Ready punched chassis. One control fades from phono to mike. Input compensation for G.E. Variable Reluctance pick up. Kit Model TM-12. 8 ohm Voice Coil. 100 Mill Power Transformer. Complete with tubes, diagram and photos. 2-6V6, 2-7N7, 724. Frequency response 50-20,000. Weight 10 lbs. Net \$10.95. Crystal utility mike and desk stand \$4.95 extra. TM-12 custom wired and tested \$4.00 extra.

TM-20—20 WATT KIT \$15.95
Kit Model TM-20. A high quality 20 Watt Audio Amplifier with 135 Mill Power Transformer and push-pull 6L6's. Inputs for mike or phono pickup. Compensation for G.E. Variable Reluctance pick up. Tone and fader controls. Has heavy duty universal output transformer, to match 4-8-16, 250, 500 Ohm. Ready punched chassis. Price includes tubes, diagram and photos. 2-6L6, 2-7N7, 724. Frequency response 50-20,000. Weight 20 lbs. Net \$15.95. TM-20 custom wired and tested \$5.00 extra.

CAPEHART 2-POST CHANGER SCOOP!—\$12.95

\$9.95 WHEN PURCHASED WITH AMP. KIT
This super constructed Capehart 78 RPM automatic record changer was used on the finest phono combinations. Size 14 1/2 x 1 1/2 weight 23 lbs. True timber wide range cartridge with needle requires same gain as G.E. Variable reluctance. New except removed set to be replaced with twin speed changer. Extra plate stage already built in our TM-4, TM-8, TM-12, TM-20, TM-30 and ME-16R amplifier kits. Buy this with any of these kits at \$4.67. Lucky purchase by us enables this low price of only \$2.95. Packed 12 to a master carton. Better stock up now. Kits to build a G.E. type pre-amplifier with wiring diagram and 6SC7 tube. \$2.45

G.E. RFX010 VARIABLE RELUCTANCE CARTRIDGE! \$2.95

The widely publicized and nationally advertised General Electric RFX-010 Variable Reluctance pick-up Cartridge for standard 78 RPM Records. Permanent sapphire needle. Made to sell to the dealer at \$4.67. Lucky purchase by us enables this low price of only \$2.95. Packed 12 to a master carton. Better stock up now. Kits to build a G.E. type pre-amplifier with wiring diagram and 6SC7 tube. \$2.45

OUTPUT TRANSFORMER HIGH FIDELITY 20—20,000 C.P.S. SCOOP PRICE

\$6.95 EACH

6600 OHMS PLATE TO PLATE
Why pay \$20.00 or \$30.00 for an output? Supreme quality and high fidelity output transformer. Designed to match push-pull plates (2-6L6, 2-6V6, or 2-6AQ5) class AB to 4-8-16 Ohm and 250-500 ohms with 10% feedback winding. Housed in a compound filled case! Output 1500-2000 cycles. Weight 8 lbs. If you want the best quality from your audio system, order this transformer. Construction essentially flat from 20 to 20,000 cycles. We have tried several high fidelity outputs in our lab and this to be the best value. Even though your amplifier only puts out 10 or 15 watts, this 34 watt output will still have 34 watts of reserve power. Connecting instructions are furnished. Stock No. A-403, shipping weight 8 lbs. Net price \$6.95

40-Watt CAPEHART Wide Range Output Trans. \$7.95

Built for Capehart for this highest combination. 40 watt capacity all windings interwound to increase high frequency response and decrease capacity losses. High inductance in coils makes for best efficiency at low audio frequency. This high fidelity output transformer essential for high fidelity and has a net weight of 6 lbs. Made to match push pull 6L6 tubes 5,000 ohm plate to plate. Has tertiary winding for 100% feedback and coil windings of 4 and 8 ohms. Frequency response plus or minus 2 dB from 100 cycles to 15,000 cycles. 6DB below 20 cycles and above 15,000 cycles. Furnished with connecting instructions. Size 3 1/2 x 4 1/2 x 3 1/2. Shipping weight 8 lbs. Stock No. SX-55 net \$7.95.

CONSOLE BASS REFLEX SPEAKER BAFFLE \$24.95

8 Cubic Foot Utility Base Reflex Speaker Baffle. Size 32x22x18. Heavy construction. Chrome front trim. Shielded against Celotex lining assures non-rattle production. Finish is an utility brown enamel. Chrome front trim. Shipping weight 13 lbs. Net \$24.95. Order this when you buy any of our amplifier kits: TM-4, TM-8, TM-12, TM-20, TM-30 or ME-15R. Kit FP-A net \$8.95.

Astatic MLP-1 \$1.39, 10 for \$12.50

Astatic MLP-1 Cartridge with permanent needle. This model used on many original equipped changers. Priced at below cost of needle. \$2.39; 10 for \$12.50. Astatic MLP-2, same as MLP-1, only later model with QT needle. No surface noise. Sale price, \$1.95. Astatic NJ-Nylon cartridge with permanent, but changeable needle, \$3.29. Astatic QT 3-M cartridge with silent needle response to 10,000 CPS. Reg. \$8.40 list. Scoop price, \$3.29.

3 Cartridges—95% Off Your Need \$1.79 Each, 10 for \$15.00

Astatic L-40 or equal, with rest clip, replaces the following: L-41, L-75, Webster P-5, E-6, F-3, N-3, N-5, or N-7. \$1.79 each; 10 for \$15.00. Astatic L-70 or equal, with rest clip. Replaces the following: L-22, L-24, L-27, L-71, L-76 or Shure P-88, N-8, W-40, W-50, or Webster 1X6, 1X2, N-4, E-4, etc. \$1.79 each; 10 for \$15.00. Astatic L-72 or equal, with rest clip. Replaces the following: L-24, L-46, Shure P-80 and Webster, N165, 3 V. Output that will drive single tale record players and put extra power in any player. The most up to date crystal built. \$1.79 each; 10 for \$15.00.

CAITRON V.R. CARTRIDGE, \$2.95

CAITRON Variable Reluctance Standard size cartridge as used in broadcast stations. Has permanent needle. A \$15.00 cartridge for only \$2.95. GE Variable Reluctance Cartridge RFX-040 with replaceable needle \$5.85. GE RFX-041 1 Mill Micro-Groove \$5.85. Webster M1 Variable Reluctance Cartridge. Small size with replaceable needle. \$4.41. Plastic arm with 3 V. cartridge. \$1.95. 200 complete arm with 3 1/2 V. cartridge. \$2.29. Complete arm with 1 1/2 V. cartridge. \$2.29. L.P. micro-groove arm with needle \$3.95.

PHILCO MIKE SALE BRAND NEW WITH 20 FT. OF CABLE

High imp. dynamic mike made for Philco 605, 20 ft. cable. Reg. \$26.00 list. Sale price \$9.95. 3 for \$26.95. High imp. dynamic mike made for Philco 630, 20 ft. cable. Reg. \$36.50 list. Sale price \$14.95. 3 for \$44.95. High imp. studio velocity. Made for Philco V1, 20 ft. cable. Reg. \$40.00 list. Sale price \$14.95. 3 for \$44.95. High imp. Cardyne dynamic (not pictured). Philco 728. Wide range response. 20 ft. cable. Reg. \$59.50 list. Sale price \$24.95.

McGEE RADIO COMPANY

July, 1949 71

PRICES F.O.B. K.C. Send 25% Deposit with order. Bal. C.O.D. With parcel post orders include postage. NOW AT OUR NEW AND LARGER QUARTERS 1422 GRAND AVE., KANSAS CITY, MISSOURI

Keeping up
with radio



RADIO HANDBOOK

Radio's Outstanding Practical Text



Twelve chapters devoted to fundamentals of radio communication. Six chapters cover practical aspects of communication antennas and transmission lines. One chapter devoted to electrical and mechanical data on rotary arrays alone! Valuable new information on tuning of antenna arrays and on matching the antenna to the feed line.

Eleven chapters of constructional data, on transmitters up to one kilowatt, receivers, broad-band and conventional converters, test equipment, exciters, v.f.o.'s, speech equipment and power supplies.

One chapter is devoted to a compilation of data on the calculation of operating characteristics of all usual types of vacuum-tube amplifiers, including grounded-grid, cathode-follower, and beam tetrode types. One chapter devoted to transmitter design and control principles, with examples of flexible transmitter-control circuits.

BIGGER THAN EVER BEFORE!

\$3.00 AT YOUR DEALER—On mail orders from us, \$3.25 postpaid. Add tax in Cal. Foreign, \$3.50.



ANTENNA MANUAL

The only practical, comprehensive book on antennas. 300 pages of down-to-earth help on antenna, feed line, radiation and propagation for all frequencies up to 1000 Mc. including FM and TV. Plain language; no need to brush up on math. A necessity for everyone interested in transmission or reception.

\$3.50 AT YOUR DEALER—On mail orders from us, \$3.60 postpaid. Add tax in Cal. Foreign, \$3.75.



RADIO AMATEUR NEWCOMER

Ideal for those just getting started (or interested) in radio. You need no other book to get your license and get on the air. How-to-build simple equipment for a complete station; operating instructions; simple theory; study questions needed to pass license exams; U.S.A. Amateur radio regulations. WRITTEN BY THE EDITORS OF "RADIO HANDBOOK."

\$1.00 AT YOUR DEALER—On mail orders from us, \$1.10 postpaid. Add sales tax in California.



SURPLUS RADIO CONVERSION MANUAL IN TWO VOLUMES

This set of reference data has become standard for the most commonly used items of surplus electronic equipment. All conversions have been proven by testing on several units; each yields a useful item of equipment. For list of items covered see ad in February 1949 "Radio News" or write us.

\$2.50 FOR EITHER VOLUME AT YOUR DEALER—On mail orders from us, \$2.60 postpaid.

Geiger Counter

(Continued from page 36)

socket on the chassis, Fig. 6. The tube socket is to be mounted so that the tube will be inserted from the lower side of the shielded type which requires the spring type cap. While a shield is not required from an electrical viewpoint, a portable counter is subject to quite a few jars and jolts and using a shield will insure the tube's being held tightly in its socket.

The wiring diagram for the portable counter is shown in Fig. 7. Wiring may follow the conventional pattern, with the exception of the high-voltage battery leads and connectors. Rubber covered test lead wire will be quite satisfactory for the high-voltage battery connections, with *Amphenol* single prong plugs. A double tie point to which the high-voltage and "B" battery positive leads are connected is secured near the end of the chassis, close to the rubber grommets. A d.p.s.t. power line switch is used for both the filament battery and the high-voltage batteries, which at first glance may seem to be a radical departure from the purpose for which the switch was intended. However, a moment's calculation will show that less than one milliampere of current can flow through the switch, even if the Geiger tube circuit becomes short-circuited. Under normal conditions, the current flowing will be just a few microamperes. It should be noted that the high-voltage side of the switch is to be connected between the negative lead of the battery and the chassis, which eliminates any possibility of a short-circuit between the switch and ground. The foregoing switching arrangement is standard

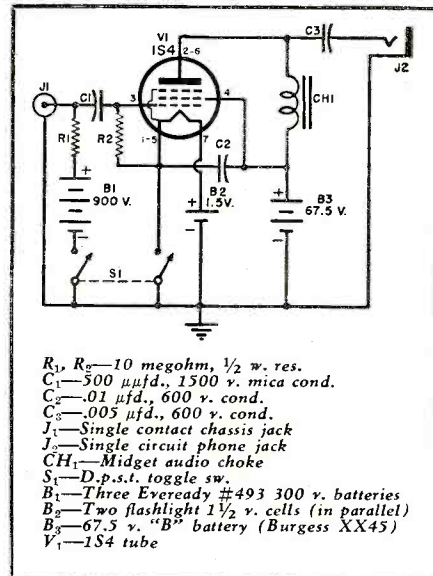

Fig. 7. Complete schematic diagram of the battery operated portable Geiger counter.

practice among many Geiger counter manufacturers and has proven very satisfactory.

All of the parts, including switch, phono jack, and Geiger tube jack should be connected before the chassis is secured to the case, after which it will be an easy matter to insert them in their respective holes and lock them in place.

The filament battery consists of two flashlight cells connected in parallel, with the positive poles connected to the spring brass clips. The negative poles of the cells make contact with the side of the metal case. A more secure contact may be obtained by soldering two clips similar to those mounted on the insulating strip on the end of the chassis, next to the negative side of the flashlight cells.

When the batteries are being placed

Fig. 8. Over-all view of the portable Geiger counter with cover removed.

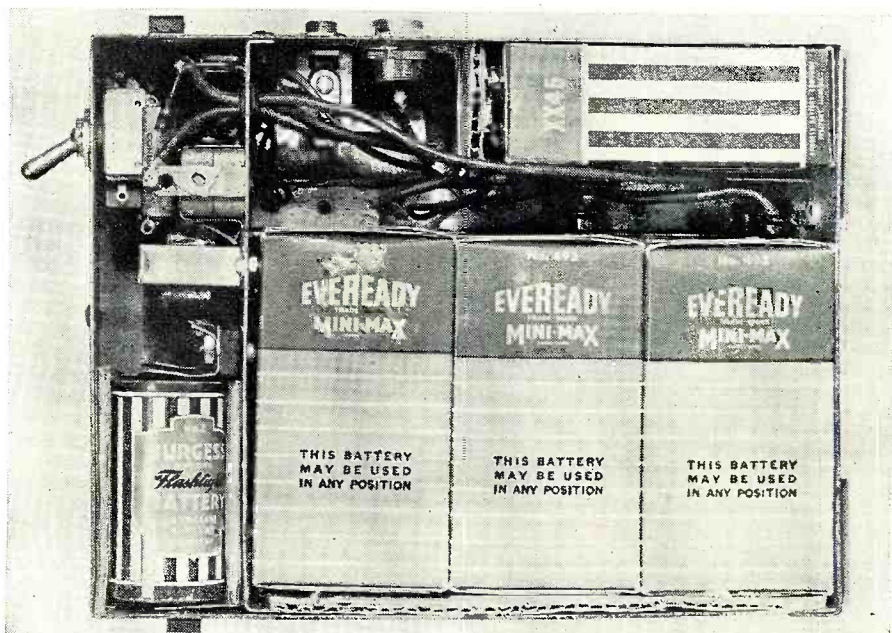

RADIO TUBES at Lowest Prices!

AM, FM, TV—Tremendous Selection of All Types—ORDER TODAY!

29¢ ea.	35W4 01A 4A6G 6A3 6C4 6F8GT	6SD7GT 10 12A 14X7 39/44 47	50 71A 112A 182B 183 25Z6GT	482B 483 1A4 1A6 1B5	1C6 1C7G 1D5GT 1D7 1D8GT 1F4	1F5G 1G4GT 1G6GT 1H4G 1H6GT 1J6G	29¢ ea.		
35¢ ea.	1R5 1S5	1T4 1U4	3A4 3Q4	3S4 3V4	5Y3GT 6S8GT	6SS7 26	27 35Z5GT	35¢ ea.	
39¢ ea.	5Z3 6AC4 6AC5 6AC5GT 6AG5 6AK5 6AL5 6AL6 6AQ5 6AT6 6AU6 6A7 6A8G 6A8GT 6B6 6BA6 6BD6 6BE6 6BH6	6BJ6 6C4 6C5 6C6 6C8G 6D6 6F5GT 6F6GT 6G6 6H6 6H6GT 6J5 6J5GT 6J6 6J7G 6K6GT 6K7GT 6K8GT 6Q7	6Q7GT 6P5GT 6SA7GT 6SC7GT 6SF5GT 6SG7GT 6SH7 6SJ7 6SL7GT 6SK7GT 6SN7GT 6SQ7GT 6SF5 6SG7 6SG7GT 6T7G 6T8 6U7 6W7G 6Y6G 6Z7G 7A4 7A7	6X4 6X5GT 6Z4 12A8GT 12AT6 12AU6 12AU7 12AX7 12BA7 12BA6 12BE6 12F5GT 12H6 12J5GT 12J7GT 12K7GT 12K8GT 12Q7GT 12S8GT	12SA7GT 12SF5 12SF7 12SG7 12SH7GT 12SJ7 12S7GT 12SK7GT 12SN7GT 12SQ7GT 12SR7GT 14X7 2050 2051 24A 25L6GT 25X6 25Z5 25Z6GT	30 31 35 35L6GT 35B5 35C5 35Z3 35Z4GT 36 37 38 39 41 42 43 45 46 50A5 50B5	30 31 35 35L6GT 35B5 35C5 35Z3 35Z4GT 36 37 38 39 41 42 43 45 46 50A5 50B5	39¢ ea.	
49¢ ea.	1A7GT 1C5 1H5GT 1L4 1N5GT 1S4 2A5 3Q5GT 5U4G 5W4GT 5X4 5Y4G	2A5 2A7 2B7 2C34 2E24 5V4 5X4 5Z4 6AC7 6AV6 6B4G	6B7 6C6 6D8 6D8G 6F5 6F8G 6H6 6J7 6K7G 6Q6 6R7	6SF5 6SG7 6SG7GT 6T7G 6T8 6U7 6W7G 6Y6G 6Z7G 7A4 7A7	7B6 7E5 7E6 7E7 7F7 7G7 7H7 7J7 7L7 7N7 7Q7	7S7 7T7 7W7 12A7 12AT7 12C8 12J5 12Q7 12SF7 12SG7 14N7	19T8 20 2050 2051 24A 30 32L7GT 35/51 36 40 50L6GT	50Y6 51 56 57 58 58 71A 75 76 77 78 84/6Z4 85 88 89	49¢ ea.
59¢ ea.	1B3 1AD5 1LA6	1LB4 1LC5 1LC6	1LH4 1LN5 2V3G	3LF4 6B7 6B8	6BG6G 6J8G 6L6G	6L6 6S7G 6U5	12Z3 70L7GT 43	81 11Z6GT	59¢ ea.

5% additional discount for orders of 200 tubes or more assorted
Less than 50 tubes, 5c per tube extra.

Individually boxed—Standard factory guarantee.

SPEAKERS

Best quality Alnico 5 PM Speakers.

10 or more Each	Price Each
3 1/2"	95c \$1.05
4"	
5"	
6"	\$1.49
8"	2.95
10"	4.25
12"	4.95

BY-PASS CONDENSERS

Buy our assortment. **\$5.49**
100 condensers for

.001 mfd. 600 V.	ea. 6c
.002 mfd. 600 V.	ea. 6c
.005 mfd. 600 V.	ea. 6c
.01	ea. 7c
.02	ea. 7c
.05	ea. 8c
.1	ea. 9c

400 VOLT BY-PASS CONDENSERS

.2 mfd.	ea. 9c
.25 mfd.	ea. 10c
.5 mfd.	ea. 15c

BUFFER CONDENSERS

.005 mfd. 1600 WV	15c ea.
.008 mfd. 1600 WV	
.01 mfd. 1600 WV	

SPECIAL SALE!

PILOT LIGHTS—100 bulbs

1 box of 10 bulbs **\$4.90**
54c

No. 40 6-8 Volts .15 Amps. No. 46 6-8 Volts .25 Amps.
No. 41 2.5 Volts .50 Amps. No. 47 6-8 Volts .15 Amps.
No. 44 6-8 Volts .25 Amps. No. 51 6-8 Volts .20 Amps.

AUTO ANTENNAS

Snyder TC-3 Top cowl C-30
any antenna **\$1.99 ea.** Side cowl **\$1.79 ea.**

PICK-UPS

Shure, Astatic—wide response
Finest pickups—standard replacement **\$2.95 ea.**

CRYSTAL CARTRIDGE

Standard replacement crystal cartridge. **\$1.49**

6-Ft. LINE CORDS

Good Rubber with plug. Underwriters' Approved.
10 for **\$1.25** 10 for **\$1.69**

PUSH-BACK WIRE

100 ft. rolls **39c each**

SELENIUM RECTIFIERS

Standard 100 mil. **ea. 69c** 75 mil. **ea. 59c**

GE VARIABLE RELUCTANCE CARTRIDGE

List Price **\$9.95** Your Cost **\$3.68 ea.**

OCTAL SOCKETS

Standard 10 for **49c**

VARIABLE CONDENSERS

Two gang for superhet Standard 1/2" shaft **69c**

OUTPUT TRANSFORMERS

For 50L6, etc. **39c ea.**

For 6V6, 6F6, 3Q5, etc. **45c ea.**

UNIVERSAL OUTPUT TRANSFORMER SPECIAL!

Up to 12 watts to any speaker **\$1.10 ea.**

IF TRANSFORMERS

Standard replacement **ea. 39c**
Specify regular size or midget

VOLUME CONTROLS

1/2 meg.—switch—long shaft **34c ea.**
2 meg. for battery sets, DPST switch—long shaft **34c ea.**

4 PRONG VIBRATORS—VERY BEST BRANDS

Standard replacement—Sensational Value **\$159 ea.**

FILTER CONDENSERS

Very best brands. Fresh stock

8 mfd, 450 V.	ea. 21c	8-8 mfd, 450 V.	ea. 39c	15 mfd, 150 V.	ea. 21c
10 mfd, 450 V.	ea. 24c	10-10 mfd, 450 V.	ea. 43c	16 mfd, 150 V.	ea. 23c
10 mfd, 450 V with 20-20 mfd, 25 V.	ea. 29c	20-20 mfd, 450 V.	ea. 49c	20 mfd, 150 V.	ea. 25c
15 mfd, 450 V.	ea. 29c	15-15 mfd, 150 V.	ea. 29c	30 mfd, 150 V.	ea. 29c
20 mfd, 450 V.	ea. 39c	20-20 mfd, 150 V.	ea. 29c	40 mfd, 150 V.	ea. 29c
30 mfd, 450 V.	ea. 49c	30-30 mfd, 150 V.	ea. 39c	10 mfd, 25 V.	ea. 16c
30 mfd, 450 V with 20-20 mfd, 25 V.	ea. 29c	40-20 mfd, 150 V.	ea. 39c	20 mfd, 25 V.	ea. 16c
		40-40 mfd, 150 V.	ea. 39c	25 mfd, 25 V.	ea. 16c
		50-30 mfd, 150 V.	ea. 39c	100 mfd, 25 V.	ea. 16c
		50-50 mfd, 150 V.	ea. 39c	20-16-16 mfd, 350 V Sprague.	ea. 39c
		60-60 mfd, 150 V.	ea. 39c	25-25-150 V-200-10 V.	ea. 39c

Rated accounts—10 days—all others 20% deposit with order, balance COD. Minimum order \$5.00. All shipments FOB Chicago. Prompt attention paid to foreign orders. ORDER TODAY.

PREMIER RADIO TUBE COMPANY, 1812 Winnemac Ave., Chicago 40, Ill.
"Your Tube Source Since 1926"



There's a CINAUDAGRAPH SPEAKER FOR EVERY PURPOSE!



CINAUDAGRAPH builds speakers with three objectives in mind:

FREE

Just off the press—the brand new CINAUDAGRAPH Catalog. Write Dept. 150R, CINAUDAGRAPH SPEAKERS, 1401 Fairfax Trafficway, Kansas City, Kansas.

1. To offer you the World's Most Complete Line—currently 105 standard models, 2" to 15".
2. To supply you with any specialized unit you require—quickly and economically.
3. To insure flawless performance in every application.

When you buy speakers, always specify
CINAUDAGRAPH... and be sure you're
getting the best!



DIVISION OF AIREON MFG. CORP.
SALES OFFICE and FACTORY 1401 FAIRFAX TRAFFICWAY KANSAS CITY, KANSAS

CANADIAN OFFICE: Charles W. Pointon, Queen at Bay St., Toronto, Ont.
EXPORT OFFICE: 13 E. 40th St., New York, N. Y. Cable ARLAB.

Surplus CLEARANCE Sale!



DYNAMOTOR D-2

D-2 Converts to 110 V AC in ten minutes, diagram included, contains integral gear box having four 1/2" drive shafts turning simultaneously at the following speeds:

4000 RPM—Grinders, buffers, flexible shaft tools, etc.
150 RPM—Wrapping fishing rods, slow speed tools.
25 RPM—Dev. tray rocker for photo darkroom.
5 RPM—Turning barbecue spits, Adv. Disp. Beams. A Thousand Other Uses Around the Work Shop. **\$5.95 NEW**

DYNAMOTOR D-1 D-1 Converts to 110 V AC in ten minutes, diagram included, has shaft with squirrel cage blower, also gear reducer with 2 shafts and pulleys at the other end. 1001 uses. **\$4.95 NEW**

RM-29 PORTABLE FIELD TELEPHONE
An ideal portable field telephone. Complete in a rugged steel case for years of wear. Ringer circuit and TS-13 handset. No leather case to deteriorate. Compact 5"x8"x10"—also used as remote control on SCR-284. Simple two-wire operation. 15 miles distance and upwards. Can be used for television installation, intercom system, construction companies' outside and inside work, etc. Light weight, 13 lbs. Excellent condition. **\$9.95 2 for \$18.95**
SPECIAL LOW PRICE EACH

PLUGS and CONNECTORS 49¢ YOUR CHOICE for only

For the SCR-522..... PLQ-167, PL-172
For the BC-348..... PLQ-103
For the BC-733..... PLQ-254
For 259-F Radio Compass Inverter..... PL-3108-22-4S
For the SCR-274-N.....
PL-147, 148, 151, 152, 153, 154A, 156, 258
For the BC-375..... PL-59, PL-61, PL-64
For the ART-13..... U-8U, U-10U, U-16U
For the ARC-1..... U-15U, U-16U
MC-203A coupling Coax Fittings.....
PL-259A (83-1SP)-UG-21U-UG-22U
M-359 U-11/U
PL-164
AN-3108-28-19P
AN-3108-12S } Combination Male and
AN-3100-12S-33 } Female
PL-63 SO-44 PL-62
PL-56 SO-86

WRITE FOR OUR NEW ILLUSTRATED CATALOG!
Minimum order, \$2.00 ALL PRICES F.O.B. CHICAGO.
20% deposit retained on all C.O.D. orders.
Price subject to change without notice.

NESCORP ELECTRONICS

Division of National Equipment & Supply Co., Inc.
Dept. R, 2635 W. Grand Ave., Chicago 12, Illinois
Phone EVERglade 4-5870

ENGINEERS AT I. R. E. CONVENTION and JOBBERS AT RADIO PARTS SHOW SEE PEERLESS 20-20 TRANSFORMERS PROVEN BEST BY SQUARE WAVE TEST



Photos show square wave response with 11,000 cycle fundamental frequency

Square waves provide the most rigorous test of an audio system and give indisputable evidence on transformer performance. These square wave tests were made under conditions simulating actual transformer operation, that is, square waves were fed from a balanced generator through resistors equivalent to the plate load of the tubes. A non-inductive resistance load was used on the secondary. All transformers were demonstrated under identical conditions. No compensation of any kind was used. A switching mechanism was arranged to give an A-B comparison between any of the transformers. All competitive transformers (as well as the Peerless transformer used) were selected from jobber stock items of leading transformer manufacturers. Only the highest priced "high quality" transformer of each manufacturer was chosen. Equally decisive comparative results were obtained at all other frequencies from 20,000 down to 20 cycles.

Let Peerless figure on all of YOUR transformer requirements.

PEERLESS ELECTRICAL PRODUCTS DIVISION



1161 N. Vine Street, Hollywood 38, Cal.
161 Sixth Avenue, New York 13, N. Y.
FRAZAR & HANSEN LTD.
301 Clay Street, San Francisco 11, Cal.
Exclusive Export Agent

within the case they should be wedged tightly into place and a close inspection should be made to see that none of the screws which hold the parts of the metal case together extend through the battery covers.

In selecting the Geiger tube for the portable counter, the same specifications given for the laboratory tube may be followed, namely, the self-quenching type, operating at 900 volts, and preferably in its own metal probe. Normally, a tube operating in the gamma region will meet the needs of prospectors and experimenters, but Geiger tubes for both gamma and beta rays may be obtained if desired. The tube used in these counters was a type TA-B3-AP with a P4 probe and cord. The two units are priced at \$34.50 and may be obtained from *Technical Associates*, 3730 San Fernando Road, Glendale 4, California.

Some Geiger tube manufacturers may terminate the tube cable in a different type of fitting from the one required to fit into the *Amphenol* chassis jack, but when that occurs the proper *Amphenol* plug may be readily substituted.

The background count of a Geiger tube, that is, those counts due to cosmic radiations, are apt to vary widely with the manufacture of the tube. In any event, the useful counts given off by any specimen will be those per-minute over and above the background count. The generally accepted count of worthwhile uranium ores is anything above 40 counts per-minute.

-50-

MAKE YOUR OWN GROMMETS

NO MATTER how many sizes of grommets there are around, something will always crop up which none of the available sizes will handle. A good way to overcome this difficulty is to keep on hand several feet of the new plastic-insulated wire such as is used in house-wiring. The insulation of this wire is easily stripped off in one piece, and the tube-like plastic insulation can be slit lengthwise and worked into the hole with the edge of the metal going into the slit in the insulation to make a neat grommet. After one or two tries, it becomes easy to figure the proper length needed to make a well-fitting grommet. The number of various sizes possible is almost unlimited. The insulation used on ordinary types of wire is rated at 600 volts, and higher voltage ratings are also available. C.H.W.

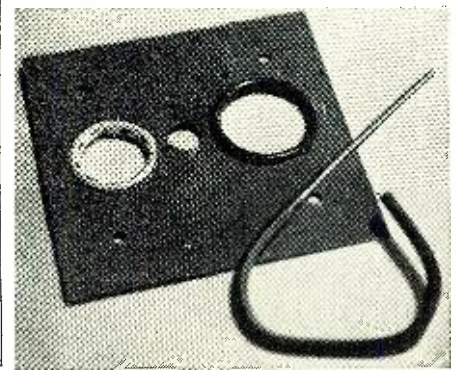



The Sensational Model 70

H F PROBE

Uses the new Sylvania 1N34 Germanium Crystal Diode which combined with a Resistance-Capacity network provides a frequency range of:
300 CYCLES TO 100 MEGACYCLES

SPECIFICATIONS

THE MODEL 70 AS A SIGNAL TRACER

- Locate sources of hum
- Locate cause of distortion
- Locate intermittents
- Make qualitative measurement of signal

THE MODEL 70 CONVERTS YOUR V.O.M. TO A SENSITIVE, NEGATIVE PEAK-READING HIGH FREQUENCY VOLTMETER

- Measure gain and loss in all circuits including T.V.
- Measure ϕ of coils and condensers
- Check capacity and impedance
- Test efficiency of oscillator circuits
- Measure peak voltages of sweep and triggering circuits of T.V. sets
- Measure band-width of T.V. and F.M. sets without complicated test equipment
- Align T.V. and F.M. sets
- Measure frequency by using the probe with coil and condenser

\$3⁹⁵

complete including all instructions

THE NEW MODEL 670

SUPER METER

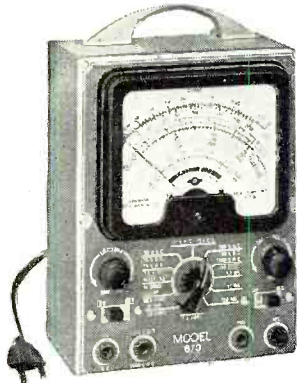

SUPER METER. A Combination VOLT-OHM-MILLIAMMETER plus CAPACITY REACTANCE, INDUCTANCE and DECIBEL MEASUREMENTS.

D.C. VOLTS: 0 to 7.5/15/75/150/750/1500/7500. A.C. VOLTS: 0 to 15/30/150/300/1500/3000 Volts. OUTPUT VOLTS: 0 to 15/30/150/300/1500/3000. D.C. CURRENT: 0 to 1.5/15/150 ma.; 0 to 1.5 Amps. RESISTANCE: 0 to 500/100,000 ohms, 0 to 10 Megohms. CAPACITY: .001 to .2 Mfd., 1 to 4 Mfd. (Quality test for electrolytics.) REACTANCE: 700 to 27,000 Ohms; 13,000 Ohms to 3 Megohms.

INDUCTANCE: 1.75 to 70 Henries; 35 to 8,000 Henries.

DECIBELS: -10 to +18, +10 to +38, +30 to +58.

The model 670 comes housed in a rugged, crackle-finished steel cabinet complete with test leads and operating instructions. Size 5 1/2" x 7 1/2" x 3".

\$2840 NET

The New Model 770—An Accurate Pocket-Size

VOLT-OHM MILLIAMMETER



(Sensitivity: 1000 ohms per volt)

Features:

Compact measures 3 1/2" x 5 1/2" x 2 1/4". Uses latest design 2% accurate 1 Mil. D'Arsonval type meter. Same zero adjustment holds for both resistance ranges. It is not necessary to readjust when switching from one resistance range to another. This is an important time-saving feature never before included in a V.O.M. in this price range. Housed in round-cornered, molded case. Beautiful black etched panel. Depressed letters filled with permanent white, insures long life even with constant use.

Specifications: 6 A.C. VOLTAGE RANGES: 0-15/30/150/300/15000/3000 volts.

6 D.C. VOLTAGE RANGES: 0-7 1/2/15/75/150/750/1500 volts.

4 D.C. CURRENT RANGES: 0-1 1/2/15/150 Ma. 0-1 1/2 Amps.

2 RESISTANCE RANGES: 0-500 ohms. 0-1 Megohm.

The Model 770 comes complete with self-contained batteries, test leads and all operating instructions.

\$1390 NET

THE NEW MODEL 247

TUBE TESTER



Check octals, loctals, bantam jr. peanuts, television miniatures, magic eye, hearing aids, thyratrons, the new type H.F. miniatures, etc.

Features:

- A newly designed element selector switch reduces the possibility of obsolescence to an absolute minimum.
- When checking Diode, Triode and Pentode sections of multi-purpose tubes, sections can be tested individually. A special isolating circuit allows each section to be tested as if it were in a separate envelope.
- The Model 247 provides a super-sensitive method of checking for shorts and leakages up to 3 Megohms between any and all of the terminals.
- One of the most important improvements, we believe, is the fact that the 4-position fast-action snap switches are all numbered in exact accordance with the standard R.M.A. numbering system. Thus, if the element terminating in pin No. 7 of a tube is under test, button No. 7 is used for that test.

Model 247 comes complete with new speed-read chart. Comes housed in handsome hand-rubbed oak cabinet sloped for bench use. A slip-on portable hinged cover is indicated for outside use. Size: 10 3/4" x 8 3/4" x 5 3/4". ONLY.....

\$2990 NET

The Model 88—A COMBINATION

SIGNAL GENERATOR AND SIGNAL TRACER

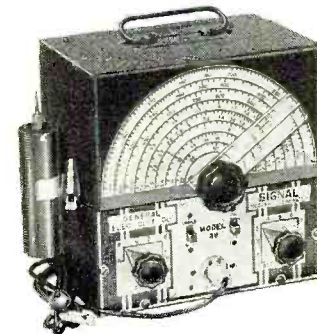

Signal Generator Specifications:

*Frequency Range: 150 Kilocycles to 50 Megacycles. *The R.F. Signal Frequency is kept completely constant at all output levels. *Modulation is accomplished by Grid-blocking action which is equally effective for alignment of amplitude and frequency modulation as well as for television receivers. *R.F. obtainable separately or modulated by the Audio Frequency.

Signal Tracer Specifications:

*Uses the new Sylvania 1N34 Germanium crystal Diode which combined with a resistance-capacity network provides a frequency range of 300 cycles to 50 Megacycles. The Model 88 comes complete with all test leads and operating instructions. ONLY.....

\$2885 NET

20% DEPOSIT REQUIRED ON ALL C.O.D. ORDERS

MONEY-BACK GUARANTEE—We believe units offered for sale by mail order should be sold only on a "Money-Back-If-Not-Satisfied" basis. We carefully check on the design, calibration and value of all items advertised by us and unhesitatingly offer all merchandise subject to a return for credit or refund. You, the customer, are the sole judge as to value of the item or items you have purchased.

GENERAL ELECTRONIC DISTRIBUTING CO.

DEPT. RN-7, 98 PARK PLACE,
NEW YORK 7, N. Y.

"HOT" off the GRIDDLE!



2 BRAND NEW ADDITIONS TO THE HALLICRAFTERS LINE

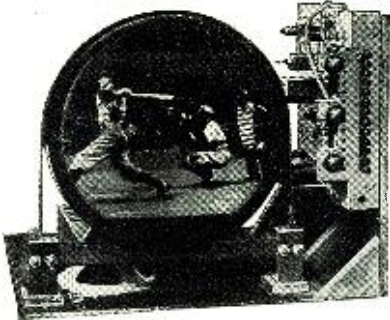

Model T-69
15" TV CUSTOM CHASSIS
 Now! Big picture television at a price. 130 sq. in. direct view picture. All 12 channel push button tuning. 8" PM speaker. Mounted on reinforced wood frame ready to be slipped into cabinet or opening in wall, etc. Dimensions 19½" high x 23" wide x 21¼" deep. Shpg. wt. 80 lbs. Complete with 15AP4 Picture Tube.....

\$259.50

NOW! NEW LOW PRICES ON
 T-64 Chassis Complete With 10" Picture Tube... **\$179.50**
 T-64 Chassis Complete With 12" Picture Tube... **\$199.50**



Model S-72

ALL WAVE PORTABLE

Standard broadcast and 2 short wave bands, 540 KC to 30.5 MC. AC, DC or Batteries. Built-in loop and whip antennas. Automatic noise limiter and BFO. Electrical band spread for the discriminating listener or the Radio Amateur. Shpg. wt. 16 lbs. Less batteries.....

\$79.95

Send for FREE Hallicrafters catalog
 Time Payments Available

Walter Ashe
RADIO CO.
 1125 PINE ST. ST. LOUIS 1, MO.
 PHONE CHEstnut 1125

DO YOU KNOW?

By DAVID SCOTT

72. What is the result in the reproduced picture if the vertical scanning is faulty?

A. If the vertical sync is not accurate, the lines in one field will not interlace correctly with the preceding field.

73. What is the result in the reproduced picture if the horizontal scanning sync is faulty?

A. If the horizontal sync is faulty, the picture elements in one line are displaced relative to those in other lines.

74. What is the free frequency?

A. The free frequency is the frequency determined by the circuit and tube constants.

75. What is sync frequency?

A. The sync frequency is the frequency of the sync pulses applied to the impulse generator.

76. Explain the interlocking action between the free frequency and sync frequency in sync action.

A. When the free frequency is approximately the same as the sync frequency, the impulse generator can be made to fall in step with the sync frequency. If the free frequency is lower than the sync frequency, the period between the grid pulses is shortened by the sync action. The tendency of the oscillator is to lag behind the sync pulses, but the sync pulses keep speeding it up. This is the desirable action, because the sync pulses then always occur at the end of a scanning motion. Therefore, the free frequency should always be set below the sync frequency by an amount large enough to insure that they do not become equal, but not so large that the sync circuit loses control. The sync must be the control mechanism, not the operator.

77. How many methods are there for separating the sync pulse from a signal?

A. The two methods for separating a sync pulse from a signal are: 1. Amplitude separation; 2. Waveform separation.

78. Explain amplitude separation.

A. In amplitude separation, the vertical sync signals have an amplitude greater than the horizontal sync signals by about 20 per cent. By applying the composite sync signal to a biased diode tube, only the high-amplitude vertical pulses get through, and by also applying the signal to a current limiting tube (pentode), only the low amplitude horizontal sync pulses get through.

79. Explain waveform separation.

A. In waveform separation, both horizontal and vertical sync impulses have the same amplitude. Hence, differentiation and integration circuits are designed so that the former respond to the shorter time constants of the horizontal sync pulses, and the latter respond to the longer time constants of the vertical sync impulses.

80. What is meant by a serrated type of vertical sync impulse?

A. The vertical sync impulse with horizontal impulses interspersed in it is known as a serrated type of vertical sync impulse. The vertical sync impulse is prolonged through three or four horizontal pulses but is broken up into smaller intervals so as not to obliterate the horizontal pulses.

81. Draw a simple schematic diagram illustrating differentiation and integration circuits.

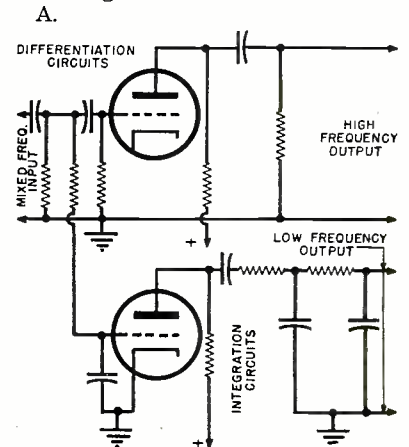

82. What is the purpose of equalizing pulses in a serrated type of signal?

A. The purpose of the equalizing pulses is to make the shape of every vertical impulse the same after separation. Otherwise, the timing between the sync impulses in successive fields would not interlock properly.

83. Why do equalizing pulses have no effect on the horizontal sync?

A. The equalizing pulses have no effect on the horizontal sync since they occur midway between the horizontal impulses, i.e., when the impulse generator cannot react to a sync impulse.

84. What is the ratio of scanning time to inactive blanking time?

A. The ratio of line scanning time to inactive blanking time is for all practical purposes 6:1.

(To be continued)

400-Watt Transmitter

(Continued from page 54)

operation in order that these tubes will act as a heavy bleeder on the power supply and improve regulation. The idling current of the pair of 811's runs about 50 ma. If for any reason the modulator tubes fail to operate, resistors R_2 , R_3 , and R_4 , in Fig. 4, will discharge the filter condensers in about 20 seconds. On the power supply deck are two other relays for the purpose of changing from transmit to receive. RL_2 is a heavy-duty s.p.s.t. relay for energizing the plate transformers when S_2 or the remote switch is operated. RL_1 was included to start the v.f.o. and to silence the receiver, and operates simultaneously with RL_2 . It may seem strange that RL_1 has its coil energized when receiving, instead of when transmitting. This was done so that when the transmitter is completely turned off by means of power switch S_1 , RL_1 will open the contacts to the receiver, and the send-receive switch on the receiver can then function normally.

The modulator driver employs a single 6L6GA, tetrode connected. There is no reason for using the customary triodes to drive zero bias modulator tubes, and in this case the single tube delivers sufficient audio power. The loading provided by the 811 grid circuit on the 6L6GA is almost constant, and very little distortion is introduced at this point. With the driver transformer ratio indicated, 100 per-cent modulation is reached just as clipping starts in the driver stage, and this allows a somewhat higher average modulation level to be used without side-band splatter. Because of the limited space available, and because of the proximity of the speech amplifier to the r.f. section, a single-button carbon microphone was used in preference to a low-level microphone with associated high gain stages. A *Western Electric* type F-1 button operated at low current gives excellent speech quality, and in many cases cannot be distinguished from high priced crystal or dynamic units for speech use. The microphone current in this case is obtained from the 350 volt power supply through R_1 (Fig. 5), and runs about 18 ma. R_1 also serves as a bleeder for this supply.

The r.f. section is built on a standard 13"x17"x3" chassis. The 813 sockets are mounted about 2" below the surface on two small aluminum angles running crosswise between sides of the chassis. The depth of the sockets should be adjusted until the internal shields of the 813's are flush with the surface. Referring to Fig. 3 (right), the 813 filament transformer may be seen at the lower-left side of the picture, and immediately before it is a small exhaust fan. The greatest heat dissipation in the transmitter is from this deck, due mainly to the 100 watt

IT'S A HIT

WALTER ASHE OFFERS



on your Used
Test and Communication
Equipment toward the purchase of...

hallicrafters TELEVISION

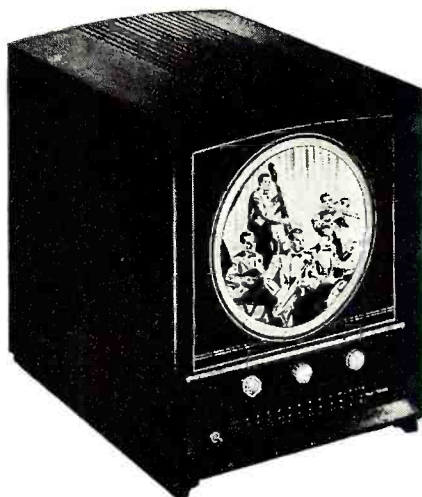

HALLICRAFTERS TV
Model 509

The latest addition to the Hallicrafters TV line. Push button tuning on all 12 channels. Dual Focus for larger round pictures with 56 sq. in. rectangular picture or 64 sq. in. full circle picture for dramatic close ups—all at a flick of a front panel switch. Mahogany veneer cabinet. Transparent safety shield. 19 tubes plus 3 rectifiers.

\$269⁵⁰

Complete with ALL TUBES. Shpg. Wt. 105 lbs.



HALLICRAFTERS TV
Model T-506

Here's Television at a price, with all the big set features. 12 channel push button tuning. Static free FM sound reception and 23 sq. in. screen. 18 tubes plus 4 rectifiers. Shpg. Wt. 50 lbs.

Now ONLY
\$149⁵⁰

Formerly sold for \$199.50

LATE NEWS FLASH!

2 sensational new additions to the HALLICRAFTERS line are now available . . . just in time for inclusion in our special advertisement on page 76 in this issue.

It's big news. Don't miss it!

Phone: CHestnut 1125

ALL PRICES F. O. B. ST. LOUIS

TIME PAYMENTS AVAILABLE

FREE

Big, new 1949 Catalog of Radio, Electronics and Television. Order your copy today!

Walter Ashe Radio Co. R-49-7 a
Bill DuBord, WØQDF, Mgr., TV and Amateur Div.,
1125 Pine St., St. Louis 1, Missouri

Rush bigger-than-ever "Surprise" trade-in allowance on my _____ for Hallicrafters TV
(describe used equipment)

(show model of new equipment desired)

Mail me my copy of latest Hallicrafters Catalog.

NAME _____

ADDRESS _____

CITY _____

ZONE _____

STATE _____

Walter Ashe
RADIO CO.

THE HOUSE OF "SURPRISE" TRADE-INS
1125 PINE ST. • ST. LOUIS 1, MO.

It opened
 10,000 pairs
 of expert eyes
 at Chicago's
 electronics
 show!

Watch for the
 announcement
 of a truly
 sensational new,
 ultra-sensitive
 Television
 Receiver
 by

The RADIO CRAFTSMEN

write for information

Inc.

1341 S. Michigan Ave., Chicago 5, Ill.

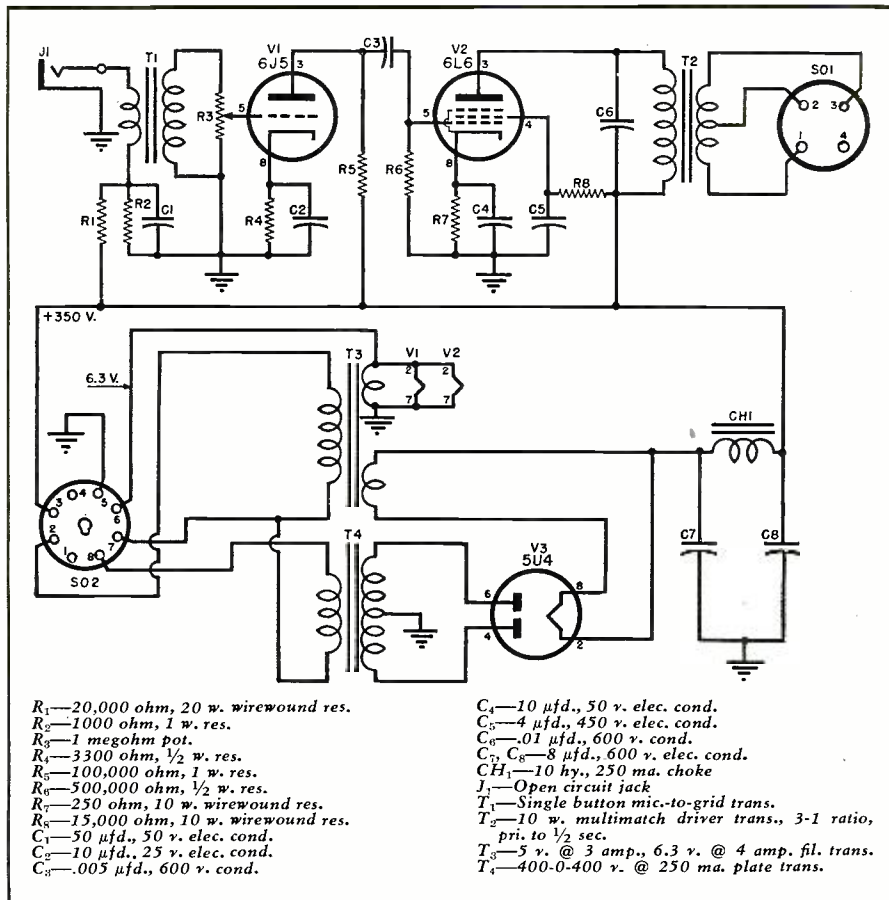
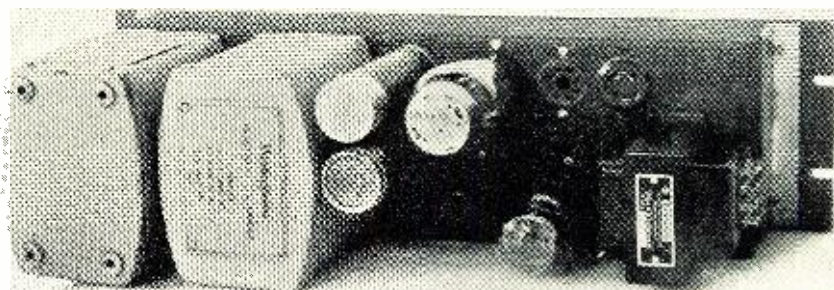

Fig. 5. Schematic diagram of low-voltage power supply and speech amplifier.

loss in the filaments and another 150 watts or so plate dissipation. The rig was operated several months without the fan, and no ill effects resulted, but at times the heating of the rear sides of the meters caused such moisture condensation on the meter faces as to prevent seeing them. The fan is powered by a shaded pole phono motor with the coil rewound for 5 volt operation, using 90 turns of #16 en. wire. A small opening was cut in the cabinet just opposite the fan and was covered with hardware cloth. In front of the fan may be seen the three 6L6 multiplier stages. It is essential that these be metal tubes in order to prevent oscillation of the 813's. Between the 6L6's, the unshielded slug-tuned coils are mounted directly on the chassis with the adjusting screws protruding

through. Beneath the chassis, the grid tuning condenser is centered between the 813's, and a shaft extension goes to the front panel. The antenna relay may be seen at the rear of the final tank coil. To reduce the tank coil height sufficiently, a special jack strip was made of a piece of polystyrene, 1½" wide, and was bolted directly to the chassis. When the transmitter was first built, small feed-through insulators were placed beside the 813's, and wires were run alongside the tubes for neutralization. Contrary to expectations, the neutralization improved as more of the wire was clipped off, and perfect neutralization could not be obtained until all of the neutralizing circuit was removed. The fact that no neutralization is required is attributed to the short direct by-

Fig. 6. Top view of the speech amplifier and low-voltage power supply.



PERMALLOY SHIELDS
for CATHODE RAY TUBES

3" Shield.....\$1.47
5" Shield.....1.97



NOW AVAILABLE

1000 KC Crystal.....\$2.97
Socket......07

SELENIUM RECTIFIERS
Full Wave Bridge Type

INPUT		OUTPUT			
up to 18v AC	up to 12v DC	1/2 Amp.	\$1.47	1B24	\$4.87
up to 18v AC	up to 12v DC	1 Amp.	1.97	1B26	3.97
up to 18v AC	up to 12v DC	5 Amp.	5.27	1B29	3.47
up to 18v AC	up to 12v DC	10 Amp.	8.97	1B32	1.97
up to 18v AC	up to 12v DC	15 Amp.	11.57	2C21	.67
up to 18v AC	up to 12v DC	30 Amp.	22.57	1N23	.67
up to 36v AC	up to 28v DC	1 Amp.	3.47	1N34	1.37
up to 36v AC	up to 28v DC	5 Amp.	8.57	1P24	2.87
up to 36v AC	up to 28v DC	10 Amp.	14.57	2AP1	3.87
up to 36v AC	up to 28v DC	15 Amp.	22.27	2C21	.27
up to 115v AC	up to 100v DC	25 Amp.	2.57	2C22	1.17
up to 115v AC	up to 100v DC	6 Amp.	5.27	2C26A	.27
up to 115v AC	up to 100v DC	5 Amp.	22.57	2C34	.27
up to 115v AC	up to 100v DC	3 Amp.	17.97	2C40	6.57
				2C44	.97
				2C46	6.87
				2D21	1.27
				2J21	11.47
				2J22	13.97
				2J26	12.47
				2J48	19.97
				2J54B	3.97
				2K25	32.97
				2K28	32.97
				2V30	.97
				2X2	.37
				3AP1	3.97
				3B32	2.97
				3B34	1.87
				3B26	1.47
				3BP1	1.37
				3CP1	2.67
				3CP2	3.97
				3C23	.37
				3C24/24G	.57
				3C30	.37
				3C31	1.47
				3D21A	1.47
				3D11	1.97
				3E29	8.97
				3GP1	4.97
				4AP10	2.97
				4B24	2.27
				5A27	12.97
				5A28	3.97
				5BP1	1.87
				5BP4	2.97
				5CP1	1.97
				5CP1A	8.97
				5D21	34.97
				5FP7	.37
				5JP2	39.97
				5LP1	13.97
				5NP1	8.97
				5R4GY	1.17
				6C21	24.97
				6J4	5.87
				9GP7	9.97
				9JP1	3.57
				9LP7	3.57
				10Y	.37
				12DDP7	12.37
				12GPT7	12.97
				15E	1.97
				15R	.97
				28D7	.37
				30A26	.47
				45Spea	.37
				75TL	2.87
				100R	1.47
				100TH	9.97
				21A	.47
				227A	2.97
				249C	2.57
				250R	9.97
				250TH	19.47
				250TL	19.47
				294A	4.97
				304TH	3.47
				304TL	1.47
				305A	12.47
				307A	3.97
				316A	.67
				327A	2.97
				350B	1.47
				368AS	3.27
				371B	.97
				378A	1.97
				434A	3.27
				446A	3.47
				450TH	18.47
				451	1.47
				530	22.57
				531	4.97
				532	2.87
				559	5.97
				575A	12.97
				703A	3.27
				705A	1.97
				706CY	18.97
				707B	8.47
				708A	1.97
				713A	1.27
				715C	7.57
				715C	34.97
				717A	2.97
				721A	2.97
				723AB	12.97
				725A	12.87
				726A	7.57
				760TL	44.97
				800	1.87
				801A	.27
				802	\$2.97
				803	4.87
				804	6.57
				805	3.87
				807	1.07
				808	1.57
				809	2.47
				810	5.97
				811	1.97
				812	2.47
				813	6.47
				814	2.67
				815	1.87
				816	1.07
				826	.47
				829B	5.97
				830B	3.57
				832A	4.57
				833A	32.57
				836A	.97
				837	1.27
				838	2.87
				841	.37
				843	.37
				845	4.17
				851	24.97
				860	1.87
				862A	10.47
				862A	49.77
				864	.47
				865	.47
				866A	1.17
				866JR	1.17
				869	27.57
				872A	1.67
				874	.57
				876	.67
				878	1.27
				884	1.27
				888	1.27
				891	2.67
				902P1	4.97
				905	1.87
				923	.27
				954	.87
				955	3.97
				958	.37
				957	.27
				958A	.27
				1613	.57
				1616	.87
				1619	.27
				1624	.27
				1625	.37
				1626	.37
				1629	.27
				1630	1.87
				1633	3.97
				1638	1.47
				1641	.57
				1654	1.97
				1851	.97
				1920	2.97
				2050	.67
				2051	.47
				8011	1.27
				8012A	1.47
				8013A	1.27
				8014	3.37
				8020	1.47
				8025	3.57
				9001	.37
				9002	.37
				9003	1.27
				9004	.37
				9006	.27
				C6J	3.97
				CK507AX1	.47
				CK1005	.27
				CK1090	1.27
				E1148	.67
				EF50	.47
				F123A	14.97
				F127A	17.97
				F128A	39.47
				F660	49.47
				F882A	49.47
				FG17	2.87
				FG81A	3.97
				FG95	8.97
				FG105	9.97
				GL697	29.47
				HY69	3.97
				HY615	.37
				ML100	19.97
				ML101	49.47
				ML502	69.47
				RK59	1.97
				RK60	.57
				RK72	.67
				RK73	.97
				RK75	3.97
				RK705	1.97
				RX21	3.27
				RX120	9.97
				SS36	2.97
				VR75	.97
				VR78	.37
				VR90	.67
				VR105	.67
				VR150	.57
				VT127A	2.87
				VTU111	.37
				024	\$0.67
				1A5GT	.47
				1A7GT	.67
				1H5GT	.57
				1L4	.67
				1LC6	.87
				1LD5	.77
				1LE3	.97
				1LL4	.77
				1LN5	.67
				1NSGT	.57
				1P4	.67
				1R5	.57
				1T4	.57
				2A3	.97
				3A5	1.37
				5U4G	.87
				5V4	.87
				5W4	.67
				5X4	.57
				5Y3	.37
				5Y4	.47
				5Z3	.47
				6A5	.77
				6A7	.67
				6A8GT	.67
	</				

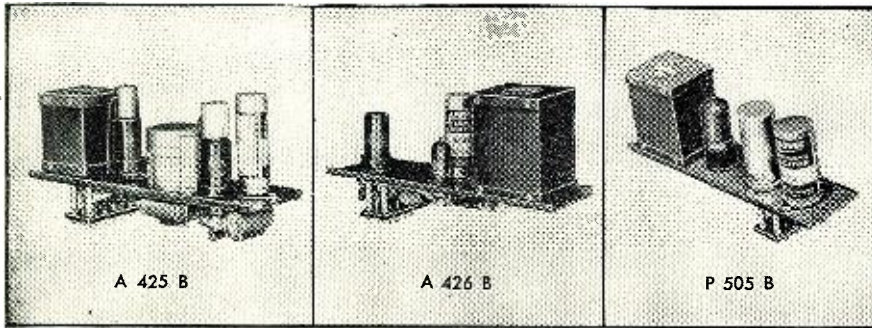

ANNOUNCING A NEW LINE OF PRE-AMPLIFIERS TO MEET THE NEED FOR GREATER FLEXIBILITY IN PUBLIC ADDRESS & RADIO BROADCAST SYSTEMS

The new Altec Lansing line of input amplifiers meets a demand for units of small size with excellent characteristics. Dimensions of the A-425B Pre-Amplifier with mixer control, the A-426B Line Amplifier and the P-505B Power Supply are 2½ inches wide by 10 inches long.

The 10675 Mounting Base permits mounting 6 units of any type in a standard rack or in a mixer console. Thus, complete facilities for 4 microphone inputs with line amplifier and power supply

will occupy the space 19 inches wide by 10½ inches high.

All amplifiers have a flat frequency response from 20 to 20,000 cycles.

☆☆☆☆☆☆

Full technical description upon request.

1161 North Vine St.
Hollywood 38, Calif.

161 Sixth Avenue
New York 13, N.Y.



IN THE PROFESSION, AN HONORED NAME

TUBES - TUBES

TERRIFIC VALUES! Stock up now at up to 80% off list! Perfect condition. GUARANTEED 90 DAYS! Unsealed cartons.

39¢	27	80	6A4	6X5
	35/51	85	6A7	12SK7
	39/44	89	6H6	35Z5
ca.	77	5Y3	6K7	25L6

01A	5T4	6G5	7A8	49¢
10	5U4	6J5	7B6	
24	5Y4	6I7	7B6	
41	5Z4	6K6	7B7	
42	6A3	6SA7	7C5	
46	6A8	6SD7	7C6	
50	6AC7	6SF5	7C7	
78	6B7	6SG7	7G7	
84	6C5	6SJ7	7H7	
1A7	6D6	6SH7	7V7	
1L6	6E5	6SK7	7Y4	
1L4	6F5	7L6	12SA7	
3H5	6F6	7A7	12SJ7	

TUBE CARTONS

MINIATURE (1" x 1½" x 2½")	Per 100	\$0.98
GT SIZE (1½" x 1½" x 3¼")	Per 100	1.25
MEDIUM (1½" x 1½" x 4¼")	Per 100	1.49
LARGE (2" x 2" x 5")	Per 100	1.79

!SPECIAL!—LINE NOISE FILTER—Precision engineered, heavy duty, capacitive-inductive type. PREVENTS INTERFERENCE FEEDBACK INTO LINE—REMOVES INTERFERENCE FROM MOTORS, LAMPS, ETC.

—Bakelite case (5" x 2½" x 3½") with receptacle, cord & plug. Rated: 110V. AC-DC, 5 amps. Ship. wt. 2 lbs. ONLY. **\$2.95**

RADIO HARDWARE TREASURE—A FULL POUND of Screws, Nuts, Washers, etc. ALL IN A HANDY SELF-SEALING HINGED LID METAL CAN. Ship. wt. 2 lbs. **49¢**

4 TUBE AMPLIFIER FOUNDATION—Ideal for building any small electronic unit. Black crackle cabinet & slide-in chassis contain: power trans., mica & oil condensers, resistors, sockets, etc. 8¼" x 4½" x 3¾". WEIGHS ONLY 4 lbs. A STEAL AT. **95¢**

HEARING AID AMPLIFIER ASSEMBLY—Sonotone vacuum tube type. MAKE A REAL VEST POCKET RADIO, adding only tuner sect. & speaker or phone. Ready-wired miniature components include: 2 controls, output trans. dbie. choke, switch, resistors, condensers, etc. COMPLETE WITH SCHEMATICS FOR BUILDING A 2 or 3 TUBE SET! Overall: 1½" x 2" x 5". WEIGHS ONLY 3½ ozs. **\$2.49**

SUB-MINIATURE TUBES FOR AMPLIFIER. Set of 2. **\$2.49**

Min. order \$2.00—20% Deposit Req. on all C.O.D.'s. Please add sufficient postage—excess refunded.

EOTONE RADIO CO.
68 Day Street
New York 7, N. Y.

SURPLUS TRANSFORMER SPECIALS

CASED PLATE TRANSFORMER
Pri. 110-230 V. 50/60 cycles; Sec. 1050 V. C.T. @ 75 Ma.; 740 V. C.T. @ 175 Ma.; Housed in hermetically sealed case. Price... **\$2.95**

CASED FILAMENT TRANSFORMER
Pri. 110-230 V. 50/60 cycles; Sec. 5 V.—3A; 5V.—3A; 6.3 V.—5A; 6.3V.—2.4 A. Housed in hermetically sealed case. Price... **\$2.45**

FILAMENT TRANSFORMER
Same windings as above, but open frame type. Price... **\$1.45**

MINIATURE FILAMENT TRANSFORMER
Pri. 115 V. 60 cycles; Sec. 4 V. ½ A.; Overall dimensions 1½" x 2" x 1½". Housed in hermetically sealed case. Price... **\$0.35**

FILTER CHOKE
30 henry, 200 ohms, 75 Ma.; Open frame type. Price... **\$0.45**

500 WATT CLASS B MODULATION TRANSFORMER
Maximum output level 50 Db.; Primary Impedance 6600 ohms, ½ ampere; Secondary Impedance 1150-2300-1150 ohms, 3 ampere. Housed in hermetically sealed case with glass standoff insulators. Price... **\$16.50**

HIGH IMPEDANCE CHOKE
200 Henry, resistance 5000 ohms. Housed in small hermetically sealed case with solder-ceramic terminals. Price... **\$0.45**

UNIVERSAL OUTPUT TRANSFORMER
Match any single or push-pull tubes to any voice coil—10 watts audio. Price... **\$0.65**

AC-DC Filter Chokes—12 Henry 40MA. Price... \$0.40

FILTER CHOKE
8 Henry 160 MA. Price... **\$1.35**

MODULATION TRANSFORMER
Primary Impedance 8000 ohms, 135 Ma.; Secondary Impedance 5000 ohms, 50 Ma.; 2500 V. Insulation. Housed in hermetically sealed case. Price... **\$2.85**

RADIOSONDE (Weather) Transmitter AN/AMQ-1D
Includes following: 1—Miniature Battery Transmitter complete with 3A5 tube—operates on 72 mc approx.; 1—Miniature sensitive relay SPDT with 100 ohm coil; 1—Temperature-sensitive resistance element; 1—Humidity sensitive strip; 1—Pressure, temperature, humidity chart, the entire unit is encased in the original packing and is brand new. New Reduced Price... **\$3.95**

Write for Latest Catalog R7 Listing Thousands of Relays, Resistors, Condensers, Switches, etc.

EDLIE ELECTRONICS, INC.
Telephone Digby 9-3143
154 Greenwich Street New York 6, N. Y.

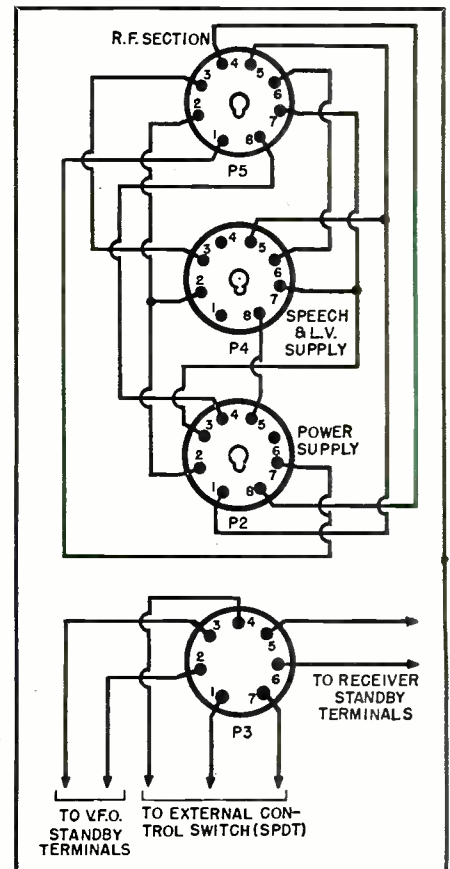

Fig. 7. Diagram shows interconnection between various units. Plug P5 connects to SO₁ in Fig. 2, P4 to SO₂ in Fig. 5, P2 to SO₃ in Fig. 4, and P3 to SO₃ in Fig. 4.

pass on the 813 screens, and to the use of a sufficient amount of shielding. The keying relay, and bias supply with VR tube are mounted below the chassis.

"Dish type" construction is used for the 350-volt power supply and speech amplifier, and this chassis measures 5" x 17" x 2½". This type of construction was used to provide shielding of the speech amplifier circuits from the plate caps of the 811's.

A special 1" high chassis had to be constructed for the 1250 volt power supply and modulator in order to provide sufficient clearance for the power transformer. The local machine shop welded some 1" x 1" steel angle into a 12" x 17" rectangle. On this rectangle was bolted a 12" x 17" piece of sheet metal. The chassis was joined to the front panel by means of a pair of 12" deep chassis supporting brackets. The control relays are mounted inside a small aluminum chassis, used as a box, on the rear of the power supply deck (see Fig. 3, left). On this box are sockets to connect to the external control cable, to the transmitter cable, and to the interlock switch. This interlock switch is located at the hinged top of the cabinet to remove high voltage when coils are changed. The 866 tubes are at the center of the power supply deck, and to the right, in Fig. 3 (left), may be seen the 811's. Hidden in front of the 811's is the modulation transformer, and above this transformer is the phone-c.w. relay.

Instead of lacing the interconnecting cables with twine, some of the plastic spiral that is sold to prevent telephone cords from kinking was wrapped about the wires, and gave a neat, professional-looking appearance. Special nameplates for the meter switch and band selector were made by lettering on white drawing paper.

Initial tuning should be done with the bandswitch on the 10-meter position, 10-meter coils in place, and a crystal of about 7100 kc. inserted. Plate and screen voltages on the 813's should be removed during the initial tune-up. With the shield removed temporarily from L_3 , C_{12} (Fig. 2) is adjusted with the aid of a wavemeter to 28 mc. resonance, and the shield is replaced. L_1 and L_2 are broad enough to pass some r.f., even though not peaked. Now, L_1 and L_2 are tuned for maximum 813 grid current. Since these coils are tuned largely by circuit capacity, and since this will vary with different layouts, the turns may have to be altered somewhat to get a definite peak. A load is now connected to the transmitter, voltages are applied to the 813's, and C_{13} (Fig. 2) is resonated. Comparison of the 813 screen currents is used to determine if equal excitation is applied to the tubes. If these currents are not the same, trimmer C_{13} should be adjusted to restore balance. The adjustments of L_1 , L_2 , and C_{13} once made for the 10-meter band will hold sufficiently close for other bands.

Now when changing bands, it is necessary to replace only the 813 grid and plate coils, set the band switch properly, plug in the v.f.o. or proper crystal, and retune. There is no need to worry about running the final off resonance for short periods, since the dissipation is not excessive at the low plate voltage used. Although an 80-meter crystal or v.f.o. output may be used for operation on any band, it is recommended that for 10-meter operation a higher frequency crystal or v.f.o. be used. The broad-band circuits will pass sufficient energy to allow L_3 to be tuned to approximately 25 or 32 mc., and yet the dial settings may appear to be correct. For normal operation the total grid current should be 15 or 20 ma., and with proper plate load, the screen current to each 813 is 20 to 25 ma. For phone operation the plate current should be about 300 ma., and for c.w. operation it may be as much as 400 ma. Keep in mind that the 500 ma. meter on the 813's is in the cathode circuit, and grid and screen currents must be subtracted to get plate current.

This rig has been thoroughly tested on all bands, and leaves nothing to be desired in the way of performance. Consistent weekly schedules have been held for some time now on 75-meter phone, over a 500-mile path and through the evening QRM. On the few occasions that DX operation has been tried on 10 meters, a number of countries were worked, including a VK at high noon.

-50-

July, 1949

You Build 'em
in
ONE EVENING
but...

THEY LAST A LIFETIME!

EICO

INSTRUMENT
KITS

HIGH-PRECISION
VACUUM TUBE
VOLTMETER

Model 221-K

\$23.95



Tops in work bench versatility. 15 different ranges! AC and DC ranges: 0/5/10/100/500/1000 volts. Electronic ohmmeter ranges from 2 ohms to 1000 megohms in 5 steps. New features include Zero Center for TV discriminator alignment. DC input impedance is 28 megohms. Exceptionally accurate, big 4 1/2" meter cannot burn out. Double triode balanced bridge circuit assures stable, guaranteed performance. Sturdy portable steel case with etched, rubproof panel. 110-130 V. AC 50-60 cycle. Size 9 1/8" x 6" x 5".

FACTORY-WIRED VTVM

Model 221. Same, but completely wired, calibrated, and tested \$49.95

Pocket VOLT-OHM
MILLIAMMETER



Model 511-K. A "must" for servicemen! Perfect kit for the beginner. 5 AC ranges to 1000 V; 5 DC ranges to 2500 V; Ohms, to 1 meg.

3" precision meter. New improved Germanium crystal circuit \$14.95
Model 511 Factory-wired, tested.. \$17.95

NEW! MODEL 320-K
SIGNAL GENERATOR

\$19.95



An excellent instrument for service, lab, and school use. Can be used for FM-AM alignment and to provide TV marker frequencies. Highly Stable Hartley oscillator has range of 150 kc to 100 mc with fundamentals to 34 mc. Colpitts audio oscillator supplies pure 400 cycle sine wave voltage for modulation. Audio oscillator voltage can be used for testing distortion in audio equipment, bridge measurements, etc. Handsome etched panel with easy-to-read calibrations. Easily assembled and aligned. Complete with tubes. FACTORY WIRED AND ALIGNED
Model 320. Ready to use..... \$29.95

FREE! Write today for colorful new catalogue, and name of your nearest jobber. NOTE: Prices do not include shipping charges.

5" 'SCOPE

Model 400-K

\$39.95



Quality throughout! Laboratory precision scope, for FM, AM, & TV servicing. Deflection sensitivity: .65 volts per inch full gain. Linear sweep with 884 gas triode. Horizontal sweep circuit, 15 to 30,000 cycles. Frequency response of horizontal and vertical amps is from 50 to 50,000 cycles. Provision for external modulation, test voltage, and intensity 884, and 5BP1 CR tube. Graph screen for measuring peak to peak voltages. Operates on 110 front of handsome 3-color etched, rub-proof 40 lbs. Size: 8 1/4" x 17" x 13" high. Shpg. wt. Pictorial and Schematic diagrams are included. FACTORY-BUILT OSCILLOSCOPE
Model 400. The same high-quality, life-long instrument, but fully wired, assembled, and tested. \$69.95

PENCIL-TYPE
HIGH FREQUENCY RF PROBE KITS

Germanium crystal probes for visual RF signal tracing and measurements to over 200 megacycles. 1/2" O.D., 6 1/2" long. Model P-75K. Can be used with EICO Models 221, 113A, or any VTVM!
Model P-76K. For Models 400 & 145 \$3.75
Models P75 or P76. Same as above but factory wired and tested. Each... \$7.50



NEW!
MULTI-SIGNAL
TRACER

Model 145-K. Versatile, high gain, high frequency instrument. Self-contained test speaker permits audible signal tracing of RF, IF, FM, audio, and video circuits. Has provision for visual tracing with VTVM. Response is well over 200 mc. 3-color hamertone panel. 110-125 V. AC. Size 10" x 8" x 4 1/4". Comes complete with tubes and diode probe in kit form \$18.95
FACTORY-BUILT AND TESTED
Model 145. Ready to operate..... \$28.95

EASY-TO-FOLLOW SCHEMATIC
& PICTORIAL DIAGRAMS

come complete with every EICO instrument Kit.

Each kit fully guaranteed to operate perfectly when assembled according to our instructions!



JOBBERS: Write today for complete literature and discounts.

ELECTRONIC INSTRUMENT CO., INC.
276 Newport Street, Brooklyn 12, N. Y.

Dry-Disc Rectifiers As Control Circuit Components

By **RONALD L. IVES**
Dept. of Geography, Indiana University

The use of dry-disc rectifiers in a number of formerly troublesome control circuits will reduce the installation and maintenance costs considerably.

ALTHOUGH the dry-disc rectifier has been commercially available for more than two decades, its use has been restricted by most workers to rather obvious battery-charging and power supply installations.

Because rectifiers of this general type are relatively inexpensive, have no moving parts or chemical solutions, require no heating current, are substantially immune to all temperature variations found in nature, and have a gratifyingly long-service life, their inherent properties suit them for remote control applications.

By use of dry-disc rectifiers, a number of formerly-troublesome remote control problems can be solved, in some instances with a halving of installation and maintenance costs, and a quartering of "in service" breakdowns. Several of these applications are outlined in Fig. 1. Many others, obvious applications of the same general principles, are known, or can be worked out in a few minutes by the instrument technician.

Operation of a remote latching relay, by use of a two-wire line and two rectifiers, is shown in Fig. 1A. Here, when the proper voltage is applied to the line with one polarity, the lock-in

coil is energized. When current is applied to the line with the polarity reversed, the release coil operates. This application eliminates a somewhat costly, and usually troublesome, polarized relay.

Similarly, several independent devices can be operated from the same line by use of rectifiers, as in Fig. 1B. Here, the 1st load is energized when the line voltage is of one polarity, 2nd is energized when the line has the other polarity, and 3rd operates whenever the line is energized, regardless of polarity. If a.c. is applied to the line, loads 1 and 2 will both draw current, and device 3 either will or will not operate, depending upon its response to a.c. If a.c. is used for a third control combination, use of condensers or other smoothing devices may be necessary to prevent "buzzing."

By use of a bridge rectifier, the age-old problem of controlling the direction of rotation of a series-wound d.c. motor by the polarity of the two-wire supply line is solved and without the use of polarized relays. One of several alternative methods of doing this is shown in Fig. 1C. Here, the field is connected in series with the input of a bridge (full-wave) rectifier, and the armature is connected across the out-

Fig. 1. Typical applications of dry-disc rectifiers as used in control circuits. A d.c. power line should be used in all four of the circuits shown.

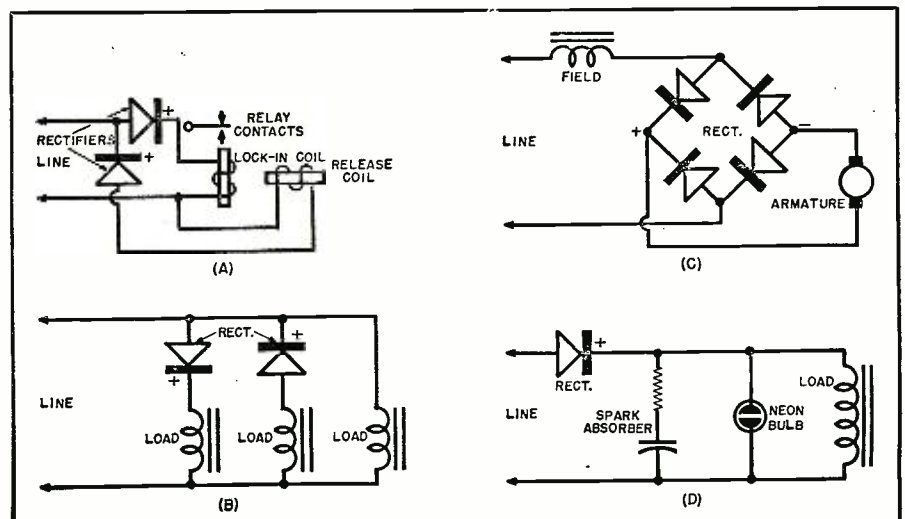

STANDARD AND HEAVY DUTY INVERTERS



For Inverting D. C. to A. C.

Specially Designed for operating A. C. Radios, Television Sets, Amplifiers, Address Systems, and Radio Test Equipment from D. C. Voltages in Vehicles, Ships, Trains, Planes and in D. C. Districts.



AUTO RADIO VIBRATORS

A Complete Line of Vibrators . . .
Designed for Use in Standard Vibrator-Operated Auto Radio Receivers. Built with Precision Construction, featuring Ceramic Stack Spacers for Longer Lasting Life.

NEW MODELS NEW DESIGNS
NEW LITERATURE
"A" Battery Eliminator, DC AC Inverters, Auto Radio Vibrators
See your jobber or write factory

AMERICAN TELEVISION & RADIO CO.
Quality Products Since 1931
SAINT PAUL 1, MINNESOTA-U. S. A.

YOU'LL SAVE MANY DOLLARS WITH THIS FREE CATALOG AVAILABLE TODAY

WRITE or PHONE DI 9-4124
Att. Mr. Chas. Rosen
★ ★ SPECIALS ★ ★
Mobile Minded? Citizens' Band Antenna
 Threaded Coax Terminal HiFreq Insul Sivi PI Cont 12"/30cm AT/5/ARRI w/waterpt gask, flange & ALL hardware for MOBILE mtg. BRAND NEW!
49¢ 3 for \$1; PL 250 for above.....35c

COMMUNICATIONS EQUIPMENT COMPANY
for your needs

BC AR 223 TUNING UNITS
 C—Range 545-850 Kc
 D—Range 850-1330 Kc
 E—Range 1330-2040 Kc
 F—Range 2.04-3 Mc
 G—Range 3-4.5 Mc
 H—Range 4.5-6 Mc
 K—Range 9.05-13.5 Mc
 L—Range 4-6 Mc
 M—Range 5200-7700 Kc
 N—Range 6000-9050 Kc

\$1.25
 each

BC AR 230 OR 430 T UNITS
 #382 3.2-4 Mc }
 #484 5-6.2 Mc }
 C184 4-5 Mc }
 (w/xtal) }

95¢ Ea.
\$1.95

RUBBER COVERED CABLE
 4 1/2 ft long w/red, blk & white Leads for 12c
 Mike or Hdset.....\$1.00

CABLE CLAMPS
 Tinn. #1, 4, 6, 7, Lock type. Price 8c ea. **75c**
 10 for.....

CABLE CLAMP ASSORTMENT KIT
 Contains a few Rubber Covered Locking type and many different types. 50 for. **\$1.00**

VARIABLE CONDEN.
 Wobler 2.75-8.85 mmf. 3 rotary plates. **75c**
 Price.....



932 PHOTO TUBE
 Gas Phototube having S1 response, particularly sensitive to Red and Near Infrared Radiation. Can be used with incandescent light source.
 Send for Data. **\$1.25**
 Price.....

1619-1619-1619
 Octal Base Pentog Aversa- **21c**
 Title High Perveance Tube. 3 for.....\$1.00

TRIMMER CONDENSERS
 2.8-27 mmf **35c Ea.**
 3.9-50 mmf
 3.2-42 mmf
 3.25 mmf 2:1
 3.5-47 mmf
 2.8-35 mmf 3 for **\$1.00**

BUZZER HIGH FREQ
 6V used in B19. **98c**
 Price.....

HiGain Dyn Mike Xfmr UTC/SuperElec 3wdg 600 CT&400ohms tapped 250 & 150 ohms. Fully Shielded Herm **59c**
 Sid. 2 for 98c; 10 for \$4.50

ROTARY BEAM COUPLER
 RF Coupler 360° rotation 1 turn coupling link. Plastic case mount on side. Price..... **\$2.95**

FLEXIBLE ANTENNA
 AN130 33" Whip w/Flexible Neck in 2 sections. Price..... **\$1.75**

WHIP ANTENNA
 MS49 & MS50 for Mobile or Dipole 74" **49c Set**

ELECTROLYTICS AND PAPER COND.
 2500Mfd 8VDC 3"x1" 3-\$1.00
 400Mfd 6V 2"x1" 5- .95
 50Mfd 12V 2"x1" 6- .85
 10Mfd 25V 2 1/4"x1" 10- 1.10
 10Mfd 25V 2 1/4"x1" 10- 1.10
 3x20Mfd 25V 2 1/4"x1 1/2" 4- .95
 25Mfd 25V 2 1/4"x1 1/2" 6- .85
 2000Mfd 25V 4 1/2"x2" @ 1.19
 30Mfd 50V 2"x3/4" 5 1.10
 2x25Mfd 50V 3 1/4"x1 3/4" 5- 1.10
 100Mfd 50V 1 1/2"x1" 4- .95
 .13Mfd 100V 1 1/2"x1" 10- .75
 .05Mfd 120V 7/8"x3/4" 10- .75
 .5Mfd 120V 2"x3/4" 10- .95
 .13Mfd 150V 2"x3/4" 10- .75
 .25Mfd 200V 1 1/2"x3/4" 10- .75
 1 1/2"x3/4" 10- .75
 Write for List of Others

TUBES! Outstanding Values

01-A .45	15P .140	804 .99.95
1B26 4.85	28D .75	815 2.50
2C22 69	30 (Spec.) .70	836 .70
2C22 69	45 (Spec.) .59	837 .95
2J21-A 25.00	39/44 .49	843 .59
2J22 25.00	35/51 .72	860 15.00
2J26 25.00	227A 3.85	861 40.00
2J27 25.00	225 8.80	874 1.95
2J31 25.00	288-A 20.00	874 4.95
2J32 25.00	355-A 19.50	1005 .35
2J38 35.00	417A 25.00	1619 .21
2J39 35.00	530 90.00	1624 .85
2J34 55.00	531 45.00	1629 .35
2J40 65.00	532 3.95	1961 5.00
2J49 65.00	559 4.00	9002 .65
3J31 55.00	562 90.00	9004 .47
2K41 65.00	615 .89	CEQ 72 1.95
2X2/879 .69	700 A,B,C,D \$50 ea.	EF 50 .79
3BP1 2.25	703-A 7.00	F-127 20.00
2C24 704-A 75	3C03 75	FC 258A 165.00
3D6 79	705-A 2.85	GL 532 7.50
3CP1 3.50	706 A,Y,B,Y. \$50 ea.	GL 562 75.00
3D21-A 1.50	DY 706 E,Y,F.Y. \$50 ea.	GL 623 75.00
3BP1 2.25	G 1707-B 29.00	GL 697 75.00
3F7 2.95	1714AY 25.00	ML 100 60.00
3F7 2.95	714AY 25.00	QK 60 65.00
3Q5 1.20	715-B 12.00	QK 61 65.00
5BP1 1.95	720BY 50.00	QK 62 65.00
5BP4 4.95	720CY 50.00	VR 91 1.00
3CP1 3.75	721-A 3.60	VR 130 1.25
5F7 39.50	725-A/B 12.50	VR 135 1.25
3J30 2.00	724B 1.75	VR 137 1.25
6G 725-A 25.00	725-A 15.00	VU 120 1.00
6SC7 1.00	726-A 15.00	VU 134 1.00
7E5 1.00	728 A,Y,B,Y. \$50 ea.	WL 532 4.75
7E6 .72	CY 729 D,Y,E,Y. \$50 ea.	WN 150 3.00
10Y .60	FY 729 D,Y,E,Y. \$50 ea.	WT 260 5.00
12A6 .35	FY,GY \$50 ea.	
12K8Y .65	730A 25.00	
12SF7 .49	800 2.25	
12SR7 .72	801-A 1.10	

MICROWAVE TEST EQUIPMENT
THERMISTOR BRIDGE: Power meter I-203-A. 10 cm. mfg. W.E. Complete with meter, interpolation chart, portable carrying case as shown. **\$72.50**
TS 12/AP VSWR METER: Consisting of Slotted Line, and all additional fittings and ampl. for 3CM operation. New and complete. **\$450.00**
 Bell Labs. Dual Mount mixer-beacon assemblies. 2 complete mixer-beacon mounts on gold-plated waveguide section **\$50.00**
 Slotted Line, Bell Labs. 1 1/2"x5/8" guide, gold plated. **\$150.00**
 W. E. I 138. Signal generator, 2700 to 2900 Mc range. Lighthouse tube oscillator with attenuator & output meter. 115 VAC input, reg. Pwr. supply. With circuit diagram **\$50.00**
 3 cm. Wavemeter: 9200 to 11,000 mc transmission type with square flanges. **\$15.00**
 3 cm. stabilizer cavity, transmission type. **\$20.00**
 3 cm. Wavemeter. Micrometer head mounted on X-Band guide. Freq. range approx. 7900 to 10,000 Mo. **\$75.00**

A Complete Line of Microwave Plumbing
 Send for List

RADIO-RADAR SETS

APS-15A	SO-13 (used)	QBG-1 (new)
SE (new)	SQ (used)	TBM (used)
SF (used)	CPN-6 (unused)	TDE (used)
SG (used)	APS-3 (used)	RAK-7 (new)
SN (used)	APS-4 (used & new)	TBK-19 (new)
SO-1 (used)	APS-15 (near comp)	SCR-545A (new)
SO-12	SO-3 (new)	BC-446J (new)

WRITE FOR DATA OF MANY OTHERS

TRANSFORMERS AND CHOKES
115V 60 Cy. Input Equip. Conserv. Rated

FILAMENT TRANSFORMERS

5V/6A \$2.25
 2.5VCT/6.5A, 5V/2A 3.25
 6.3VCT/2A, 6.3VCT/2A 1.85
 F5087; 6.3VCT/1A, 6.3VCT/7A 2.75
 2x6.3V/1A 1.95
 8V/1.5A 2.75
 F5123; 6.3VCT/5A, 6.3V/1A 2.25
 F5127; 6.3VCT/3.2A, 6.3VCT/1A 2.25
 F7: 2.5V/1.75A, 6.5V/8A, 5V/3A, 6.5/6A. 3.95
 F7414; 2x2.5VCT/6.5A 3.25
 6V/2.5A 1.75
 6.3VCT/7A, 6.3VCT/5A, 5VCT/6A, 3x6.3V/6.6.3 3.95
 F384A; 6.3V/2.5A, 2x2.5V/7A 3.25
 F112; 2x2.5VCT/6.5A, 2.5V/6.5A 4.25

PLATE TRANSFORMERS

P410; 800VCT/40Ma, 760VCT/500Ma. \$6.50
 690V/400VCT 4.95
 70V/1A 2.25
 P699; 2x300VCT/150Ma 2.25
 P413; 510VCT/150Ma, 650VCT/15Ma 3.00
 P842; 600VCT/166A, 625VCT/107A 2.95
 P885; 1620VCT/400Ma HV Ins. 11.95
 P894; 2x20V/350Ma, 2x20V/01A 1.95
 2x150V/940Ma 4.50
 246VCT/830Ma 3.95

COMBINATION TRANSFORMERS

780V/600Ma, 6.3/2 \$3.95
 825VCT/150VCT/3.5V/3 3.95
 C111; 2x300V/42Ma, 55V/125Ma, 45V/3.5Ma 3.95
 C608; 880VCT/150Ma, 5V/3A, 6.3V/6.25A 4.25
 C931; 585VCT/86Ma, 5V/3A, 6.3V/6A 3.95
 C055; 525VCT/75Ma, 5V/2A, 6.3/1.8, 10V/2A 4.45
 T102; 1080VCT/55Ma, 6.3/1.2, 6.3V/1.2A 5.95
 600VCT/150Ma, 6.3VCT/5A, 5VCT/3A 4.25
 C899; 2x110VCT/01A, 6.3V/1A, 2.5VCT/7A 4.50
 6.3VCT/10A, 65V-100V-40V-18VCT-18V-6V-6.3V/1A 5.25
 5VCT/3A, 580VCT/040A 2.95
 40V/01A, 6.3/1.25A 1.95
 T100; 1120VCT/770Ma, 590VCT/082A HV Ins. 12.50
 C579; 24V/900Ma, 2.7V/0.025, 2.5V/3A HV Ins. 4.25
 T378; 2300V/004A, 2.5/2A HV Ins. 7.95
 C360; 640VCT/080A, 5VCT/3A, 6.3VCT/3.2A 3.95

FILTER CHOKES

25Hy/65Ma \$1.00; 6Hy/150Ma 1.50
 Swing 15-29Hy/150 Ma \$3.25; 8.5Hy/125Ma 1.50
 Dual 7Hy/100Ma \$1.00; Dual 2Hy/100Ma 1.65
 Dual 2.5Hy/130Ma \$1.25; .16Hy/150Ma 4.25
 .01Hy/2.5A \$1.45; 35Hy/350Ma 7.25
 Dual .5Hy/380Ma \$1.00; 5Hy/40Ma .55
 2Hy/200Ma 75c; Dual 120Hy/17Ma 1.45
 30Hy/200Ma 85c; 5Hy/200Ma 1.45
 2.1Hy/200Ma \$1.20; 2x2.2Hy/55A 9.95
 25Hy/75Ma \$1.10; 20Hy/300Ma 7.95

Write for Lists of Many Others.



OIL FILLED CONDENSERS

.1-.1 MFD	7000 VDC	\$3.27, 2 for \$6.50
.1 MFD	6000 VDC	2.60, 2 for 5.00
.5 MFD	1000 VDC	57c, 2 for 1.00
.5 MFD	2000 VDC	\$1.15, 2 for 2.25
2x.5 MFD	1000 VDC	95c, 2 for 1.80
1 MFD	1500 VDC	87c, 2 for 1.30
2 MFD	1000 VDC	87c, 2 for 1.25
4 MFD	1000 VDC	87c, 2 for 1.45
6 MFD	600 VDC	65c, 2 for 1.25
7 MFD	800 VDC	95c, 2 for 1.80
15 MFD	1000 VDC	\$1.75, 2 for 2.50
1 MFD	1000 VDC	\$2.25, 2 for 4.50

WRITE FOR LIST OF MANY OTHERS INCL. HIGH VOLTAGE

XFMR TELEV PWR SUPPLY KITS
DEFLECTION YOKE for 5" to 12" Scope Tube, fully cased \$4.49
DEFLECTION YOKE E. Same as above. Phico. \$4.99
FOCUS COIL for above. W. E. D164915 \$4.25
BLOCKING OSCILLATOR, 15000 cy. Horiz. Rat 2:1. Freq. 85c
BLOCKING OSCILLATOR, 9318, 1:1:1, Ratio. \$1.50
BLOCKING OSCILLATOR, Turns Ratio 2:1. \$1.75
PULSE TRANS. RAY, UX 8092 2:1:1. \$1.75
SWEEP CHOKO, 3 Hy. 35 Ma. 250 ohms. Price 2 for.....75c
 Write for Lists of Other Equip.

TELEVISION COMPONENTS
BASIC 3" and 5" T.V. PWR SUPPLY
 Trans. 1080V/55Ma, 6.3V/1.2A, 6.3V/1.2A, 2-1 Mfd. 2500V, 2X2 100-000 ohm Resis. **\$9.95**
TV TRANSFORMER 3000V/5Ma, 720VCT/200 Ma, 6.4V/8.7A, 6.4V/6A, 5V/3A, 1.25V/3A. Fil & Plate Voltage for 7" & 8" Tube. Price.....\$9.95
TV TRANSFORMER 10,000V/5Ma for 12" Tube. Price.....\$10.95

VARIABLE FREQ OSCILLATOR CONDENSER

Precision 2 Sect. Isolantite Ins. Worm drive high gear ratio, First Sect 17 PI. .0625 GAP 0-150 Mmf/d, Second Sect 25 Mmf/d, .06 GAP 0-200 Mmf/d, Precision Trimmer Panel, 51 Adjustments **\$4.25**

VARIABLE 7 GANG
 Cardwell, Two 200Mmf, One 75Mmf Sect's, Worm Drive Assy and 0-30 Calib Dial 1/8" shaft, 1/8" Lvs. Price..... **\$1.95**

VERNIER 3 GANG
 Precision Assy used for single dial Control up to 75 watt, 2 single spaced 250Mmf Sect's & Heavy Double Spaced Sect's, 50:1 Ratio, Spring loaded Ceramic Ins. 4" **\$3.25**
Metal Dial..... \$2.25
VARIABLE ARC 5
 6-9.1Mc Condenser, 90:1 Drive Gear Ratio, 3 Sections. Price..... **\$2.25**

CERAMIC TRIMMER
 Stack of 6 Ceramic Trimmers 110-460Mmf. Can be used singly or ganged. **69c**

COMMUNICATIONS EQUIPMENT COMPANY
 CABLE ADDRESS: COMSUPO
 PHONE DIGBY 9-4124
131 LIBERTY ST. DEPT. N
NEW YORK 7, N. Y.
 E. C. MONEY BACK GUARANTEE, \$3 MIN. ORDER.
 P.O. B. N.Y.C. SEND MONEY ORDER OR CHECK, ONLY SHIPPING CHARGES SENT C.O.D.

PARTS CARNIVAL

CONDENSERS

SPEAKERS

VIBRATORS

CHANGERS

AUTO RADIO REPLACEMENT VIBRATORS

Type	Mallory	Replaces Radiart	Each
V1	294	5300	\$1.19
V43	854	5331	.69
V49	505P	5320P	.69
V71	249	5406	.89
V66	246	5411	.89
V5	245	5409	.89
V6	296	5306	.69

LIMITED QUANTITIES—ACT NOW

P. M. Speakers P. M.

ALL BRAND NEW—NO SECONDS

3" P.M. 1 oz. Alnico V. Mag.	\$0.89
4" P.M. 1 oz. Alnico V. Mag.	.99
5" P.M. 1 oz. Alnico V. Mag.	1.10
5½" P.M. 1½ oz. Alnico V. Mag.	1.49
6" P.M. 1½ oz. Alnico V. Mag.	1.69
8" P.M. 2.15 oz. Alnico V. Mag.	2.45
8" P.M. 21 oz. Alnico 3 Mag.	3.65
6"x9" P.M. 2.15 oz. Alnico V. Mag.	2.45
10" P.M. 4.7 oz. Alnico V. Mag.	3.65
12" P.M. 21 oz. Alnico 3 Mag.	4.95

SEEBURG Model L Record Changer

Finest 2-post record changer on market. Will play 12" and 10" or 10" and 12" records. Base size 14" square. Automatic shut-off after last record. Best Astatic Cartridge and Permanent Needle. A big bargain for only..... **\$17.95**

SEEBURG DS101 Record Changer on Base

Handles 10- or 12-inch records. Smooth, quiet action. Lightweight pickup arm with astatic Q-type cartridge and permanent needle—the right combination for high-fidelity reproduction. Handsome formed walnut-finish wood base 12½"x14¼". Complete with shielded cable and plug for connection to radio or amplifier, and line cord and plug for 110-V 60-cycle operation. Regular \$44.25. Now only..... **\$17.95**

STANDARD BRANDS CONDENSERS

Bi-Pass 600V Tubular Pigtail Types

.001	.6c each	.02	.6c each
.005	.6c each	.05	.7c each
.006	.6c each	.1	.8c each

(Deduct 10% in lots of 100—may be assorted)

Tubular Electrolytics

	Each	10 for
20-20 MFD—150V	39c	\$3.50
50-30 MFD—150V	58c	5.00
40-40 MFD—150V	48c	4.20
35-30 MFD—150V	45c	4.00
8-8 MFD—450V	58c	5.40
20-20 MFD—450V	79c	7.50

F. P. CONDENSERS

We have a limited quantity of F. P. Condensers in single, dual and triple sections, in various capacities and voltages. Large variety but small quantities of each. We offer them 10 assorted for \$2.00. An excellent value for the Serviceman.

ORDER FROM THIS AD!

Select what you need from the big values listed here—and send your order now! Quantities are limited. Send 25% deposit with order. We ship C.O.D. for balance, all advertised items F.O.B. Chicago. When remitting in full, include sufficient postage—overages refunded. GET YOUR NAME ON OUR MAILING LIST. We carry complete stock PA equipment—BOGAN, MASCO Amplifiers—Shure, Turner Mikes—University Speakers, etc. Write for complete list TODAY!

NATION WIDE RADIO
(The Serviceman's Supply House)
572 W. Randolph Street
CHICAGO 6, ILLINOIS

put of this same rectifier. In consequence, polarity of the brushes is independent of line polarity, whereas polarity of the field is directly determined by it. Thus, direction of rotation of the motor, so connected, is determined by line polarity.

This connection permits the use of a bridge controller, where close control of motor speed and direction is important, and power economy is not. This consists of a standard Wheatstone bridge circuit, with the galvanometer replaced by the line of Fig. 1C. The magnitude and polarity of the motor current is determined by that of the bridge unbalance. With some types of motors, this circuit will function on a.c., but speed control is very erratic, and under certain conditions, direction of rotation may be reversed by simply opening the circuit for a small fraction of a second. In consequence of the above experimental findings, use of alternating current in this circuit is not recommended.

An entirely different application of a rectifier is to confine inductive kicks (flybacks) to definite parts of the circuit. This trouble is particularly common when a large solenoid and several other devices are shunted across the far end of a long line. When the circuit is opened, the flyback of the large inductance may actuate, or even damage, the other devices. By use of a rectifier and spark absorber, as in Fig. 1D, these troublesome inductive

kicks can be kept out of the line. The neon bulb is included here to depeak the kick, so that the rectifier back-voltage rating need not be much greater than the firing voltage of the neon bulb.

This application is quite important in some installations, for the momentary flyback voltage of one very dependable 6-volt d.c. operations counter exceeds 150, and a pilot light shunted across the counter explodes when the circuit is opened. When a rectifier, neon bulb "surge eater," and a conventional RC spark absorber are used, as in Fig. 1D, a pilot light of suitable voltage, connected across the line on the line side of the rectifier, performs in the expected manner, and has a normal service life.

From the above summary it appears that dry-disc rectifiers furnish the ideal solution for a few control problems and are useful alternative devices in other control positions. Use of rectifiers will, in some instances, lead not only to a financial saving, but also to an increase in the over-all dependability of the control mechanism. Although these rectifiers, as now manufactured, have a very long life, often exceeding the factory rating by a factor of two or more, they are not immortal, and systematic checking of the condition of rectifiers is just as important as systematic contact servicing.

—30—

FIRST INDIAN RADIO ORGANIZATIONS

FOR the first time in the history of India, two radio organizations, the Amateur Radio Club of India (ARCI), and the Short-Wave League of India, have been established, at Mhow in central India, and at Bombay (P.O. Box No. 6666, Bombay 20), respectively.

The ARCI looks after the interest of all transmitting amateurs, and SWL was formed for non-transmitting members. They publish a combined month-

ly journal, "QRZ," the only amateur radio journal published in that country.

Both of these stations are non-commercial, run by honorary officers, and are very active on 7, 14, and 28 mc. bands. The call signs used are VU2-ARCI, and VU2SWL, and the headquarters stations are believed to be the finest and best equipped amateur stations in Southeast Asia.

—30—

Headquarters of the ARCI and SWL amateur radio stations, VU2ARCI and VU2SWL.

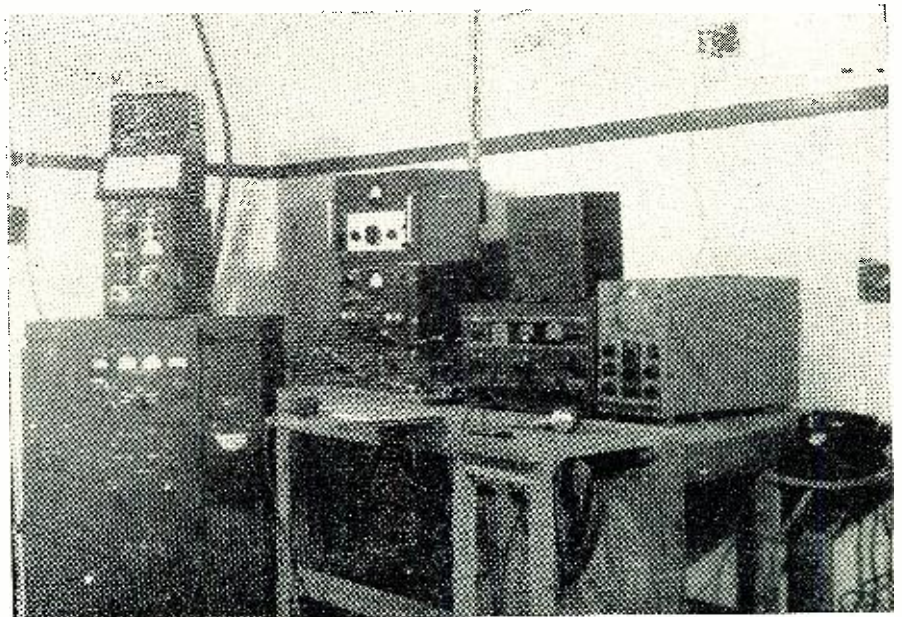

Amazing Offer in Television-Radio Service Manuals

New 1949 T-V Manual

Use this new giant "Cyclopedia" of television servicing as your guide to quick fault finding and repair of any modern T-V set. Easy-to-understand description of circuits, pages of test patterns, response curves, clear alignment facts, oscilloscope waveforms, voltage charts, service hints, many diagrams in the form of double-spread blueprints, everything to bring you up-to-date and make you an expert in T-V repairs. Factory data on every popular make. Large size: 8½x11", manual style binding, flexible covers. Amazing new **Supreme** super-value — easily worth three times the price of only..... **\$3**

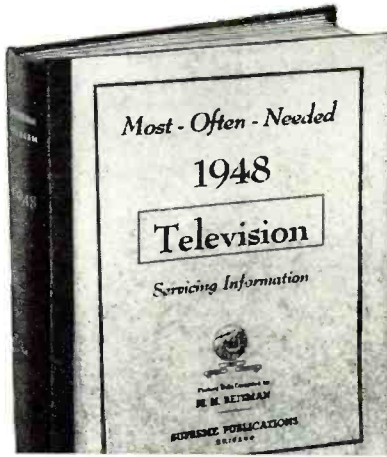

1948 TELEVISION

In this mammoth volume you have practical factory service data on 1948 sets of Admiral, Belmont, DuMont, Farnsworth, G.E., Hallicrafters, Motorola, Philco, R.C.A., Sonora, Stromberg-Carlson, and others. Practical information eliminates all guesswork in T-V repairs. Tells you how to make tests, what adjustments to make, probable trouble spots, location of all trimmers and controls. All the newest servicing and alignment techniques are included. If you are tired of pure theory and want practical facts, this is the manual that will guide you to quick T-V success. Includes hundreds of charts, waveforms, photographs, and many large 11x17-inch blueprints. Available at your radio jobber, or send coupon, special price of only..... **\$3**

1947 F.M. & T-V

Use this manual of factory instructions for trouble-shooting, repairing, and alignment of all 1947 popular **Television** and **F.M.** sets. Covers every popular make, including F.M. tuners, AM-FM combinations, and all types of modern television receivers. Detail circuit diagrams, theory of operation, test hints, alignment data. This is the material you need to fix F.M. or Television sets. Don't turn this profitable work away for lack of knowledge and information. Data on 192 large pages, 8½x11 inches. Sturdy, manual-style binding. Tremendous **Supreme** value at only..... **\$2**

New 1949 Diagram Manual added to SUPREME PUBLICATIONS



ALL RECENT SETS IN NEW 1949 MANUAL

Use this new manual to repair quickly all modern **1949** radio receivers. In this big single volume, you have clearly-printed, large schematic diagrams, needed alignment data, replacement parts lists, voltage values, and information on stage gain, location of trimmers, and dial stringing for almost all recently released sets. A worthy companion to the 8 previous volumes used by over 128,000 shrewd radio servicemen. Like the previous volumes illustrated above, it sells at a give-away price and gives you a whole year of radio diagrams for a couple of dollars total cost—nothing else to buy the rest of the year, nothing else to pay. Giant size: 8½x11 inches. Includes index. Manual style binding. Available at your jobber, or send coupon, price only..... **\$2.50**

SENSATIONAL LOW PRICE

Be money ahead with **SUPREME Manuals**. For the remarkable bargain price (only \$2 for most volumes) you are assured of having in your shop and on the job, needed diagrams and other essential repair data on 4 out of 5 sets you will ever service. There is no need to spend large sums for bulky, space-wasting manuals of other publishers, or to buy additional drawings every few weeks; be wise, use **SUPREME Manuals** to get the most in diagrams for the smallest cost. Check manuals wanted on the "no-risk" coupon.



Compiled by M. N. Beltman, radio engineer, teacher, author & serviceman.

AMAZING BARGAIN IN SERVICE DATA

Here is your low-priced, money-saving source of radio diagrams and service data for all popular sets. Above is a photograph of these giant-size manuals—available to radio servicemen at only \$2 for most volumes. Let these easy-to-use manuals guide you to quick fault finding and simplified repair of any radio. Eliminate guesswork, cut hour-wasting jobs to pleasant moments. For 16 years, radio servicemen expected and received remarkable values in **Supreme Publications** service manuals. Yes, these manuals are still only \$2 each, and \$2.50 for the new 1949 manual and the extra large 1926-38 volume. Biggest bargain in service manuals.

USE THESE MANUALS AND BE AN EXPERT

Service all radios faster, better, easier, save time and money, use these **most-often-needed** diagram manuals to get ahead, earn more per hour. These manuals cover every popular radio of all makes, from old timers to new 1949 sets. Clearly printed circuits, parts lists, alignment data, and helpful service hints are the facts you need to be more expert in radio servicing. Save hours each day, every day, begin to earn more by making repairs in minutes instead of hours. Let these inexpensive manuals give you needed diagrams for 80% of all sets. These manuals pay for themselves with time saved on a couple of jobs, after that you use them **FREE**. There are nine volumes in all as illustrated above. Each manual is 8½x11 inches, sturdy manual style binding, average manual has 194 pages of diagrams and practical service data. Use coupon below to order on 10-day no-risk trial or see these manuals at your jobber.

Record Changers Post-War Manual

Service expertly all modern (1945-1948) record changers. Includes every popular make. Just follow simplified factory instructions to make needed adjustments and repairs. Hundreds of photographs and exploded views. Large size: 8½x11 inches. 144 fact-filled pages. Available at your radio jobber, or sent postpaid, only..... **\$1.50**

Radio Servicing Course-Book

Here is your practical radio course of 22 easy-to-follow lessons. Review fundamentals, learn new servicing tricks, all about signal tracing, oscilloscopes, recording, P.A., test equipment, and T-V. Just like a \$100.00 correspondence course. Everything in radio servicing. With self-testing questions and index. Large size: 8½x11". **\$2.50** Price postpaid, only



New 1949 Edition

NO RISK TRIAL ORDER COUPON

SUPREME PUBLICATIONS, 3727 W. 13th St., Chicago 23, ILL.

Ship the following manuals on 10-day trial under your guarantee of satisfaction.

- New 1949 Television Manual..... \$3.00
- 1948 Television Manual..... 3.00
- 1947 F.M. and Television..... 2.00
- Post-War Record Changers..... 1.50
- Radio Servicing Course-Book... 2.50

Most-Often-Needed Radio Diagram Manuals
 New 1949 Manual, \$2.50
 1948
 1947
 1946
 1942
 1941
 1940
 1939
 1926-1938 — \$2.50

PRICED AT ONLY \$2 EACH

- I am enclosing \$....., send postpaid.
- Send C.O.D. I am enclosing \$... deposit.

Name:

Address:

Supreme Publications

Sold by all Leading Radio Jobbers

July, 1949

85



FORCED TO HOLD OVER—BY POPULAR DEMAND!

When we advertise 'em—we got 'em!
TRANSMITTERS—ARC-5 & ATA

Lenny is shedding bitter tears at the ridiculously low price. But Buck says: "Let 'em have it!" So here it is:

4-5.3 Mcs. **\$2.99** ea. 5.3-7 Mcs.

Complete with tubes and crystals in good condition. Get 'em while they last!

FAMOUS "ARB" RECEIVER

195 to 9,050 Kcs. Controlled by a 4-band selector switch. Features include 6 tubes, 3 micro-volt sensitivity MVC or AVC CW or MCW—sharp or broad tuning for extra sensitivity. 28V dynamotor. Used but in excellent condition. **Special! \$19.95**

"ARB" DUAL CONTROL BOX

Brand new!.....Ea. **\$2.49**

TBY VIBRATOR POWER SUPPLY

4 volt input. 156 volts for plate 3 volts, 1.5 volt, -7½ volts. With polarity switching relay. Has adapter for charging from 6 V. supply. It's terrific for portable battery sets, mobile units and small transmitters. Excellent condition. A \$20.00 value for **\$8.95** only.....

2 V. WILLARD WET CELL BATTERIES

Excellent for use with TBY Vibrator Power Supply (above). Brand new, individually boxed. Ea. **\$1.49**.
Order 2 for only.....**\$2.75**

BC-347 INTERPHONE AMPLIFIER

200 ohm to p.p. grids and p.p. plates to 200 ohm line. Has 2 excel. ounce trans. With 6F8 Tube in aluminum case. Brand new!
Individually boxed.....Ea. **\$1.49**

TUBES!!! TUBES!!!

ALL BRAND NEW IN ORIGINAL BOXES!

RX21 MERCURY VAPOR, half-wave rectifier. 11,000 V. peak inverse at 3 amps. Constant output at 1.5 amps. Mounts in standard 5-pin socket..... **\$ 1.95**
5BP4..... **2.95**
5CP1..... **1.50**
12DP7 New Low Price!..... **10.95**
21L..... **.29**
304TL Special!..... **.75**
316-A (Doorknob tube)..... **.39**
371-A or 371-B..... **.99**
1616..... **.69**

PORTABLE BC-659 TRANSCEIVER

27 to 38.9 Mcs. Crystal controlled, battery operated, power supply 6, 12, or 24 V. Complete (less power supply) with all tubes, 2 crystals, hand sets and antenna.....**\$17.50**
Used but excel. cond.....

SUPER SPECIAL !!!!!

NEVER BEFORE SO MUCH FOR SO LITTLE!

Approx. 16 (sixteen!) lbs. of radio parts. EACH PACKAGE CONTAINS: transmitter, pots, condenser, crystal, knobs, switches, transformer, choke, insulators, PLUS brand new 10-ft. 3-cond. rubber covered cord. Absolutely no junk, no hardware. All good, useful parts. A \$14.50 value. All of them—yes, **\$3.50**
ALL for only.....

Send for our **NEW FREE Catalogue** These prices are good for month of July only! All prices F.O.B. Los Angeles. 25% deposit with order. Balance C.O.D. Minimum order \$2.00.

Come in and see the **LARGEST** supply of surplus in the **BIGGEST** electronics warehouse on the West Coast!

COLUMBIA ELECTRONICS

522-524 South San Pedro Street
LOS ANGELES 13, CALIFORNIA

SAVE TESTING TIME With an "Outlet Box" Unit

Eliminate makeshift hook-ups — ordinary outlet boxes can be used to make a convenient test unit.

By

HARRY LEEPER

THE radio service technician often finds it desirable to insert a fuse, lamp, resistor, or other device in series with the supply line to a radio or appliance for test purposes.

To eliminate make-shift hook-ups for such tests the "outlet box" unit illustrated here was assembled. It has been found convenient for many tests and may easily be carried in the service kit or used on the test bench.

Two 3¼ inch octagon metal outlet boxes were bolted together after the center back knockouts were removed. A cover for one box carries a standard duplex receptacle, while the other cover has a single standard socket. (See Photo 1.)

The receptacle and socket are wired in series, and a line cord is attached through a knockout. The unit is shown plugged into a wall outlet in Photo 2.

It may be used as ordinary extension outfit by inserting a plug fuse in the socket (Photo 3) and attaching the

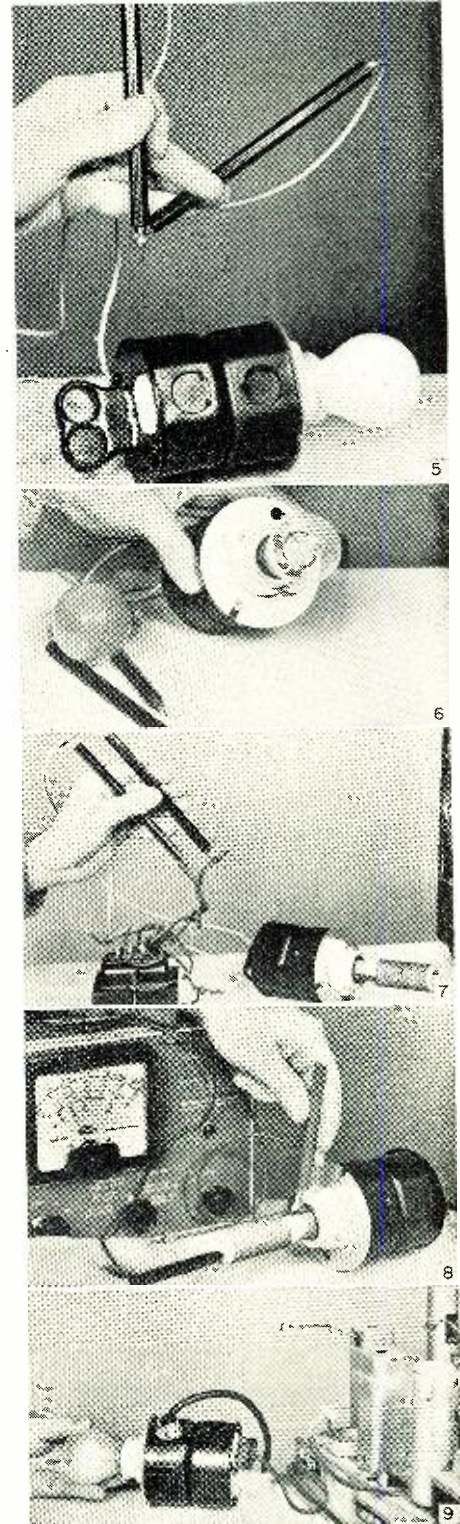

SELENIUM RECTIFIERS

— and —
ELECTRONIC COMPONENTS

THREE PHASE BRIDGE RECTIFIERS

Input 0-126 VAC	Current	Output 0-130* VDC	Price
Type #			
3B7-4	4 AMP.		\$32.95
3B7-6	6 AMP.		48.90
3B7-15	15 AMP.		70.00

Input 0-234 VAC	Current	Output 0-250* VDC	Price
Type #			
3B13-4	4 AMP.		\$56.00
3B13-6	6 AMP.		81.50
3B13-15	15 AMP.		120.00

CENTER TAPPED RECTIFIERS

Input 12-0-12 VAC	Current	Output 0-8* VDC	Price
Type #			
C1-10	10 AMP.		\$6.95
C1-20	20 AMP.		10.95
C1-30	30 AMP.		14.95
C1-40	40 AMP.		17.95
C1-50	50 AMP.		20.95
C1-80	80 AMP.		26.95
C1-120	120 AMP.		34.95

CUSTOM DC POWER SUPPLIES

Built to your specifications.
Fort

- INDUSTRY
- LABORATORIES
- UNIVERSITIES
- GOVERNMENT AGENCIES

We will be pleased to quote on
your requirements.

* Select Proper Capacitor to Obtain Higher DCV Than Indicated.

VACUUM CAPACITORS



Standard Brands			
12 Mmfd.	20 Kv		\$4.95
50 Mmfd.	20 Kv		4.95
50 Mmfd.	32 Kv		5.95

SILVER CERAMIC TRIMMERS

Type			
820-Z	5-20 Mmfd Zero Temp.		24c
822-N	5-20 Mmfd Neg. 300.		24c
822-AZ	4.5-25 Mmfd Zero Temp.		24c
823-AN	20-125 Mmfd Neg. 650.		33c

VARIABLE AIR TRIMMERS

Standard Brands—Screw Driver Adj.

	Lots of 10	Lots of 100
7.5 MMF	\$2.90	\$27.00
25 MMF	3.10	29.00
50 MMF	3.30	31.00
100 MMF	4.10	39.00
140 MMF	4.90	47.00

ATTENTION!!!

INDUSTRIALS, EXPORTERS, SCHOOLS, GOV'T.
AGENCIES, LABORATORIES

Our engineering staff is at your service to facili-
tate the application of rectifiers to your specific
requirements.

Write for quantity discounts on company letterhead.

FULL WAVE BRIDGE RECTIFIERS

Input 0-18VAC	Current	Output 0-13*VDC	Price
Type #			
B1-250	250 MA.		\$0.98
B1-500	500 MA.		1.95
B1-1	1 AMP.		2.49
B1-1X5	1.5 AMP.		2.95
B1-3X5	3.5 AMP.		3.95
B1-5	5 AMP.		5.95
B1-10	10 AMP.		9.95
B1-15	15 AMP.		13.95
B1-20	20 AMP.		15.95
B1-30	30 AMP.		24.95
B1-40	40 AMP.		27.95
B1-50	50 AMP.		32.95
B1-60	60 AMP.		36.95
B1-80	80 AMP.		44.95

Input 0-36VAC	Current	Output 0-26*VDC	Price
Type #			
B2-150	150 MA.		\$0.98
B2-250	250 MA.		1.25
B2-300	300 MA.		1.50
B2-450	450 MA.		1.95
B2-1	1 AMP.		3.95
B2-2	2 AMP.		4.95
B2-3X5	3.5 AMP.		6.95
B2-5	5 AMP.		9.95
B2-10	10 AMP.		15.95
B2-15	15 AMP.		24.95
B2-20	20 AMP.		27.95
B2-30	30 AMP.		36.95
B2-40	40 AMP.		44.95

Input 0-54VAC	Current	Output 0-40*VDC	Price
Type #			
B3-150	150 MA.		\$1.25
B3-250	250 MA.		1.95
B3-600	600 MA.		3.25
B3-5	5 AMP.		13.95
B3-10	10 AMP.		24.95

Input 0-72VAC	Current	Output 0-54*VDC	Price
Type #			
B4-600	600 MA.		\$3.95
B4-3	3 AMP.		14.95
B4-5	5 AMP.		17.95
B4-10	10 AMP.		32.95

Input 0-115VAC	Current	Output 0-110*VDC	Price
Type #			
B6-150	150 MA.		\$1.95
B6-250	250 MA.		2.95
B6-1	1 AMP.		7.95
B6-3X5	3.5 AMP.		18.95
B6-5	5 AMP.		24.95
B6-10	10 AMP.		36.95

Input 0-234VAC	Current	Output 0-180*VDC	Price
Type #			
B13-600	600 MA.		\$12.95
B13-1	1 AMP.		16.95
B13-3	3 AMP.		35.95
B13-5	5 AMP.		54.95
B13-10	10 AMP.		69.95

OIL CONDENSERS

2 Mfd. 200VDC Bathub		\$0.20
.5 Mfd 400VDC		.20
2 Mfd 400VDC Bathub		.30
2X.1 Mfd 600VDC		.39
6 Mfd. 600VDC w/mtg. clamp.		.79
10 Mfd 440VAC/1500VDC		1.55
8 Mfd 660VAC/2000VDC		3.50
.15-.15 Mfd 8000VDC Voltage Doubler		3.95

ELECTROLYTIC CONDENSERS

Cap.	WV DC	Each	Lots of 10	Lots of 100
100 Mfd	50	\$0.27	\$2.20	\$19.00
40 Mfd	150	.23	1.80	17.50
8-8-20 Mfd	350/150	.40	3.50	30.00
20-20 Mfd	400/250	.35	3.00	25.00
10 Mfd	450	.30	2.50	20.00
15 Mfd	450	.30	2.50	20.00
40 Mfd	450	.50	4.20	36.00

Minimum order \$3.00. No C.O.D.'s
under \$25.00. 25% deposit on C.O.D.
Add 10% for Prepaid Parcel Post and
Handling. Terms: Net 10 days in the
presence of approved credit.

All prices subject to change without notice.

Orders Promptly Filled from Our Stocks
All Prices F.O.B. our NYC Warehouse

RECTIFIER CAPACITORS

CF-13	6000 MFD	10VDC	\$2.49
CF-14	3000 MFD	12VDC	1.69
CF-15	6000 MFD	12VDC	2.95
CF-1	1000 MFD	15VDC	.98
CF-2	2000 MFD	15VDC	1.69
CF-20	2500 MFD	15VDC	1.95
CF-3	1000 MFD	25VDC	1.25
CF-4	2X3500 MFD	25VDC	3.45
CF-5	1500 MFD	30VDC	2.49
CF-6	4000 MFD	30VDC	3.25
CF-7	3000 MFD	35VDC	3.25
CF-8	100 MFD	50VDC	.98
CF-19	500 MFD	50VDC	1.95
CF-16	2000 MFD	50VDC	3.25
CF-9	200 MFD	150VDC	1.69
CF-10	500 MFD	200VDC	3.25
CF-11	100 MFD	350VDC	2.25
CF-12	125 MFD	350VDC	2.49

RECTIFIER TRANSFORMERS

All Primaries 115VAC 50/60 Cycles

Type #	Volts	Amps.	Price
XF15-12	15	12	\$3.95
TXF36-2	36	2	3.95
TXF36-5	36	5	4.95
TXF36-10	36	10	7.95
TXF36-15	36	15	11.95
TXF36-20	36	20	17.95
XFC17-10	17VCT	10	4.95

All TXF Types are Tapped to Deliver 32,
34, 36 Volts. XFC Type is Tapped to Deliver
15, 16, 17 Volts Center Tapped.

RECTIFIER CHOKES

Type #	Amps.	Price
HY5	.02 Hy	5
Dimensions: 3/4" Hx3" Dx3 1/2" W. Wt. 5 lbs. Hermetically Sealed.		

Type #	Amps.	Price
HY8X5	.02 Hy	8.5
HY10	.02 Hy	10
HY12	.02 Hy	12
HY15	.015 Hy	15

RECTIFIER MOUNTING BRACKETS

For Types B1 through B6, and
Type C1 \$0.35 per set
For Types B1370 per set
For Types 3B 1.05 per set

RECTIFIER KIT

6 and 12 VDC at 10 Amps.
This unit will deliver unfiltered direct current
for operation of motors, dynamotors, sole-
noids, electroplating, battery charging and
similar equipment.

The following components are supplied:

- 1 ea. Full Wave Bridge Rectifier
- 1 pr. Rectifier Mounting Brackets
- 1 ea. Transformer 115 VAC 50/60 CPS.
- 3 ea. Silver-Plated Binding Posts
- 1 ea. 4-Position Tap-Switch
- 1 ea. Fuse and Fuse Holder
- 1 ea. Line Cord and Plug

The primary of the transformer is multi-
tapped permitting adjustment of the DC
output voltages.

Complete with schematic dia-
gram \$15.95

Filter Kit
for above \$3.50

SYNCHRO MOTORS

Type 1F Special—KS-5949, L1 Western
Electric.
115/90 VAC—400 Cycles.
Price Each \$8.00

OPAD-GREEN COMPANY

71 Warren St.
New York 7, N. Y.

Phone: BEekman 3-7385-6

SPECIALS

FT-237 MOUNTING Base for BC-604 and 603's and for BC-684 and 683's. **\$9.95**

RC-298 INTERPHONE EXTENSION KIT. **\$49.50**

BLOWER—110 Volt 60 cycle, 4" intake 2" outlet. Approx. 100 cu. ft. dis. Motor size 3" x 3" —1750 RPM. NEW. **\$6.95**
Motor ONLY. **3.95**

MP-22 MAST BASE

Mounting with spring action and mounting bracket insulated at top to receive modified MS-53 Mast Section listed below. Mast Base only. **\$2.95**

MAST SECTIONS: For above MP-22, tubular steel, copper coated, painted—in 3 foot sections. Bottom section MS-53 can be used to make any length. MS-52-51-50-49 for taper. Screw-in type. Any section.
Price **\$0.50 ea.**

SELSYN TRANSMITTER & INDICATOR SYSTEM—Ideal as radio beam position indicator for Ham, Television, or Commercial use. Complete with 5 inch 1-82 Indicator, Autosyn Trans., 12 Volt 60 cycle Transformer, and wiring instructions.
Price NEW **\$7.95**
PL-115 PLUG I/I-82, \$1.00 Autosyn Trans. **\$2.95**

SELSYN No. C-78248—115 Volt AC 60 cycle. Size V 3 1/2" x 5 1/2". Can be used to turn small antennas or for position indicator systems.
Price per Pair **\$5.95**

SELSYN 21G1—WITH CAPS—Can be used as position indicator for antennas; 110 Volt 60 cycle, with instructions. Normally operates from 57.5 Volts 400 cycle. Price per Pair **\$3.00**

TRANSFORMERS—110 Volt 60 Cycle Primaries:

Sec. 12 V.	1 amp.	\$1.50
Sec. 24 V.	1 amp.	1.95
Sec. 24 V.	.5 amp.	1.50
Sec. 36 VAC	2.5 amp.	2.95
Sec. 14-14 or 28 Volt	7 1/2 or 15 amp.	4.95

DYNAMOTORS and INVERTERS

Input	Output	Stock No.	Price
12 V DC	220 V 100 MA	D 402	\$3.95
12 24 V DC	440 V 200 MA and 220 V 100 MA	D 104	9.95
24 V DC	400 Cycle Inverter	MG-149F	14.95
13/26 V DC	F/BC-645	PE 101	2.95
12/24 V DC	500 V 50 MA	D 0515	2.95
28 V DC	3/Comm. Receivers	DM 32	1.95
14 V DC	230 V 400 MA	DM 20	3.95
9 V DC	450 V 60 MA with Blower	D 9450	3.95

Available: MARK II #19 Sets and Accessories!
Address DEPT. RN • Minimum Order \$2.00 • Prices F.O.B., Lima • 25% Deposit on C.O.D. Orders

COMMAND RECEIVER AND TRANSMITTER SETS AND ACCESSORIES

BC-454 3 to 6 MC. USED. **\$5.95**
BC-453 6 to 9.1 MC. USED. **5.95**
DYN-6V. Can be used for Comm. Rec #0515. **2.95**
TRANSFORMER NH-109 for Comm. Rec. In-put 115 VAC 60 cycle; output 250-0-250 VAC at 60 MA. 24 VAC at .6 amps; 6.3 VAC at .6 amps. NEW. **3.00**

TRIPLE REC. RACK—black. **1.95**
TUNING CRANK or Knob. **1.95**
CONTROL BOX BC-450. **1.50**
CONTROL BOX BC-451. **1.50**
BC-453 5.3 to 7 MC. NEW. **\$8.95**; USED. **5.95**
T/20 4 to 5.3 MC. NEW. **\$9.95**; USED. **6.95**
BC-456 MODULATOR—Like New. **2.50**
DUAL TRANSMITTER RACK—New. **1.50**
TRANSFORMER NH-108 for Comm. Trans. In-put 115 VAC 60 cycle; output 600-0-600 VAC at 250 MA. 12 VAC at 3 amps; 12 VAC at 3 amps and 5 VAC at 3 amps. NEW. **6.90**
BC-442 Antenna Relay Box w/cond. New. **2.95**

C POWER SUPPLY AND SPEAKER

Completely wired power supply and speaker with volume control C.W. and on-and-off switch, housed in metal cabinet. For Command receivers with connections to plug into receiver and 110 Volt 60 cycle line. Voltage output: 250 V. 60 MA., 6.3 V. .6 amp and 24 V. .6 amp. Price: Completely wired. **\$14.95**
Kit of Parts. **9.95**

GN-45 GENERATOR—ONLY, USED. \$5.00
LEG & SEAT Assy. For Hand Generators **2.75**
CRANKS for Hand Generators **.75 Ea.**

MISCELLANEOUS

TU-17 or 25 for BC-223—Price: NEW **\$4.50**
Coaxial Cable—125 OHM cotton covered—50 Ft. **1.00**
Coaxial Cable—72 OHM Rubber covered—8 Ft. **.50**
Cable—4 conductor. Rubber covered, shielded—50 Ft. **2.00**
Wire—Heavy duty 2 cond. Rubber covered #14 stranded. 20 Ft. **1.00**
Wire—2 Cond. Rubber covered Tflex #16. Per Ft. **.06**

BC-645 A Transceiver. **14.95**
AC-Meter 150 Volt 400 Cycle 2". **3.95**
Cable for BC-223 w/PL-150 each end. **1.75**
Plugs for BC-375—PL-64 or PL-59. **1.55**
Cable for BC-375 w/PL-61 each end. **1.75**
Cable for TCS EQ/5377, 65110, or 65P13. **2.95**
Autosyn RPM Indicator 3500's. **4.95**
Autosyn Fuel Pressure Indicator. **4.95**
Plugs for LP-21 Loop, PL-112 or PL-108. **1.00**
FL-8 Filter 1200 CPS. **1.75**
BC-1023 Marker Beacon Rec. with tubes. **3.75**
BC-301 Marker Beacon Rec. less tube. **1.95**
BB-54 2 Volt Dry Cell Battery. **1.95**
BC-778 Gibson Girl Receiver—Only. **4.95**
CD-365 Cord for LP-21 Loop. **1.50**

radio to either section of the duplex receptacle, as the fuse closes the series circuit.

If the radio is thought to be defective, a fuse of 3 or 6 ampere rating may be used, which should open without disturbing the house or shop fuses. Small glass fuses may be used in like manner by attaching a fuse holder to a cap and wiring to the cap prongs. A plug is first screwed into the socket in this case (Photo 4).

By connecting test leads to a cap and plugging same into the receptacle, a continuity tester is available with a lamp in the socket (Photo 5). The current drawn through the circuit under test will depend mainly on the lamp used. A neon lamp may be substituted for the ordinary lamp (Photo 6). This will limit the flow of current.

On other tests, such as the filament winding of a transformer, it might be desirable to draw considerable current for a short time. In such case a screw-in type of heating element might be used instead of the lamp (Photo 7).

This same heating element may be used in series with a radio (Photo 8) to give an indication of the volt-amperes taken by the radio by reading the voltage drop across the heater unit and applying Ohm's law, since the resistance of the heater unit would be measured and known.

A 25- or 40-watt lamp is easily used in series with a radio transformer and wiring (tubes removed) to check for a shorted or grounded transformer (Photo 9). The lamp should be very dim if the transformer is in good condition.

—30—

CLEAN THOSE KEY CONTACTS

BY HARRY C. AICHNER, JR.

SEVERAL pieces of heavy paper, such as wrapping paper, cut to 3 by 3/4 inches in size, will permit cleaning of your code key contacts without taking the unit apart.

Apply a very thin coating of silver polish to the middle of both sides of the paper, and then draw one sheet at a time back and forth between the key contacts, as you apply light pressure to the key knob. When the paper appears soiled, use the second piece, and so forth. This will insure removing all of the grime on the contacts.

A word of caution: don't overdo the job—you might wear off the pure metal contact points, especially if it is a comparatively inexpensive key you're using.

—30—



RADIO & TELEVISION NEWS

FAIR RADIO SALES 132 SOUTH MAIN ST. LIMA, OHIO

Emergency
ELECTRIC POWER
For A.M., F.M., and Television Stations

ONAN STANDBY ELECTRIC PLANTS

Model 10 EL
10,000 watts

PORTABLE A.C. ELECTRIC PLANTS FOR FIELD AND MOBILE RADIO

Supply power for transmission at scene of events. Can be carried by hand or in trunk of car. Take up only a few square inches of space in mobile unit. Weigh as little as 80 pounds. Lightweight models: 350 to 3,000 watts. Other models to 35,000 watts.

Stay on the air during power failures. When storms, floods, or breakdowns interrupt electric service to your station and force you off the air, you lose listeners, you lose income. Protect yourself against loss... make sure of your ability to provide vital service to your community during disaster periods by installing a dependable Onan Emergency Electric Plant.

An Onan plant will take over the job of supplying electricity for studios and transmission automatically when power is interrupted. Plant stops itself when power is restored. Upkeep costs are negligible.

Write for Folder or Engineering Service

D. W. ONA & SONS INC.
4801 Royalston Avenue, Minneapolis 5, Minnesota

Sectional TV Tower

(Continued from page 55)

filled in and inspected for cracks before the tower is put up. A couple of coats of aluminum paint will protect the metal from the weather and add to the appearance of the finished product.

Forty feet of half-inch thin-wall tubing will be required for each section. Three ten-foot lengths form the sides, and the other ten-foot piece should be cut up into fifteen pieces eight inches long to form the triangular braces. A piece of sheet metal should be cut to form a base for the bottom section, and two triangular pieces must be made with a center hole for mounting the antenna mast to the top section of the tower. This detail is shown in Fig. 1. The center hole can be cut with a cold chisel or a torch, and should be just the right size to pass the pipe or tubing used for a mast. Usually one-inch or one-and-a-quarter-inch thin-wall conduit will be satisfactory as a mast to mount the antenna array if no such piece of tubing is furnished with the antenna. If a motor is not being used, some simple lock must be made to keep the antenna from turning with the wind after it has been rotated to the correct position. Drill a couple of holes for large cotter pins or stove bolts in the upper mast, and these can rest against the triangular plates if no thrust bearing is planned.

To assemble the ten-foot sections, either use short pieces of solid rod inserted inside the two sections of tubing where they join together, or use standard slip joint fittings designed for the thin-wall conduit. Either method will make a rigid assembly when brazed together.

Round the ends of the eight-inch lengths of tubing to fit the one-half-inch conduit, using a grinding wheel or a large rat tail file. This is not absolutely necessary, but it will make a better job, and the joints will be easier to braze. The one-half-inch tubing can be conveniently cut with either a hacksaw or a regular tubing cutter. The tubing cutter is to be preferred, as sawing the thin tubing is a little hard on hacksaw blades.

For heights up to thirty feet, a single set of guy wires will be enough, but for greater heights, a double sys-

Fig. 2. A temporary brace and rope should be used to raise the tower.

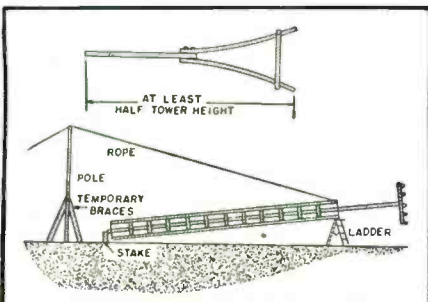

A ready-to-use TV set—NOT A KIT! PLUG IT IN... AND IT WORKS!

COMPLETELY WIRED DIRECT VIEW

29 TUBE CHASSIS FOR 12½" TV TUB

affording big 90 sq. in. picture television

FACTORY ENGINEERED, ALIGNED AND TESTED

STANDARD
RMA
GUARANTEE

\$169⁵⁰
LESS C R T

plus \$2.25 Fed. Tax

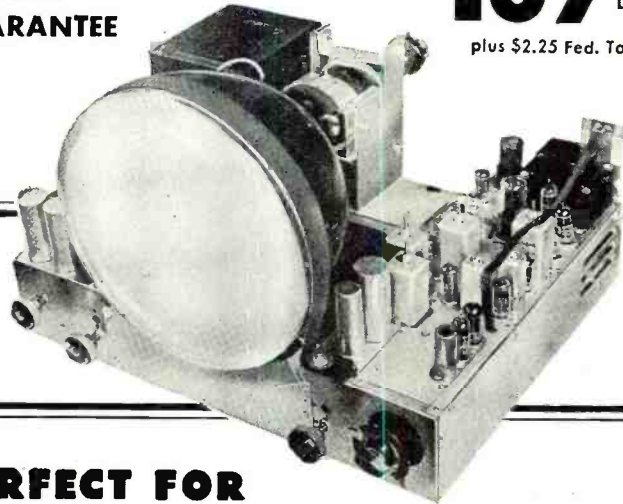

PERFECT FOR CUSTOM-BUILT INSTALLATIONS

CHASSIS WIRED FOR 15" or 16" OPERATION — (30 TUBES — 13000 VOLTS)
\$179.50 (LESS C R T) plus \$2.25 Fed. Tax

This compact TV chassis, with licensed RCA circuits, incorporates new improvements that provide excellent reception even in fringe areas... the same receiver is used in combination sets that sell as high as \$900 at retail! It represents unexcelled value!

13 channel tuning, long range reception, 29 tubes (3 rectifiers), front focus control, high gain audio amplifier, automatic frequency control, new improved daylight viewing, and many other high-calibre features found only in highest-priced sets.

No technical knowledge required to operate... just plug it in to get those sharp, clear images you've always wanted.

TV TUBES AT LOWEST PRICES:

12" CRT	\$39.95
15" CRT	61.95
16" CRT	63.95

Also at low factory prices: high fidelity AM and FM tuners and amplifiers, speakers, record changers and decorator-finish TV or combination cabinets.

WHY PAY MORE?

BUY DIRECT FROM THE FACTORY AND SAVE!

Send for our literature and prices — and COMPARE!

Phone and mail orders filled on receipt of certified check or money order for \$25 as deposit... balance C.O.D., F.O.B., N. Y.

For free demonstrations, visit our factory showroom

LEHIGH TELEVISION COMPANY

601 West 26th Street, New York 1, N. Y., Dept. H

Telephone: ALgonquin 5-2046

Prices subject to change without notice.

BUILD AND SAVE WITH RADIO KITS

Complete Kits Plus Detailed Instructions Give You Top Value and Quality!

Sensationally New!

Band-Pass TRF TUNER

With Germanium Diode Detector

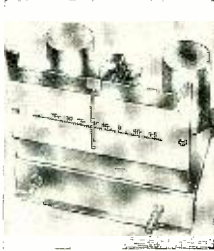

No tubes, no power supply, no hum! Use it with any amplifier and speaker system for high fidelity reception. 2-tuned circuit. Audio output 0.5V to 5V. Band width 25 Kc. All parts included, nothing else to buy. Ask for KIT MODEL TRF-34. **\$9.75** only.....

SWEEP GENERATOR

Assemble this kit now and be ready for FM and TV servicing! 5 tube circuit. Covers 2 Mc. to 228 Mc. 110V AC. Supplies RF or FM. Variable sweep width 0 to 10 Mc. Large dial. Variable phasing control. Ask for KIT MODEL SW5. **\$22.95** only.....



\$22.95

Attention Importers, Exporters, Foreign Users!

Battery Operated 3-Band Receiver Kit



Enjoy both standard and high frequency broadcasts with this superb receiver. Powerful battery power pack. Tuning range 540 to 720 Kc. 2.3 to 7.1 Mc. 7.3 to 22 Mc. 1N5, 305. Alnico V PM speaker. Complete with handsome cabinet. Easy to assemble! Ask for KIT MODEL 47-3X.

PRICES QUOTED ON QUANTITY ORDERS!

SIGNAL GENERATOR



150 Kc. to 34 megacycles on fundamentals. Can be extended to cover over a 100 megacycle range on strong harmonics. 110V AC power supply. 400 cycle oscillation may be used internally for modulating the signal or externally for audio testing purposes.

Ask for KIT MODEL SG2.

\$18.95 only.....

VACUUM TUBE VOLTMETER

6SN7 bridge type voltmeter circuit. 0-500 microamps DC 4 1/2" square meter. 11 megohms DC. 6.5 megohms AC input resistance. .01 ohms to 1000 megohms in 5 ranges. Linear AC-DC volts 0-1000 volts. 5 scales. 6H5 balanced linear diode AC rectifier. 1% precision resistor. The perfect instrument for signal tracing and dynamic testing. Ask for KIT MODEL Q12. **\$23.95** only.....



Combination Kit for High Voltage and High Frequency Testing. Complete outfit includes Kit Model Q12 plus two probes. High Frequency Probe up to 10 KV and High Voltage Probe up to 100 Mc and over. Ask for KIT MODEL Q12-X. **\$29.95** only.....

ALL KITS SOLD LESS SOLDER AND WIRE FREE—Send for Catalog P of All Radio Kits

RADIO KITS COMPANY

120 Cedar Street New York 6, N. Y.

If Kits Are Not Available at Your Local Supplier, Write to Us Giving Supplier's Name

Jobber and Export Inquiries Invited!

90

tem of guys should be used. In any case, use enough guys to support the mast and allow for breakage of one or two of them in an emergency. It is better to have too many guy wires than to have a broken mast over in your neighbor's yard. Drive a ground stake and connect it to the base of the tower with heavy copper wire for lightning protection. Since the antenna array will normally be about ten feet above the top of the tower, it is usually unnecessary to break up the guy wires with insulators. To bring the transmission line down the tower, weld regular stand-off insulators along one side. Do not tape the line directly to the metal.

A stub pole, which may be a 2x4 or 2x6 about twenty feet long, will be necessary to raise the tower without breaking it in the middle. Three persons can do the job easily. Use enough rope so that the vertical tower can be tied temporarily until the guy wires are fastened in place, and have two helpers hold ropes while the third person pulls the tower up with the aid of a rope and the stub. (See Fig 2.)

Drive a stake at the base of the tower to keep it from sliding back. Tie the tower to this stake with a rope

or piece of wire. Support the upper end of the tower on a step-ladder. Arrange a rope and pole as shown in the sketch, using additional ropes or wood braces to keep the pole upright so it will not swing over to one side. Have one helper walk up the ladder while the other two pull on the rope to get the tower started up. After it is up to about a 45 degree angle, one helper can finish pulling it up to a vertical position while the other two hold ropes to anchor the tower in place and keep it from going on over too far. It is a good plan to attach at least part of the guy wires while the tower is on the ground, but if all of them are attached they will not only be in the way but will probably get all tangled up. Some may prefer to use the guy wires in place of rope to raise the tower; however, the usual stranded guy wire gives so much trouble by kinking and getting tangled up that we prefer to use rope. Climbing the tower to remove the rope is not difficult, but some constructors may not like to climb, and in that case, the guy wires should be used to raise the tower, and all work must be done on the antenna array while the assembly is still on the ground.

-50-

C.G.A. BACK ON THE AIR

HEADED by B. W. Kniseley, '51, and advised by Commander P. V. Colmar, '29, the United States Coast Guard Academy's amateur radio station, WICGA, is back on the air after having been idle since early in 1941.

At the present time, the station is using the 20-, 40-, and 80-meter c.w. bands with proposed phone operation on the 20- and 75-meter phone bands.

Cadets are afforded the finest equipment with facilities for experimentation, construction, design, and other phases of radio at their disposal. The station provides a foundation for inter-

ests beyond the scope of academy routine.

From a technical, practical point of view, the organization is of unlimited value to the future Coast Guard officer. An ever-increasing proportion of the equipment he must be prepared to use and repair is electronic in nature, and the station affords an introduction and thorough understanding of the principles underlying much of this gear.

With these objectives in mind, it is hoped that WICGA can re-establish the cadets in the network of amateur radio.

-50-

Station WICGA (before the war, W1SET). On phone is Cadet Dave Howard, '51, formerly a merchant marine operator, while Cadet R. Brooks, '52, member of the Northeastern University Radio Club, in Boston, before becoming a cadet, stands by.



RADIO & TELEVISION NEWS

JULY SPECIALS SCR-522 EQUIPMENT

SCR-522 Transmitter-Receiver—Good used with tubes \$37.50
SCR-522 Transmitter-Receiver—NEW with tubes 49.50
PLUGS—SET FOR SCR-522—NEW 4.00
PE-94C—24 Volt Dynamotor—NEW \$4.95 USED 2.95
PE-98—12 Volt Dynamotor—NEW 25.00
BC-602—Control Box—NEW95
BC-631—Jack Box—NEW79
AN-104A—Antenna—NEW—Steel \$1.95 Copper 2.95
I-139A—TEST Set for SCR-522 5.00
IE-19A—TEST Set for SCR-522 200.00
Radio SET SCR-624C (SCR-522 Complete new ground station—packed in six boxes—operates from 110 V. A.C.) 485.00

I-82 Selsyn compass indicator 5" 360 degree dial \$2.45
Plug to fit either I-82 or I-8165
I-81 Selsyn compass indicator—NEW 3.25

HS-23 HEADSET—BRAND NEW 8,000 ohm with ear pads \$2.45
HS-33 HEADSET—With ear pads 1.29
HS-30 HEADSET—Complete with matching transformer, 6 ft. cord and PL-55 plug—NEW 1.95
HS-30 HEADSET—NEW95
DYNAMIC HEADSET AND MIKE—P.O. MARK II—NEW 1.95
P-16 HEADSET—NEW 1.50
HEADSET EXTENSION CORD—CD-307A—With PL-55 and JK-2649
Headset adapter MC-385D—High to low impedance—NEW35
T-17 Hand mike—NEW 1.50
T-32 Desk mike—NEW \$3.50—USED 1.95

IDEAL MOBILE POWER SUPPLY

PE-237—Heavy duty vibrator power supply, 6, 12, or 24 V. input. 525 V., 95 ma.; 105 V., 42 ma.; 6.5 V., 2 amp; 6 V., 500 ma.; 1.3 V., 450 ma.; small supply 100 V., 17 ma.; 1.35-450 ma. with tubes, shock mounted. BRAND NEW \$27.50
CD-501 Cable for PE-103—BC654—NEW \$ 1.95
RM-29 Remote control unit, ringer—NEW 7.95
SPEAKER—6" P.M. Compartment, 25 watts, 50-6,000 ohms. Waterproof—Excellent used 8.95
EE-8 Telephone Field Sets with hand set and ringer—Good used ea. \$9.00 dr. 16.00

Weston Electrical Tachometer meter Model 545 for use with MODEL 724 magneto. Speed 0-2,000 R.P.M. Ratio 2:1—Brand new \$17.50
Weston Tachometer Generator—Model 724, Type C—Good used 16.75

I.F. Transformer—1st, 2nd, or 3rd from SCR-522, 12,000 K.C. Iron core tuning, can be tuned to television I.F. frequency by removing padder cond. 35c each 3 for \$ 1.00
APN-1 Altimeter—New Complete 34.50
APN-1 Altimeter indicator—Basic movement 0-1 ma.—5 ma. shunt, 270° dial. An excellent basic movement for selecting your own meters—NEW 1.95
Meter Rectifier, full wave midget Selenium, 10 volts, 30 ma.—NEW29

BC-348 Mounting Base, Postpaid \$2.50
BC-348 Outlet plug, Postpaid80
BC-348 Mounting Base and Outlet plug 3.00

BC-357J—Beacon Receiver, 75 mc. tubes—NEW \$ 3.45
MN-26C—Bendix Radio Compass 150-1,500 K.C. tubes 17.50
BC-464—Target Receiver—5 channel remote, battery case, antenna, 68-73 MC—NEW 14.95
Interphone Amplifier—BC-709 Ideal for aircraft, booster for telephone system, etc.—NEW 4.50
Interphone Amplifier—CMX50128A, 12 V. 6 watts P.O.T.C.S. equipment—tubes and dynamotor—NEW 8.50
FL-8 Range Filter—NEW 1.50
Antenna Relay Unit—RE-2/ARC-5 Weston Ant. Current Indicator Meter, Relay, Vacuum Condenser, Excellent Condition 2.95
Handy—Talkie Crystal and Coil sets—3885 K.C. to 5,500 K.C. Specify frequency—2 crystals and 2 coils per set—NEW 2.25

Transformer—6200 V. @ 325 ma. secondary—Easily C.T. for 3100-0-3100 @ 650 ma. Primary 105/110/115 V. A.C. American Transformer Company—Instructions \$49.50
Transformer—2.5 V. @ 10 amps. C.T.—15,000 volt insulation—115 V. A.C. primary—Kenyon S-9883 5.95
Transformer—5 V. @ 190 amperes—115 V. 60 cycle input 12.95
Transformer—200-0-200 @ 50 ma.; 6.3 V. @ 3 amps. output 115 V. A.C. input—NEW 1.95
Transformer—100 watt Class B modulation P.O. BC375—NEW 2.95
Transformer—Peerless HQ-20 line matching 50/125/200/500 ohms—NEW 1.50
Choke—Smoothing 20 henries @ 300 mls.—15,000 V. insul. 115 V. A.C. primary—Kenyon S-9881 12.95

PHOTOCON SALES

1606-2 North Allen Avenue Pasadena 7, Calif.

TERMS: f.o.b. Pasadena, unless postpaid.
25% on all C.O.D. orders.
Californians add 2½% sales tax.

CAPACITORS

3x4 mfd.—600 V. D.C. Oil—Aerovox P05 \$1.49
.25 mfd.—20,000 V. D.C. Oil—G.E. 74F64 9.95
.035 mfd.—10,000 V. D.C. Oil—Aerovox R04 2.95
.02 mfd.—8,000 V. D.C. Oil—Aerovox M12 1.39
.01 mfd.—5,000 V. D.C. Oil—Aerovox M1269
.1 mfd.—3,000 V. D.C. Oil—Aerovox M12 7.99
.5 mfd.—2,500 V. D.C. Oil—Aerovox M1295
.25 mfd.—2,000 V. D.C. Oil—Aerovox 200949
10 mfd.—1,000 V. D.C. Oil—Sprague 2.45
Mica .005 mfd. @ 5,000 V. Sangamo Type G1 1.95
Mica .01 mfd. @ 5,000 V. CD-Type PL-154-40 2.95
Mica .015 mfd. @ 5,000 V. CD-Type 284A-695
Mica .00025 mfd. @ 5,000 V. CD-Type 364-669
Mica .0001 mfd. @ 5,000 V. CD-Type 321-669
Mica .005 mfd. @ 3,000 V. CD-Type 474-669
Mica .00025 mfd. @ 2,500 V. CD-Type 1053-6K50
Mica .015 mfd. @ 2,500 V. WE-D9695250
Mica .0005 mfd. @ 3,000 V. CD-Type T27-15H50
Mica .0002 mfd. @ 3,000 V. CD-Type 582-15L50

400 Cycle INVERTER—G.E.—5D21NH3A Input 27 V. 35 amps. Output 115 V. —485 V.A. single phase—NEW \$12.50
400 Cycle Inverter—G.E.—PE-218 Input 27 V., 100 amps. Output 115 V. 1,500 V.A. single phase—NEW 29.50
USED 17.50
800 Cycle Inverter—PE-206—NEW 5.95
800 Cycle Blower and Motor—1 ph. 6,700 R.P.M.—120 V. CAY-21773A. 1.50
24 V.D.C. Blower and Motor—4700 R.P.M.—1.35 amps—A.G. REDMOND CO. 1.95

TUBE SPECIALS

1A5 \$0.55	VR150 \$ 0.90	804TL \$ 0.89
5U4G55	E114890	721 2.00
6A489	VR127A 3.95	80185
6BB6 1.05	21 3.50	803 3.95
6HG60	2J22 9.50	807 1.25
6K7G60	2J26 9.50	815 2.25
6X8G90	2J27 9.50	837 1.50
6L6G90	2X275	849 39.50
6SN735	5BP1 1.95	891 Amperex 100.00
6SL7GT55	5BP4 2.50	NEW
6SN755	5CP1 2.50	95435
6X5GT59	5RKR2 1.05	95759
12A349	5RKR3 1.05	95845
12H635	719329	1616 1.00
12SH730	73T 2.50	162529
12SK740	21140	162939
12SR740	21140	1630 2.95
1E7G 1.25	316A 8.98	300445
3E2469	726A 7.50	6 Amp. 2.95
6X4 1.95	707B 9.50	Tungar.
WL530 1.75	249C 1.75	

Sound Powered Head and Chest Set—Made by Automatic Electric Com.—NEW, each \$ 5.95
Pr. 11.00
Reactor—5 Henries 284 ohms—.05 amp Westinghouse TYPE L59
Selenium Rectifier—24 V. @ 350 ma. I.T. & T. 4B3CM1 1.95



TRANSFORMERS

for Extracting Audio Specifications

ADC QUALITY PLUS SERIES For AM & FM Broadcasting and Highest Quality Music Reproduction

1. ± ½ db 30-15,000 CPS, all types.
2. Low transmission loss.
3. Excellent longitudinal balance.
4. Power ratings at 30 cycles.
5. Either top or bottom mounting.
6. Silver plated terminals.
7. High permeability mu metal shielding... extremely low hum pick-up.
8. Complete impregnation... to eliminate corrosion and leakage.
9. Highest grade insulation materials... withstand voltages far in excess of normal requirements.

ADC INDUSTRIAL SERIES For High Fidelity Music Reproduction

1. Dependable at lower cost.
2. Response guaranteed ± 1½ db from 50 to 10,000 CPS.
3. Minimum insertion loss.
4. Power ratings at 50 cycles.
5. Same construction, insulation and impregnation as Quality Plus series.

Tolerances of ± ½ db in transformer response from 30 to 15,000 CPS with low transmission loss and low harmonic distortion are guaranteed in the ADC "Quality Plus" series of transformers.

Over the range 50-10,000 CPS the Industrial series guarantees tolerances within ± 1½ db. Thus a record of dependability uncommon in production transformers is provided for electronics engineers to serve for FM-AM Broadcasting, for high fidelity music reproduction, for video work and other electronics requirements.

TRANSFORMERS: Impedance Matching—Bridging—Filament—Input-Output—Filters—Plate Supply—Smoothing Chokes—Swinging Chokes.

COMPONENTS: Jacks—Jack Panels—Plugs—Patch Cords—Sound Effect Filters (Frequency cut-off adjustable from either end).

Write For Catalog today—complete details on available products. For Research laboratory, and product design, special specifications engineered and quoted. We invite your inquiry.



Audio DEVELOPMENT CO.
2845 13th Avenue South • Minneapolis 7, Minnesota
Cable Address: AUDEVCO

Audio Develops the Finest

NOW!

only

JERROLD TV-FM BOOSTER

**Comes Equipped With
AMAZING, NEW**

MATCH-A-TRAN

INCLUDED AT NO INCREASE IN PRICE

The Jerrold TV-FM Booster, and only the Jerrold Booster—is now equipped with the amazing new built-in Match-A-Tran. A new, variable step-impedance transformer that helps provide a perfect match between Booster output and any television receiver for all channels. It is exceptionally efficient on the high channels.



IMPROVES DISTANCE RECEPTION

Here, at last, is the secret of good television reception and more TV sales over a wider fringe area. The Jerrold TV-FM Booster with Match-A-Tran puts more gain into the receiver than any other booster. This means better definition, greater stability and a much longer distance reception for any television receiver. It means clearer, brighter, sharper pictures for distant areas.

You can see the Jerrold Booster with Match-A-Tran at your radio wholesaler or parts-jobber. Or write us for information

\$37⁵⁰
List

JERROLD ELECTRONICS CORP.
121 N. BROAD ST. PHILA. 7, PA.

TV Antenna (Continued from page 58)

quired screws are being tightened.

All of the components are required to withstand the ice loads and wind loads which, of course, vary considerably in the several areas of the country. Various surveys made in connection with electric power distribution indicate that at least a one-half-inch ice load should be considered minimum. The calculations involving this ice load are comparatively simple, as some parts can be considered as uniformly loaded cantilever beams and other parts as cantilever beams having a uniform load, also a concentrated load, at certain locations. The physical test can be very closely approximated by adding the correct amount of weight every 1" or 2" along the various elements.

In the above, it will be noted that the ice load was named prior to the wind load. This is a logical sequence since the wind load should be calculated on the antenna with the ice load in place. This is necessary because of the increased projected area subjected to the wind by the ice loaded members. These calculations have proven that the turning moment or torque of an antenna bay relative to the mast is surprisingly high.

Therefore, the hardware and brackets mounting the crossarm to the vertical mast must be capable of exerting very high locking pressures. In working with the various non-ferrous materials in the mast, it was found that the required locking pressures could not be obtained because such mast material would swage down or reduce in diameter as the brackets were tightened. Vibration tests also proved that the material continued to "flow," and in a comparatively short length of time the right angle connection of the crossarm and mast was found to be loose and unable to withstand the turning moment of the above referred wind loads. Due to this, the requirements of this joint dictated the use of a steel tube and a plug inside of the tube to make a completely solid joint. In addition, the bolts are passed directly through both tubular members to eliminate any possibility of the bay's slipping around the mast and losing its orientation. The mechanical attachment of the straight dipole, folded dipole, and reflectors on the low-band units to crossarm or mast are accomplished in a similar manner.

This type of joint was found unnecessary on the high-band units where the projected area subjected to the wind is not as great and the lever arms involved in the turning moment are comparably smaller.

The above referred plugs in the ends of the low-band crossarm and in the upper end of the mast also eliminate the "pipe organ" effect which these tubular members may otherwise have in certain wind velocities and directions. This howling sound is very

readily transmitted into and through the house structure and can prove very annoying. Closures, for similar reasons, are also placed in the ends of the antenna elements themselves.

The 1 1/4" O.D. steel tubing used in the mast and low-band crossarm was likewise found to satisfy other important considerations. The torsional twist of the cross-arm must be held to a minimum since a torsional vibration set up in this member will cause the antenna element on one end and the reflector on the other end to mechanically vibrate out-of-phase. If this torsional vibration of the cross-arm, amplified through the length of the reflector and the dipole, swings the tips of these two elements excessively relative to one another, the picture on the CR tube will definitely be modulated. The results of a series of tests indicated that with the use of steel tubing in the crossarm, 1 1/4" O.D. was required to eliminate this picture modulation. The use of various non-ferrous materials, which have a lower Young's modulus and less torsional rigidity, would require considerably larger diameters if this picture modulation is to be controlled.

Since mechanical design can be finally proven only by actual mechanical tests, a number of the units were made in the laboratory prior to final tool release. However, to simulate the final design as closely as possible, temporary single cavity molds and temporary dies were actually made in the lab, and parts were produced, using the same materials and processes that would be involved in the production quantities. Only in this manner could the entire over-all design be completely checked in every respect before the production tools were made.

As explained above, the element

Fig. 8. Field pattern of Ward Model TVHA-9.

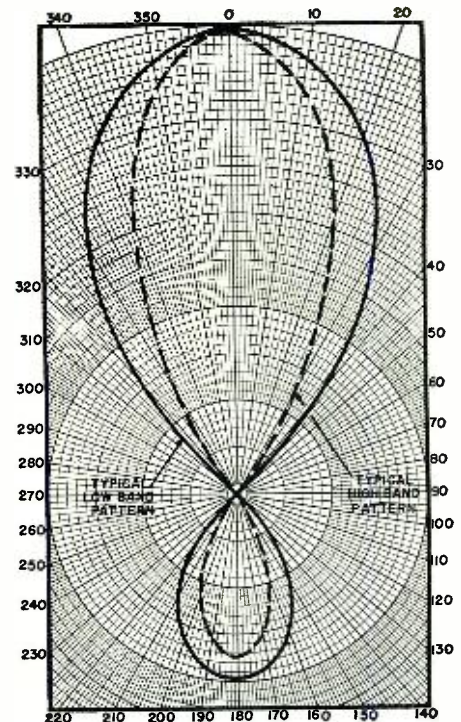

TV TUNER.....\$5.95



Here is a precision front-end made by well-known mfr. Covers all 13 TV channels with 8 permeability-tuned coils; coarse & fine tuning; IF freq. 21.25 Mc; uses 6AG5 RF, 6AG5 mixer & 6C4 oscillator; completely wired but not tested; with diagram, less tubes, IF coil & trimmer cond. Some may need minor repairs, but satisfaction guaranteed. An outstanding value—compares with any \$27 tuner. Hurry for this bargain. 3% x 2 3/4 x 7; shipping wt. 4 lb. ONLY.....\$5.95
In lots of 10, \$5.25; In lots of 100 4.00

BEAM ROTATOR, reversible 4.5 RPM motor for 2, 6 or 10 meter antennas; operates from 24vDC or 24 to 36vAC at 2 amps; torque 70 lb./in. Easy mounting. 7 1/2" lg x 2 1/4" dia; shaft 3/8" d x 1 1/2" lg; shipping wt. 6 lb.\$7.95

HANDSETS: TS-9 low impd. for EE-8 field phone & general telephone use; has butterfly switch & 3 leads w/spade plugs. N-1, \$4.95; U-1.....\$3.95

TS-13 hi-impd. for BC-659, BC-620, etc. W/switch & plugs PL-55 & PL-68. N-1, \$5.95; U-1.....\$3.95

TS-10 sound-powered; no batteries req. Just connect 2 or more & start talking. N-1, \$19.95/pair; ea.\$10.95
U-1, \$16.95/pair; ea. 8.95

EARPHONES, Air-Corps type HS-33, 600 ohm impd; U-1.....\$1.50

HS-30 hearing-aid type, 300 ohm impd; N-1.....\$1.00

COLLINS VFO DIAL.

5 calibrated "ham" bands from 3.2 Mc to 32 Mc; complete with pointer, gears, logging dial & flywheel; scale 6" dia. A bargain at only.....\$1.00
Ten for 8.50



NATIONAL VELVET

VERNIER, type N, 4" dia. with decimal vernier; planetary drive 5:1; scale 10 to 0; Regular net \$4.50.

OUR PRICE.....\$2.50

CRYSTAL DIODE IN27, in protective lead case.....\$1.00

WIRE RECORDER MECHANISM with recording & playback head & 78 RPM turntable; same as used in most wire recorders. Records up to 1 hr. radio program, voice or direct from own phono turntable; has place to mount standard phono pickup. Furnished with osc. coil & Diag. of 3-tube amplifier to adapt unit to any radio or amplifier. 9 x 13 x 3 1/4; 15 lb.\$22.95

AUTOMATIC CHANGER, Seeburg 2-post changer with xtal pickup. 10" or 12" records. Quantity limited.....\$14.95

PHONO TURNTABLE, Eastern S-3 rim-drive 78 RPM, 9 1/2" table.....\$1.89

SCHEMATIC DIAGRAMS: BC453A; BC-456 & BC457, BC458 or BC459; ART13; SCR269G (BC433 compass); SCR522; RT7/APN-1; RA 34; BC611 Handie-Talkie; Navy "Walkie-Talkie" MAB; BC-659; BC620; BC603 or BC683; BC604 or BC-684; RT19/ARC4; BC728 Handie-Talkie; BC375; BC1335; Army Super-Pro BC799, BC794 & BC1004 (on 1 sheet); BC-923; RA-120. Each.....\$0.65

AUTO AERIALS, Radiart 363A1, 63" 3 sect. Per dz.\$20.00
EACH..... 1.95

Radiart CF392, 92" 3 sect. Per dz. 27.00
EACH..... 2.45

ICA 4553, 96" 3 sect. Reg. net \$3.57. OUR PRICE..... 2.45

Radelco FM3 concealed fender mt; 54" 3 sect. 2.95

Radelco FM4 concealed fender mt; 72" 4 sect. 3.50

FREE SCREWDRIVER WITH \$10.00 ORDER OR MORE

N-1: unused, excellent; U-1: used, excellent. Postage extra. Minimum order \$2.00.

TERMS: Net Cash, 25% deposit on C.O.D.'s

ELECTRONIC SUPPLIES

219-R East 1st St. Tulsa 3, Oklahoma

the results of the first tests using the sweep oscillators. The sweep oscillator method has a big advantage in that it is capable of showing impedance matching characteristics over a broad portion of the spectrum at one time when displayed on the oscilloscope.

The above discussion has centered around only two of the several models which are required for a complete line of television antennas. Fig. 3C shows

a stacked array which incorporates all of the various problems outlined with several additional variables. Fig. 7 shows response curves, and Fig. 6 shows typical field patterns for such a unit. These three types of antennas are typical examples and show the procedures necessary to be carried out if a full knowledge of the capabilities of the antenna, electrically and mechanically, are to be known with accuracy. -30-

CORONA AND HIGH-VOLTAGE ARCING IN TELEVISION RECEIVERS

By MATTHEW MANDL

CORONA or arcing in television receivers usually results when high-voltage leads are brought too close to chassis or other ground points. Sharp bends in the wire carrying the high-voltage currents will also cause corona effect, and all such wires should be well-spaced from other wires or metal components. The high-voltage leads should also be supported well away from chassis and the outer coating of the tube by a thin wire with a polystyrene terminal through which the cable runs. A thin section of fibre or plexiglass can also be used and makes a good insulator.

Both corona and arcing may be best found while the set is turned on, so that their visible effects may be observed. Extreme caution must be exercised, however, for the potentials involved are high, and severe shock may result from contact. This is particularly true when the corona or arcing is within the power supply housing, and no probing should be attempted except with a long, well-insulated rod. Never use a screwdriver or other metal object.

One place where corona sometimes occurs and is often overlooked is that section of the tube where the high-voltage lead plugs in. During rainy weather, or if the receiver is in a home with a high moisture content, corona occurs across the radius of the bare section of the picture tube in which the high-voltage lead is plugged. The outer aquadag coating, which is at ground potential, is not applied to this section so that no short can occur. Moisture, however, condensing across

this area will result in corona until the set has been on for several minutes. When the warmth from the tubes dries out the moisture, the corona effect stops.

The illustration shows this section of the tube in the RCA 8T241 TV receiver. Note the insulated ring through which the high-voltage lead runs. This ring acts as a stand-off insulator and is supported by a thin, stiff wire running to the yoke assembly mount.

When corona occurs, this bare surface area should be wiped clean and dry with a cloth so that not only the moisture is removed, but the dust as well, for the latter absorbs moisture and makes this area more prone to corona. Any smudges or smears should be removed with a cloth which has been dipped in carbon tetrachloride; then the surface wiped again with a dry cloth.

In sections of the country where humidity is unusually high, corona effect can also be minimized by giving the picture tube a slight rotation to bring the bare circular area closer to tubes which generate heat. For the set in the illustration, this would mean a quarter turn to the left, bringing the area nearer the two tubes shown. These tubes (6SN7 and 6K6) are the normal size receiving type and would produce heat more quickly than the tubes on the right, which are the miniature type in the r.f. section of the receiver. This shortens the warm-up period of the high-voltage section of the picture tube and aids in keeping it dry. -30-

To prevent arcing, keep high-voltage lead away from all metal parts.

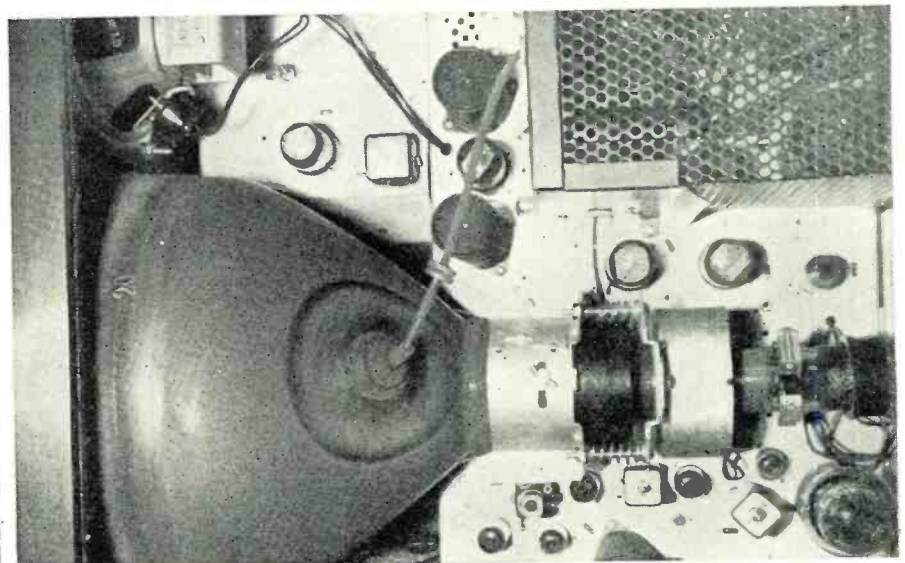

Television Receivers

(Continued from page 39)

arity of the discriminator transformer and the 4.5 mc. pick-off coil. Be sure to use as small a signal as possible when aligning the 4.5 mc. amplifier and the succeeding FM detector circuit, since strong signals cause the tubes to load down the tuning coils, altering their response characteristics. In this respect, one large manufacturer whose sets were suffering from the 60-cycle buzz found that the ratio detector transformer needed replacement because of its poor balance. Therefore, carefully check both halves of the detector response curve to see that they are sufficiently linear.

Finally, an incorrect setting of the local oscillator frequency, if sufficiently far removed from its proper frequency, will also produce the buzz. What happens here is the shifting of the sound carrier along the i.f. response curve to a point where it receives more amplification than it should with this system. The setting of the oscillator frequency becomes increasingly critical as the amplification accorded the sound carrier in the i.f. system increases. Thus, in the *Motorola* receiver previously analyzed, the level of the sound carrier was only 15.6 db. below that of the video carrier, whereas a better value would have been 26 db. It is to be expected, therefore, that the setting of

the oscillator frequency will be more critical in the *Motorola* set than in another receiver which provides for a greater db. difference between the two carriers in the i.f. system. It is interesting to note that while the first *Motorola* models did not contain a fine-tuning control, the more recent models do.

It is not always true that the appearance of the 60-cycle buzz indicates that the receiver is at fault. As indicated earlier, the station may be the offender. When there is more than one station locally, switching to these other stations will soon indicate where the difficulty lies. If the buzzing is evident with every station, it is safe to assume that the set is at fault. On the other hand, if the buzz is present only for one station, then the receiver is operating normally and the trouble arises at the transmitter. When a community is served by only one station, the best method is to observe whether other Inter-carrier receivers exhibit the buzz. It is a good practice to have a monitor receiver on at all times, one which is kept in top operating condition. This will serve as a standard against which sets brought into the shop can be compared.

One more word before leaving Inter-carrier TV. From all indications, the number of manufacturers using this system is increasing, and it would not be surprising to find them in the majority in a year or two.

(To be continued)

K2USA—A U. S. ARMY AMATEUR STATION

AS might be expected in view of its mission, the Signal School of the United States Army, located at Fort Monmouth, N. J., boasts of one of the largest and most elaborate ham stations in the country. Formerly licensed as W2OEC and W2MON, it was recently assigned the appropriate call, K2USA. Under the supervision of M/Sgt. Frank T. Hass, it is very active in the MARS nets.

Separate transmitters and antennas are used for 20-, 40- and 80-meter c.w., with power running from 400 to 1000

watts. One BC-610 (the military version of the *Hallcrafters* HT-4) is kept on 10-meter phone and another is used for either 20- or 75-meter phone. Name any receiver and you'll find it in the place.

K2USA is open almost around the clock to all military personnel with ham tickets and is well patronized. A typical group is likely to include colonels and corporals, and occasionally a general looks in. Altogether, the maintenance of the place is a full-time job for Master Sergeant Hass . . . R.H.

M/Sgt. Frank T. Hass, at left, operates the U. S. Army Amateur Station, K2USA.

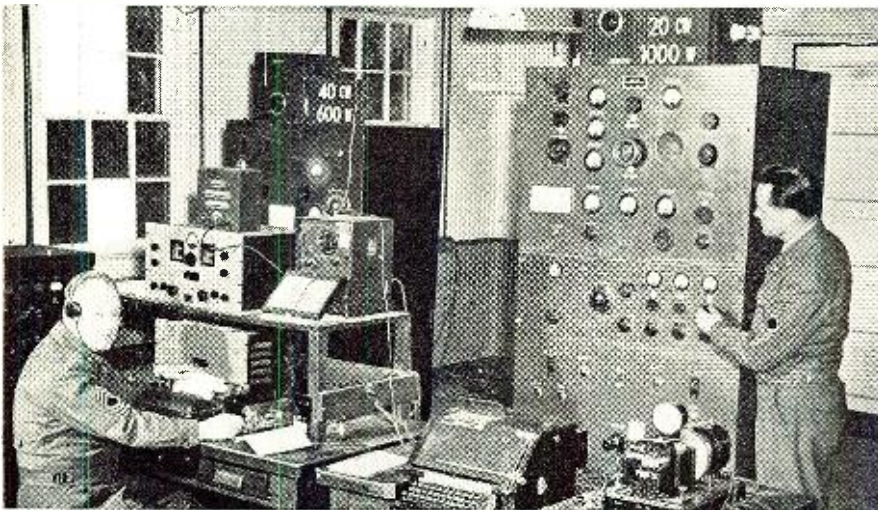

July, 1949

NEW TELEKITS

NOW **59⁵⁰**

Jobbers: Write for Information

NEW
TELEKITS
10-B \$82.99
7-B \$59.50

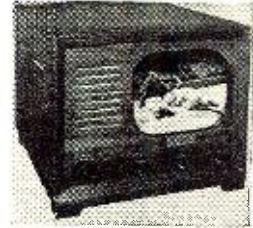

Sparkling new Telekit 10-B has 52-inch screen; Brand new compact lay-out has video tube mounted on chassis. Big illustrated easy-to-follow instruction book guides you step by step through easy assembly. No special knowledge of television is required. All you need is a soldering iron, pliers, and screw driver. Telekit 10-B, \$82.99. Tube kit, including 10BP4 and all other tubes, \$55.80. 10-B Telekit cabinet \$24.50. Telekit Guarantee includes free factory service.

Write for catalog listing 10-B and 7-B Telekits. New 7-B Telekit for 7-inch tube, \$59.50. Tube kit, including 7JP4, \$41.58. 7-B cabinet, \$24.50.

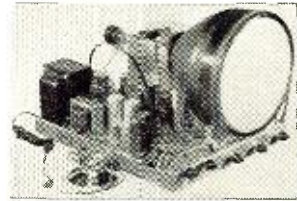

Note simple clean lay-out for easy assembly of new Telekit 10-B. Features 2 sound I. F. stages, a new pre-built, pre-aligned tuner that includes a stage of R. F. for distance reception. Easy-to-adjust horizontal lock circuits. Beautiful new model cabinets for 7-B and 10-B are heavily constructed of hand rubbed walnut.

13
CHANNEL
TUNER
\$19.95



NEW 13 CHANNEL TUNER is a small compact unit with stage of R.F. Made to conform with Telekit or any other TV set having video I.F. of 25.75 Mc. Complete with tubes, pre-wired, pre-aligned; only three connections to make. See your jobber, or write to us for information. Your cost, \$19.95.

Write for catalog of Telekit antennas, boosters, television kits, tuners, television parts and tubes.

TELEKIT

ELECTRO-TECHNICAL INDUSTRIES
1432 NORTH BROAD STREET PHILADELPHIA 7, PA.

NEW TV RECEIVERS on the Market

TABLE MODEL TV RECEIVERS

The two new table model television receivers, 610 and 612, announced by the *Hoffman Radio Corp.*, Los Angeles, Calif., feature channelized station selectors, picture synchronizers, volume control, and a new automatic gain control that stabilizes picture contrast.

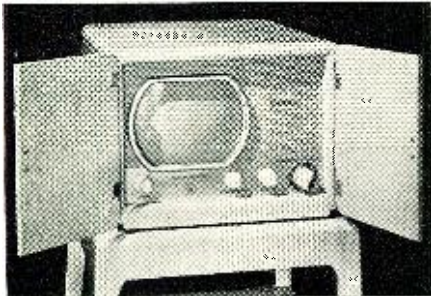

Other features incorporated in each of these two models are the *Hoffman* "Easy Vision" lens, an acoustically engineered Alnico PM speaker, and easily serviced and rigid tube mounting for stable performance. Twenty tubes (many dual purpose) in each, plus rectifier and picture tubes, produce reception comparable to larger sets.

Both models are available with matching stands and are available in a choice of two beautifully designed cabinets, combed grain blonde oak, with modern hardware and matching doors, or mahogany, with traditional hardware. The 610 is 18 $\frac{3}{4}$ inches wide, 14 $\frac{1}{4}$ inches high, and 20 $\frac{1}{4}$ inches deep, while the 612 is 20 $\frac{1}{2}$ inches wide, 16 $\frac{1}{2}$ inches high, and 21 $\frac{13}{16}$ inches deep.

TELE KING "GRAMERCY"

A remarkably compact ten-inch table model is Model T-410, the "Gramercy," produced by the *Tele King Corporation*, 601 W. 26th St., New York, N. Y.

It has a full 52 square inch "Tele-



ramic" picture, which helps to insure perfect definition and resolution of vision and sound. The cabinets are either walnut or mahogany, with contrasting swirl grain panelling, and

being only 15 $\frac{1}{4}$ inches high, 21 $\frac{1}{2}$ inches wide and 19 $\frac{1}{4}$ inches deep, are easily moved from room to room.

16-INCH TV CONSOLETTA

United States Television Mfg. Corp., 3 West 61st St., New York 23, N. Y., has produced its first 16-inch television consolette, containing FM high-fidelity radio, as well as large-screen television.

The third consolette offered by *UST*, the company having previously introduced a 12-inch and a 15-inch consolette, it incorporates all the TV reception refinements offered in these other popular sets. It contains 26 tubes, including 3 rectifiers in addition to the 16-inch cathode ray tube, and has an all-channel tuner and automatic synchronizing control that assures picture stability.

With the introduction of this latest



receiver, the *UST* line now is one of the most extensive in television, ranging from ten-inch table models to commercial units that throw pictures as large as 12 by 16 feet on a remote screen.

INSTITUTIONAL TELEVISION

Telecoin Corporation, 12 East 44th St., New York 17, N. Y., has introduced Tele-Video, a four-unit installation hooked together by cables, which is adaptable for projection on screens up to 63 square feet (7 by 9 feet).

This reflection-projector institutional system presents life-size pictures, and its flexibility of installation makes it readily adaptable to a wide range in shape and size of rooms. It uses an optical principle in which the picture is thrown on a 14-inch parabolic mirror and projected through a specially designed picture corrector on the screen a few feet distant.

The four major components are a master remote control unit providing

all-channel tuning, a remote driver unit, audio amplifier, and optical barrel, besides 49 electronic vacuum tubes, more than double the number used in the average home television receiver. These four major components are mounted on an individual chassis of blue-green Hammeroid finished steel with chrome trim.

TRANS-VUE ENTERTAINER

Trans-Vue Corp., 1139-41 S. Wabash Ave., Chicago 5, Ill., has announced the distribution of a remote control television unit designed for use in commercial locations.

Multiple remote television viewing units can be placed separately in any part of the room or rooms and be controlled from the one conveniently placed "master tuner." Patrons in any part of the room can hear properly as well as see the program, because there is equal tone distribution.

As many as ten remote television viewing units can be accommodated by the tuner unit, and all of the viewing screens are equipped with a new feature called the "Polaroid filter." This one-way filter has been designed to eliminate fluorescent, incandescent, and daylight glare, giving the sharpest, clearest picture possible, preventing "television eyes."

For best viewing at any angle the remote unit design provides 8-degree angle compensation. The cabinet size is 23 inches high, 22 $\frac{1}{2}$ inches wide, and 28 $\frac{3}{4}$ inches deep.

T-69 TV CHASSIS

The Hallicrafters Company, 4401 West Fifth Avenue, Chicago 24, Illinois, is showing a 15-inch TV chassis designed for custom installation. The unit needs only a cabinet or mounting space in the wall.

The T-69 was especially manufactured for big-picture tube operation and gives a 130 square inch picture on the 15-inch, direct-view tube. Component units are mounted on a rein-

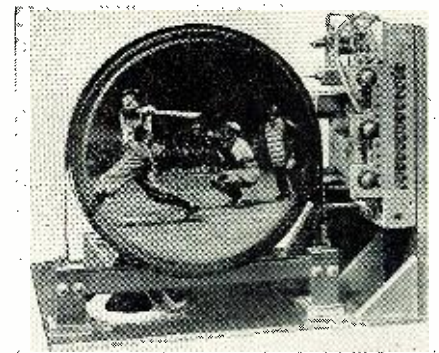

forced wood frame to make one complete structure that can be slipped into a cabinet or opening in wall, bookshelves, etc. Over-all size is 19 $\frac{1}{2}$ by 23 by 21 $\frac{1}{4}$ inches.

Included also is an 8-inch PM speaker and 300-ohm twin-lead for any standard antenna. The receiver chassis, speaker, picture tube, and rectifier chassis are connected with plug and socket connectors so the relative

NEW *Rauland* High-Fidelity 1825 Phono Amplifier TOPS FOR CUSTOM INSTALLATIONS

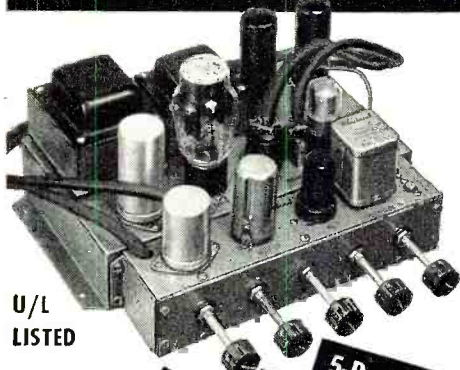

U/L
LISTED

EXCLUSIVE!
Detachable
Remote
Preamplifier

Preamplifier is detachable; mounts in any position to meet mechanical requirements of any custom installation. Compact; only 2 3/8 x 2 3/8 x 1 1/2". Unlimited flexibility for custom-built installations.

- 5-Position Frequency Cut-Off
 - Boost Type Tone Controls
 - Dual Volume Controls
 - Dual Input Selector
 - Plug-In Equalizer
- ± 1 DB, 40 TO 20,000 CPS
25 WATTS OUTPUT (5% harmonic distortion)

AVAILABLE AT YOUR REGULAR SUPPLIER, OR WRITE FOR DETAILS

Electroneering is our business

SOUND EQUIPMENT *Rauland* **INTER-COMMUNICATION**

RAULAND-BORG CORPORATION • 3523-G ADDISON ST., CHICAGO 18, ILL.

YOU'LL HIT THE JACK- POT



with QUAM Adjust-a-Cone SPEAKERS

There's a jackpot of satisfied customers waiting for the serviceman who uses Quam Adjust-a-Cone Speakers. Here's why!

First, there's the unsurpassed performance and efficiency of Quam Adjust-a-Cone Speakers. They will make any receiver sound as good or better than it did with the original equipment.

Second, you can be sure of trouble-free service. With the construction of the Quam Adjust-a-Cone Speaker, because it permits accurate centering of the voice coil after assembly, a rubbing voice coil is practically unheard of.

Third, By replacing a defective speaker with a Quam Adjust-a-Cone, the serviceman makes a larger margin of profit, ensures a satisfactory job and a satisfied customer.

You can hit the jackpot with Quam Speakers.



MAIL THIS
COUPON FOR
FREE CATALOG

QUAM-NICHOLS CO.
522 E. 33rd Place
Chicago 16, Illinois
Please send QUAM Catalog.

Name

Address

City State

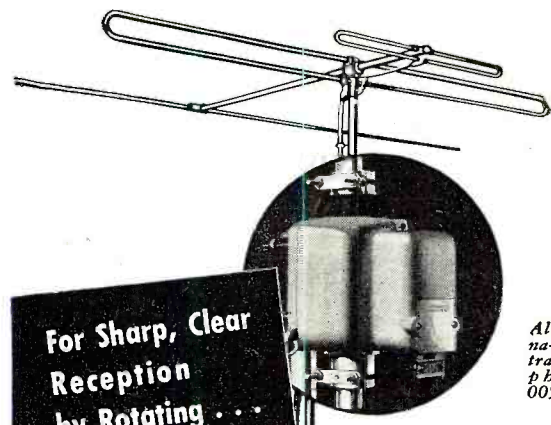

For Sharp, Clear
Reception
by Rotating . . .

Alliance Tenna-Rotor illustrated with Ampheno 114-005 antenna.

AMPHENOL ANTENNAS GIVE HIGHEST GAIN!

AMPHENOL

Where TV broadcasting stations are at wide angles from point of reception and re-orientation of the antenna is required to maximize each station, Amphenol television antennas provide the greatest gain by virtue of the in-line high and low band folded dipoles which beam in a clean, narrow directional pattern. The high front-to-side and front-to-back ratios not only provide maximum signal pickup in the exact desired direction, but also secure against any interference from an unwanted direction.

Durable, sturdy, aluminum construction withstands high wind and ice loading combined.

Install Amphenol in single bay or stacked array.

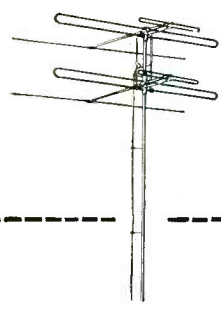

Illustrated at left is the standard Amphenol television antenna shown in stacked array (Model 114-302) for added db gain in fringe areas . . . or each bay may be individually oriented.

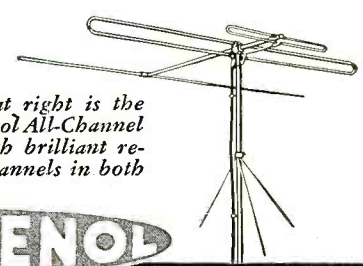

Model 114-005 at right is the standard Amphenol All-Channel TV Antenna with brilliant reception on all channels in both bands.

AMPHENOL

AMERICAN PHENOLIC CORPORATION
1830 SO. 54TH AVENUE • CHICAGO 50, ILLINOIS

HARVEY HAS THE TOPS

TECHMASTER SUPER-16 KIT



31-tube kit with components for use with up to 20-inch tube. Don't confuse with cheaper kits. Pre-wired and aligned RCA front end, all major parts mounted, adjustable line mounting brackets. Complete manual with service notes, all RCA. Ultra-simplified wiring instructions. Wire it over a week-end. Complete less line tube..... **\$184.00**
16" kine (sold separately)..... **\$63.50**

FM TRANSLATOR General Electric Model XFM-1



Post-war version of the old G.E. J.F.M-90 Translator which was used and enjoyed by tens of thousands of discriminating radio listeners.

Covers 88-108 mc range, dial 12 inches long, uses guillotine tuning for highest efficiency, high stability. Designed for export, has power inputs for 110 to 250 volts, 50/60 cy. In attractive natural walnut cabinet—10 3/4" high x 15 3/4" wide x 11 3/8" deep, complete with 8 tubes. Tropic-proof construction. Quantity limited.

Special Price **\$49.50**

WESTERN ELECTRIC SPEAKERS

New low prices on these superb speakers

728-B—12-inch speaker, handles 30 watts power, uniform frequency 60 to 8,000 cycles, 10 db down at 10,000. Level at 30 feet on axis, 93.5 db at 30 watts..... **\$52.00**

755-A—8-inch speaker, smaller version of 728-B; 8 watts, 81.5 db, 70 to 13,000 cycles.... **\$29.15**

757-A—Two-unit woofer and tweeter combination in enclosure. Built-in cross-over net, work, 30 watts power, 60 to 15,000 cycles.... **\$364.00**

NOTE: All prices are Net, F.O.B. N.Y.C. and are subject to change without notice.

Telephone:  Luxembourg 2-1500

HARVEY

RADIO COMPANY INC.

103 West 43rd St., New York 18, N. Y.

positions can be altered if desired. A particular feature is all-channel push-button tuning, providing instant station selection on any of the twelve tuning channels.

ALL PURPOSE CHASSIS

Sightmaster Corporation recently introduced its all-purpose television chassis at its showroom, 20 East 35th St., New York City.

Named the "Sightmaster 50," this chassis is the first in which any size television tube, 10 to 20 inches, can be used and is the culmination of eight months of intensive engineering and field testing. Twenty-seven tubes, including the viewing tube, are incorporated in it.

The design of the chassis permits the use of smaller cabinets, which makes for greater beauty, and either a remote control unit or conventional controls can be utilized. Having been built from a quality point of view, embodying new improvements and refinements, it sets a high standard in TV engineering and design.

—30—

New TV Screen

(Continued from page 37)

has no tendency to lighten grays or blacks. (See Fig. 2.)

The result is a screen in which the contrast is appreciably greater than that obtainable with ordinary cathode-ray tubes, allowing the various portions of the image to achieve their proper shading and therefore not requiring excessive illumination in order to obtain fidelity and contrast. So marked is this effect, when viewed for a few minutes by the average person, that the result is the ability to look at the screen throughout a typical period of entertainment without any of the fatigue associated with ordinary TV viewing. In tests conducted with layman observers, it was conclusively shown that when viewing the new tube, these observers set the contrast control, on the average, to approximately one-half the setting that was employed when using the conventional cathode-ray tube.

Further desirable effects can be obtained by the use of metal such as zirconium in the screen. This is a poor secondary emitter, opaque to light and yet a good gas getter, which, under the influence of bombardment, picks up gas occluded in the rest of the cathode-ray tube. The combination of a getter within the screen powder and a light absorber is one of the features of this process. As a matter of fact, a highly reflective substance, such as silver, which could be opaque to light and yet reflect internally the light from the luminescent crystal, would be highly desirable. It might actually improve the light and, at the same time, discourage dispersion if the rear side thereof were covered with a dark substance, or the silver oxidized. This is done to

discourage reflection, but the crystal is left exposed, however, to the rear.

Development of this screen was done by Warren G. Taylor, E. Browning, and the author, all working under the direction of Dr. Lee DeForest, Director of Research of American Television, Inc.

—30—

International Short-Wave

(Continued from page 45)

Servicio Radiofonico Internacional (S.R.I.), and stations used are LRU, 15.29, *Radio El Mundo*; LRS, 11.88, *Radio Splendide*, and LRY, 9.445, *Radio Belgrano*.

Schedule was given as Spanish, LRU, 1600-2100 and LRY, 1545-1645; *English*, LRS, 1731-2030; French, LRS, 1600-1730; Italian, LRY, 1515-1745; Portuguese, LRS, 0600-0800, 1000-1300, 2030-2230. However, these schedules seem to fluctuate from day to day. LRU, 15.29, appears to have *English* around 2100-0100 daily, while LRY, 9.455, seems to have its evening program around 2130-0100. Usually, news is given around or on the hour. Programs begin and end with announcements in Spanish and in the language of the transmission; programs consist of the "news bulletin of the S.R.I.," with Argentinian and some international news; musical programs (both popular and classical), and some specialized commentaries on sports, movies, and so on.

Reports are requested to *Servicio Radiofonico Internacional*, in care of the station heard, Buenos Aires, Argentina.

* * *

Mexico City Conference

The High Frequency Broadcasting Conference of Mexico City concluded after nearly six months of work. Some countries signed the agreement relating to the frequency allocation plan prepared by the conference. Eighteen countries (including the U.S.A. and the U.S.S.R.) did not sign it. The U.S.A. delegation was not able to agree to the plan since it considered that it is technically unsound in some aspects, due to the inclusion of more broadcasting hours than can be accommodated without severe interference between stations operating on the same channel, that the division of frequency time among the countries is not equitable, and that deliberate jamming of U.S. broadcasts is now being carried out by stations which direction finders indicate are located in the U.S.S.R. The assignment plan agreed upon is for one season and sunspot number index. A technical planning committee was to meet on June 15 in France to work out six additional plans for other seasons and sunspot numbers. Later in the year another High Frequency Broadcasting Conference will be held in Italy to consider the plans prepared by the technical planning committee. (This report comes from Roger Legge, New York, who attended the Confer-

ence, and it appeared in *Universalite*, house organ of the Universal Radio DX Club.—KRB)

DX Notes

Summer schedules of "Sweden Calling DX-ers" is Saturdays 0215, 6.065, 15.155; 1015, 10.780, 15.155, and 2015, 10.780, 15.155.

For the summer, the weekly DX program from *Radio Australia* is scheduled for Sundays beginning 0843 in the East Coast beam over VLB, 9.54, VLC7, 11.81. Schedules for the DX session in other beams remain the same.

From Russell Henderson, Swiss Short-wave Service, comes this letter:

"We should like to thank you sincerely for your fine collaboration in our recent contest which we broadcast for all-comers in honor of the International Short-wave Club (London). The reception reports, all of them, which we received in answer to our competition, have not only been a heart-warming indication of the collaboration of our DX friends, but also a very valuable indication of reception of our short-wave stations in all parts of the world. Reports came from places as far apart as Canada and Korea, and from youngsters of twelve and old-timers nearly in their seventies, from doctors in England and soldiers on Malta, from students in Sweden, and from radio engineers in Australia.

"The winner of the first prize in the *ISWC* section was Reginald H. Greenland, 39, Kensington Road, Barnsley, Yorkshire, England, who will receive a Swiss music-box, as will the winner of the all-comers' section, George A. E. Major, Roselyn, Somerville Street, Manjimup, Western Australia (George is an *ISW* Dept. monitor.—KRB). The ten runners-up in both sections will receive illustrated books on Switzerland, and a further fifty DX entrants will receive illustrated books on Switzerland."

Mr. Henderson listed that "a second prize went to Jack E. Gardner, Jacksonville, Florida, and runners-up prizes were sent to R. O. Lyttle, North Bay, Ontario, Canada; Glenn Richards, Sheboygan, Wisconsin; August Balbi, Los Angeles, California, and Gustave Magnusson, Providence, Rhode Island." (Most of these winners are *ISW* Dept. monitors.—KRB.)

Radio Club Notes

Belgium—Leopoldville recently announced that the Belgian Amateur Union is interested in contacting listeners throughout the world; QRA was given as Belgian Amateur Union, ONL 193, P.O. Box 643, Brussels, Belgium. (Barnes, N.Y.)

U.S.A.—Newly-elected officers of the Newark News Radio Club, 215 Market Street, Newark, New Jersey, include Irving R. Potts, president; Peter J. McKenna, executive secretary; Benjamin Feinstein, assistant executive secretary; and Walter L. Townley, treasurer. Several ties existed in the

BEST BUYS—KITS—PARTS—ACCESSORIES **LOWEST PRICES**



REAL BARGAIN!

HS-16 Headphones with standard long cord (6 ft.) and adjustable headband. Unquestionably the best buy in surplus phones ever sold. Tested before shipping. Limited quantity. \$1.35 ea. POSTPAID in U.S.A. and Canada.



POWER SUPPLY FOR ANY 274-N RECEIVER

Here it is—at last! Just plug it into the rear of your 274-N RECEIVER any model! Complete kit, and black metal case, with ALL parts and diagrams. Simple and easy to build in a jiffy. Delivers 24 volts plus B voltage. No wiring changes to be made. Designed especially for the 274-N receiver. All necessary parts for conversion of rest of receiver also included. ONLY \$7.95. TUNING KNOB for 274-N Receiver. 59c ea.

KURMAN #1901 SPDT SENSITIVE RELAY
1700 ohm fast acting coil closes on 2 ma. 2 amp. 5/32" silv. cont. Mtd. on thick Mycalex base 2 3/4" x 3/8". BRAND NEW. \$1.50 ea. or 10 for \$12.50.

HANDSET HANGER

Accommodates all makes and models (W. E. Kellogg, American, etc.) handsets such as 7S-9, 11, 13, etc. Fastens to side of desk or on telephone or radio equipment. Pelt facing protects handset. Black crackle finish only. \$1.95 ea.

LOOK! NO HANDS!

This mike leaves both hands free for mobile QSO's. Fastens to operator by simple snap strap. Western Electric button assures best quality obtainable from any carbon mike. Adjustable. Double action sw. operates push-to-talk or holds on. BRAND NEW only \$1.75 ea. POSTPAID in U.S.A. and CANADA.

R-1/ARR-1 Homing Receiver

Read excellent article in Jan. RADIO NEWS how to convert this receiver to high freq. converter to use with your present receiver. Beautifully built, compact, easy to convert. Like new cond. with 4 acorn tubes and plug. ONLY \$9.95 ea.

WHIP ANTENNA, 4 Sect. Chromed brass. Extends to 23 3/4". For UHF Ant., Beams, etc. 8-32 mtg. ONLY 90c ea.

Telescopic Whip Antennas. BRAND NEW. Extends to 7' in nine sections. Complete with mtg. base. Sealed Cartons. Price \$1.75 ea.

NEED 866 TUBES?

Then you'll be interested in our large shipment of NEW 866 tubes, just received. Same base connections and very similar ratings to 866. Hi-vacuum eliminate hash trouble. Navy used them extensively in various equip. because of this reason. Internal voltage drop similar to 866. Characteristics: Fil. 2.5v. @ 5a. Plate cur. 300ma. (av.) for 2 tubes. Inv. Peak v. per tube, 5,000v. OUR PRICE IS THE SCOOP OF THE YEAR! 2 for \$1.10. Be sure to get yours while quantity lasts.

5-VOLT, 60-AMP. XFMR.

110v. 60 cyc. pri. Ideal for 304TL, VT-127A, etc. NEW. Mfgd. by Kenyon. Limited quant. \$5.95.

2 1/2-VOLT, 10-AMP. XFMR

110v. 60 cyc. pri. 13,000 v. ins. For 836 and 866 rectifiers. NEW. Mfgd. by Kenyon. BUY. \$4.95 ea.

COLLINS MODULATION XFMR

Handles 2,000 watts audio power. BRAND NEW. Pri. impd. 12,000 ohms. Sec. 4,000 ohms. Freq. resp. ± 1 db. to 5,000 c.p.s. Sec. carries dc of mod. amp. 10 1/2 x 3 3/8 x 1 1/2". Wt. 166 lbs. boxed. Orig. boxes. \$59.50 ea.

COAX FITTINGS

UG/21U Straight plug. 25c ea.
CGA 49470 Chassis recept. for UG/21U. 25c ea.
UG/29U Straight Union. Fits UG/21U. 45c ea.
UG/27U Rt. angle adaptor plug. 30c ea.
Of British type snap-on coax. plug and socket combination 10H/701 plug and 10H/628 recept. Set 25c ea.
83-1 SPN/PL-259A Stnd. Coax. Cable plug. 49c ea.
83-1R/50-239 Chassis recept. for above 79c ea.

150,000 NEW SURPLUS TUBES JUST ARRIVED! ALL BRAND NEW!

Lots of rare types, previously unobtainable! VHF, UHF, SPECIAL PURPOSE TUBES OUR SPECIALTY! UHF AND VHF TRIODES

HY-114B UHF Triode. Ideal for battery port. xmtr. 2 watts output at uhf. 98c ea. or 4 for \$3.00.
708A W.E. Grounded Grid Triode. Unsurpassed for superb high signal to noise ratio at VHF. Tube mounts by bolting silver plated grid ring directly to chassis. ONLY \$1.95 ea. or 4 for \$6.00.
HY-615 UHF Triode. 4.5 w. output. 6.3 v. fil. 58c ea. or 4 for \$3.00.

388A W.E. Transmitting Door Knob. Lots of output at VHF. Carbon Anode for max. plate diss. Small physical size. A steal at \$3.95 ea. or 4 for \$13.95.
826 UHF Triode. Full ratings (86 watts output) up to 250 mc! Get real power on 2 meters with a pair of these tubes. BRAND NEW! Get yours NOW 75c ea. or 4 for \$2.40.

RCA 8012 VHF Triode. TANTALUM plate and Tantalum grid! 140 watts Plate Dissipation. Used as osc. or amp. at full ratings up to 500 MEG! C.T. 6.3v. Filament reduces filament lead inductance. All Brand NEW! Reg. price, \$14.50. A large quantity purchase allows us to reduce the price of this tube to only \$1.50 ea. or 4 for \$5.00.
2C21/1642 Twin triode. Used in RU-16/17 Receivers. Get your spares now at ONLY 95c ea. or 4 for \$3.00.

2C22 7193 Triode. A swell tube for experimental use! Output 4 w. at UHF. Grid and Plate buy at 4 for \$1.00.

2C34/RK34 Twin triode. Full ratings (16 w. output) to 250 mc! 6.3 v. fil. Isol. base. 75c ea. or 4 for \$2.40.

UHF PENTODES AND TETRODES

WE717A PENTODE. Hams know this tube's ability to "soup up" any receiver. Has transconductance of 4,000 and is interchangeable with 6SK7. Low loss base and ultra-short leads. Functions better at high frequencies. ALL BRAND NEW! Orig. cost \$3.75 ea. Your price 98c ea. or 4 for \$3.25.

807 Most versatile ham tube. \$1.12 ea. or 4 for \$3.95.
815 Twin Beam Tetrode. Full ratings (56 watts output) up to 125 mc! Requires only 1 watt grid driving power for full output. Brand new. Only \$2.50 ea. or 4 for \$9.20.

829 Twin Beam Tetrode. Ideal for UHF. Brand new in orig. cartons. \$2.80 ea. or 4 for \$10.80.
829B Twin Beam Tetrode. This well known tube is ideal for application at VHF. Full output (86 watts) up to 200 MEG! BRAND NEW! \$3.95 ea. or 4 for \$13.50.
832 Twin Beam Tetrode. NEW. \$2.50 ea. or 4 for \$8.80.

832A Twin Beam Tetrode. 26 watts output up to 200 MEG! BRAND NEW! ONLY \$3.95 ea.

SPECIAL PURPOSE TUBES

WL532 Transmit-Receive Tube. This is a honey! Used for electronic switching of antennas. Throw away your relay now. Every ham should own at least one of these tubes at the low price of only \$1.25 ea. or 4 for \$4.00.
1636 VHF Converter Tube. Specially designed to operate with maximum efficiency at VHF. Low Loss throughout. ONLY \$1.95 ea. or 4 for \$6.95.

TRIODES

211 Power Triode. High power audio (260w.) from \$1.00 pair.
805 Power Triode. 150w. plate diss. Full ratings to 30 mc. 215w. output RF; 370w. audio. class B. \$4.25 ea.
810 Power Triode. This tube is a real powerhouse! 575 watts output up to 30 mc! Carbon anode. Brand new. Full ratings for max. h.f. efficiency. BRAND NEW! Only \$5.95 ea. or 4 for \$21.95.
838 Power Triode. 100w. plate diss. Full ratings to 30mc. 130w. output RF; 260w. audio. Class B. \$3.50 ea.

RECTIFIERS

2X2 H.V. Rectifier. \$.79 ea.
504 and 523 Rectifiers. \$.39 ea.
054 Heavy Duty Rectifier. Used in Teletype equip. \$1.00 pair.
72 High Voltage Rectifier. \$1.25 ea.
702 Heavy Duty Rectifier. \$1.75 ea.
836 H.V. High Vacuum Rectifier. 2 for 1.10
872 H.V. Rect. Merc. Vapor. \$1.75 ea. or 2 for 3.25
CK-1005 Ensu. made into OZ4. 3 for 1.00

CATHODE RAY TUBES

3CP1 3" C.R. Tube. Green Med. Persist. Screen. \$2.95 ea.
3DP1A 3" C.R. Tube. Green Med. Persist. Screen. 14" pin base. For Oscilloscope use. A Real Buy at ONLY \$2.50 ea.
3FP1 3" C.R. Tube. Green Med. Persist. Screen. \$2.95 ea.
5MP1 5" C.R. Tube. Green Med. Persist. Screen. \$2.50 ea.
5NP1 5" C.R. Tube. Green Med. Persist. Screen. \$2.50 ea.

CONTROL AND V.R. TUBES

VR105/OC3 V.R. Tube. \$.98 ea.
VR150/OD3 V.R. Tube. \$.90 ea.
931 V.R. Tube. reg. 55-60v. \$.39 ea.
884 Gas Triode. BRAND NEW. \$1.25 ea.
2050 Gas Tetrode. \$.98 ea.

TUBE KITS

BC-639 Tube Kit. Consists of 14 tubes for famous BC639 portable set. All BRAND NEW AND FOR ONLY \$6.50
Command Receiver Tube Kit. 6 brand new tubes as used in the Command Receivers. All for only \$2.85.
Command Transmitter Tube Kit. 6 brand new tubes as used in the Command Xmters. All for \$1.85.
RU-16/17 Tube Kit. Contains 6 tubes all brand new and for only \$2.85.
GF-11-12 Tube Kit. Contains 4 tubes. 2-89's and 2-837's. All for ONLY \$2.85.
Here's YOUR CHANCE TO GET the special 20-4 Amperage Regulator tube for the PE-120 Pwr. Supply (for BC659) ONLY 49c ea. Quant. prices on request.
6L66 Nat. Tube. BRAND NEW. Don't miss these at 79c ea. or 4 for \$3.00.

★ 4-HOUR MAIL ORDER SERVICE. WE SHIP ANYWHERE.

20% DEPOSIT MUST ACCOMPANY ALL ORDERS, BALANCE C.O.D.

OFFENBACH & REIMUS CO.

372 ELLIS ST. SAN FRANCISCO, CALIF.

PHONE—ORdway 3-8561

METERS ALL BRAND NEW WESTINGHOUSE

3" Round 0-1 Mil DC with bad & good colored scale; can be used in tube checker.....
Additional 0-1 scale provided.....
3" Square 7.5V AC.....
3" Round & Square 0-15 Mil DC.....
3" 0-1 Amp. DC.....

Each \$3.45

WESTON

4½" Round 0-5 Amp. AC with a 0-200 amp scale..... \$3.95
2" Round 0-1.5 Mil..... 2.25
2" Model 507 0-10 output units, (0-50 microamp movement) in wooden case..... 4.95
Without wooden case..... 3.95

GENERAL ELECTRIC

3" 0-200 Mil DC..... \$3.45
3" Round 0-1 Mil DC..... 3.45

WESTERN ELECTRIC

3" Round 100-0-100 Mil DC..... \$3.45

MISCELLANEOUS

3" Round Beede 0-1000 Mil DC..... \$ 1.95
3" Round Triplet 0-150V AC, 60 cycle..... 3.45
3" Round Burlington 0-75 amp. AC..... 3.45
Roller Smith portable lab 0-150 Mil DC with handle; 5½x6x3½..... 19.50
Roller Smith portable lab 0-150 Mil DC with handle; 5½x6x3½..... 19.50
2" Triplet 0-35 Mil DC..... 2.25
2" Round U.S. gauge 5-0-5 amp DC..... .69

RADIO TUBES

Standard	Brands—All Brand New	
2C34/VT	6H6	726A ...\$14.95
224	6J6	831A
2C43	6K6	807
2C34	6SA7	815
2X2	6SH7	837
3C24	6SQ7	843
3C30	6X5	922
4B25	15R	8012
6CF	30 Special	1626
5BP1	531	2051
5FP7	717A	2051
6AK5	724A/B	7193
6AL5	724B	9002

SELSYN MOTORS

50 V. 50/60 cycles. Can be used to turn small beam antenna or as indicators. 3½" diameter x 5½" high. Two can be used in series on 110V. A.C. Brand New.
Per Pair..... **\$4.95**



TS-10 Sound power handsets in original export packing. Brand New... Each \$15.00
2 for

BC-223A Transmitter. 2000 to 3000KC without tubes—with one tuning unit. Brand New \$12.95
With extra tuning unit 3000 to 4500KC.....\$14.95

INCLINOMETER

Jaeger E3-2—In 3-inch round case. Has an adjustment knob for leveling purposes. This is Govt. Surplus, Brand New. It costs the Govt. many times the low price we ask..... **\$7.95**

NAVY TBY TRANSCEIVER

28 to 80 Megacycles
Frequency equipment. Types of transmission CW. Telegraphy and Telephony Power output, .5 watts. Complete with tubes, aerial. Head Set, crystal controlled. Microphone, 3 spare tubes and canvas carrying case..... **\$32.50**

Watt-hour METERS

GE 1-16 single phase 60 cycle 115-120 volt 5 amp.—two wire—glass case.
WESTINGHOUSE—metal case—115-120 volt 60 cycle—5 amp. single phase.
SANGAMO—metal case—115-120 volt 60 cycle—5 amp. single phase..... **\$6.95**
Santamo 10 and 25 amp.....\$7.95



Prompt Delivery—25% deposit required on C.O.D. order. Shipped F.O.B. New York—Write Dept. RN7

MICHAEL STAHL, INC.

39 VESEY ST.

New York 7, N. Y., WO 4-2882

voting for vice presidents, and a decision on these officers will have to be made by the club's board of directors. Editorial staff of this club includes Irving R. Potts, editor; Carroll H. Weyrich and Bernard L. Ahman, Jr., broadcast band; James J. Hart, short-wave; Earl Roberts and Gail Beyer, amateur; and Carleton Lord, special features.

* * *

Verification Data

These current QRA's from Fellers, Hawaii, were copied from recent verifications: Norwegian State Broadcasting System, Short-wave Division, Oslo, Norway—*Radio Sweden*, Short-wave Section, Stockholm, Sweden—Directeur du Cabinet du Governor General, Service Information, *Radio Noumea*, Noumea, New Caledonia—British Far Eastern Broadcasting Service, P.O. Box 434, Singapore, Malaya—Directorate General, Broadcasting House, *All India Radio*, New Delhi, India—Program Director, English Foreign Broadcasts, *Radio Indonesia*, Batavia, Indonesia—Northern Rhodesia Broadcasting Station, P.O. Box 209, Lusaka, Northern Rhodesia—Jean Pison, English Department, *Radio Saigon*, Bureau and Studios, 86 Rue MacMahon (P.O. Box 412), Saigon, Fr. Indo-China—*Radio Clube de Mocambique*, Caixa Postale 594, Lourenco Marques, Mozambique—*Radio Brazzaville*, Poste National Francaise, Brazzaville, Fr. Equatorial Africa—"The Goodwill Station, OTC," Leopoldville, Belgian Congo—Hong Kong Broadcasting Station, Gloucester Building, 2nd Fl., Hong Kong—Swiss Short-wave Service, 28 Neuengasse, Berne, Switzerland.

QRA for reports on Pakistan stations is I. A. Ansari, Esquire, Deputy Engineer-in-Charge of High-power Transmitters, Karachi, Pakistan; no IRC necessary. (Fried, Mich.)

YSUA, *Radio Mil Cincuenta*, la avenida SUR No. 50, San Salvador, Republica de el Salvador, C.A., verified by letter in Spanish; however, this station verifies reports written in *English*. (Weisberg, N.Y.)

Radio El Mundo, 555 Calle Maipu, Buenos Aires, Argentina, QSL'd with white card over pale blue call letters; took two months by ordinary mail.

Pearce, England, received reply on report of *English* transmissions from *Romana Libera*, 6.205; QSL card (map of Europe with position of Roumania indicated) came from Societatea Romana de Radiodifuziune, Bucharesti, Str. General Berthalot No. 60, Republica Populara Romana. Kary recently received verification from this QRA for his report on the 9.252 channel.

Kary has also received verification from BEA8, 9.730, Nanking, written just before that station was taken over by the Chinese Communists.

TGDA, 7.462, Quezaltenango, Guatemala, verifies with pink and red card printed in blue and showing a picture of a building, has message on reverse side; signed by Fernando Behar Al-

cahe; QRA is Independencia 8; verified in 20 days. (URDXC)

QRA for Tananarive is FIQA, *Radio Tananarive*, Haut Commissariat de la Republique, Service General de L'Information, Service de la Radio-diffusion, Tananarive, Madagascar; for Belgrade it is *Radio Beograd*, Secretariat, Belgrade, Yugoslavia. (Pearce, England)

WRA-11, 18.450, *RCA Communications, Inc.*, British P.O. Box 57, Tangier, Morocco, wrote: "While it is not our practice as a commercial communications company to encourage amateur reception of our point-to-point directed signals, I am pleased to confirm that WRA-11 was operating on a point-to-point radio telephone circuit between *RCA Communications, Inc.*, in Tangier, Morocco, and our stations in New York." Signed K. L. Hancock, engineer-in-charge, transmitting. (NNRC)

* * *

Last Minute Tips

Budapest, recently returned to the air on s.w. for first time since war's end, is reported to have moved from 9.700 to 9.818 in the 31-m. band; the frequency in parallel is approximately 6.205 (or 6.250?). (Swedish DX program)

All Communist-controlled Chinese outlets have ceased announcing former "X" calls, but the calls may not have been dropped entirely.

Evening schedule for LRU, 15.29, Buenos Aires, Argentina, appears now 2100-0100; LRY, 9.455, at 2115-0100. (Rosenauer, Calif.) These carry international programs as does LRS, 11.88. Laubscher, South Africa, hears LRY well to shutdown 0100.

VLX3, 9.610, Perth, parallels VLW3, 11.830, to 0500 sign-off; returns 0515 via VLX2, 6.130, and VLW5, 9.610. (Kary)

K4AF, 14.240, Pentagon Building, Washington 25, D. C., heard recently 1215-1256; is headquarters for "MARS" (Military Amateur Radio System); nice card and verifies promptly. (Ferguson, N. C.)

Pearce, England, flashes that *Eng-*

Arne Skoog, DX Editor for Radio Sweden and head of International League of Short-wave Editors, in process of recording a DX broadcast in Stockholm.



RADIO & TELEVISION NEWS

lish programs from Rome on 9.63, 11.81, are now at 1410-1445, news 1430; that Warsaw, 6.215, Poland, now has news 1430, and that Sofia, 7.671, has adjusted *English* broadcasts to 1520-1530, 1645-1700.

The Chinese station on approximately 11.685, mornings, seems to have an irregular schedule. (Rosenauer, Calif.) This is believed to be BCAF (old XGAF, Nanking, now removed to Taiwan, Formosa). Sanderson, Australia, reports this one at 0545 with *English-Chinese* lesson, then music. Gaynor, Calif., says recently it has been closing 0930 instead of former 1000; he notes no *English* except for announcing Western musical numbers.

Sampat, India, informs that *Radio Jodhpur*, Rajputana, is currently on 3.775 from 0800 to 0930 weekdays and Sundays 0800-1000, news 0840; he adds however, that was to move shortly to 8550 for the summer.

DTSP (?), 15.105, Munich, Germany, tuned 0906 when was talking to New York; press report from Vienna followed to 0928; at 0930-0945 in German, then announced and continued with press reports from Berlin; signed off 0955 point-to-point with "Voice of America."

URDXC reports that *Radio Martinique* is now a National Station and that within a few months "will be bound to the French Broadcasting System," when will be equipped with a high-powered transmitter ("double 25 kw.") and will start in service by 1950. It is believed the increased power will enable Martinique to be heard even in the Far East. QRA is Le Directeur du Service de L'Information, *Radio Martinique*, Department de la Martinique, Fort-de-France, Martinique, French West Indies; is now on 9.700 with 1.2 kw., heard around 1830.

Summer set-up for West Coast beam from *Radio Australia*, 2330-0045, is VLA8, 11.76; VLC9, 17.84; VLG6, 15.320; and to Africa, VLB5, 21.540; Sunday DX session remains 0025. In the British Isles-Europe beam 0200-0315, VLB9, 9.58, has been replaced by VLB6, 15.200.

Acknowledgment

Many thanks for the FB reports, fellows. Keep them coming! K.R.B.

**For The Best in Tape Recorders
Look For The TWIN-TRAX* Label**

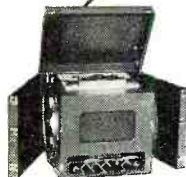

TWIN-TRAX
4-HOUR PLAY



TWIN-TRAX STANDARD



TWIN-TRAX
PORTABLE

This label identifies the original and only TWIN-TRAX Recorder, manufactured exclusively by Amplifier Corp. of America. It is your assurance that the recorder bearing this label has the professional specifications that have made TWIN-TRAX the "choice of engineers everywhere."

TWIN-TRAX was the first commercially available two-channel tape recorder. Imitators have announced two-channel recorders with similar names and similar external appearances. But it's the performance that counts, not the appearance. And the performance of TWIN-TRAX recorders cannot be duplicated. Our leadership in the tape recording field has been undisputed since we designed the first magnetic recording amplifier in 1936.

Remember, imitative Twin-Track or Two-Track does not mean TWIN-TRAX, because TWIN-TRAX is the registered trade mark of the best in tape recorders, made exclusively by Amplifier Corp. of America. Send today for literature on the exclusive TWIN-TRAX line, and discover why TWIN-TRAX is the recorder engineers are buying.

*Registered Trade Mark.

AMPLIFIER CORP. OF AMERICA

398-2 Broadway

New York 13, N. Y.

OUTSTANDING VALUES NOW AVAILABLE

SNYDER AUTO ANTENNAS

Exceptional values—top quality.

Side Cowl—2 point mounting—fine chrome finish—66" extended—sturdy construction—with shielded lead. **\$1.79** each

Top Cowl—Universal mounting joint—sturdy construction—chrome finish—60" extended—with shielded lead. **\$1.99** each

ICA 100" Side Cowl antenna. High chrome finish. Shielded lead. Firm construction. **\$1.99** each

Five to a carton..... **\$9.50**

6 INCH AUTO SPEAKER

6 volt, 4 ohm. Direct Auto Radio Replacement. **\$1.39** each

Standard 4 Prong Replacement Vibrator. **\$1.29** each.
10 for **\$11.95**

**CLARK 15 WATT
AMPLIFIER KIT**



Another popular Clark kit. All first line parts to make an exceptionally fine unit.

- 6 tubes—2—6SQ7, 2—6V6, 1—6SN7, 1—5Y3GT. • Mike and phono input. • Separate treble and bass controls. • Heavy steel chassis and cover. • Frequency response 30-17000 CPS + 1DB. • Output impedances 4-8-16-500. • Hum level 65 DB below rated output.

Kit comes complete with all tubes and parts—ready for installation. Schematic, layout and instructions.

ONLY **\$18.95** each

TV POWER TRANSFORMER

730 volt C.T. 275 ma. One 63 volt winding—two 5 volt winding. Size, 3 1/2 x 4 1/4 inches. Mounting Centers 3 x 3 3/4 inches. Half shell mounting type. Fully shielded.

\$6.75 each

SPECIAL!

4-tube, AC-DC Amplifier. A terrific buy! Has tone and volume control. High quality parts throughout. Uses two 35L6, one 35Z5, and one 12SL7. Only **\$2.95**. With tubes, \$5.29.

WRITE FOR OUR LATEST CATALOG

Radio Parts Company, 614 RANDOLPH ST., CHICAGO 6, ILL.

WHERE TO BUY IT.....

WHOLESALE RADIO

of Baltimore

EVERYTHING YOU NEED FOR TELEVISION ANTENNAS AT ROCK-BOTTOM PRICES

GET TOP T.V. & F.M. RECEPTION with "Ranger" HI-LO ARRAY

ANTENNAS

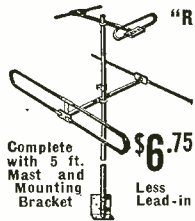

Duo-orienting folded dipole with reflector. Range 30-216 mc. All T.V. Channels and FM. D.B. gain is "plus" 4.2 for each section over dipole. Each section may be coupled or operated with separate transmission lines. Individually rotatable for maximum signal strength.

Complete with 5 ft. Mast and Mounting Bracket \$6.75 Less Lead-in

LIGHTNING ARRESTERS RCA. Strap-on style. For 300 ohm lead. **66c**

STEEL EXTENSION POLES 4 ft. 1 1/4 di. Crimped to connect inside of ant. mast. **95c**

GUYWIRE 6 strand # 20, per 50 ft. **29c**

72 OHM COAXIAL CABLE RG59U. (5c per ft.) 100 ft. **\$4.35**

300 OHM TWIN LEAD (\$1.95 per 100 ft.) 1,000 ft. **\$12.75**

WE HAVE THE COMPLETE LINE OF AMPHENOL & TRICRAFT ANTENNAS

In Kit Form "EICO"

5" SCOPE

Model 400-K **\$39.95**

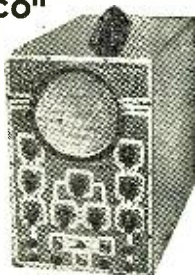

For AM, FM and TV. Horizontal sweep 15 to 30,000 cycles. Linear sweep with 884 gas triode. Graph screen for measuring peak to peak voltage. Horizontal and vertical frequency response from 50 cycles to 50 Kc. Input impedance—1 megohm and 50 mmfd. Etched panel for long life. Tubes—2-6XJ7, 2-5Y3, 1-884, 1-5BP1. Provision for ext. synchronization, test voltage and intensity modulation. Deflection sensitivity—.30V. per in. full gain. Detailed instructions and pictorial diagrams included. **NOTHING ELSE TO BUY.** Operates from 105/130 V. ac. 50/60 cycles. Size—8 1/2" W x 13" H x 17". Eico Vacuum Tube Voltmeter in Kit Form. Model 221-K. **\$23.95**

TELEVISION PARTS FOR ALL 630 T.S. CIRCUITS

- T104—Horizontal (Synch.) Discriminator Transformer. Interchangeable with RCA type **\$1.56**
- 208TS **48c**
- T112—Width Control Coil. Interchangeable with RCA Type **201R1**
- T118—Horizontal Deflection Output Transformer. Interchangeable with RCA Type 211T1 or **\$5.85**
- 211T3
- T121—Deflection Yoke. 8.3 MH vertical 50 MH. Interchangeable with RCA type 201D1 **\$4.95**
- T122—Focus Coil. 247 Ohms D.C. resistance. Interchangeable with RCA type 202D1 **\$3.90**
- R131—Picture and Sound Control. 10,000 ohms and 1 megohm dual control with power switch **\$1.50**
- R168—Vertical and Horizontal Hold Control. 1 megohm and 50,000 ohms dual control. **\$1.20**
- T120—12 Channel Tuner. Complete with 3-6J6 tubes. Pre-aligned KRK-2 **\$45.00**
- H111A Shield for Voltage Divider **\$1.50**
- H102—Bracket for Tuner Shaft Bearing **18c**

The Above List Shows Just a Few Values! Write for Complete Listing.

WRITE DEPT. QR. 80 TODAY FOR OUR FREE MONTHLY "FYI" BULLETIN Phone MULberry 2134

WHOLESALE RADIO PARTS CO., Inc.
311 W. Baltimore St.
BALTIMORE 1, MD.

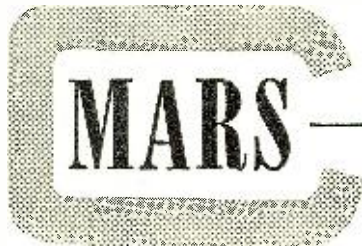

Station of the Month

THE Air Force Station of the Month is W5AAF at Kelly Field, Texas, the outstanding station of the Air Materiel Command. It was conceived by Lt. Col. Walter W. Downs, Communications Officer for the San Antonio Air Materiel Area in the Fall of 1946 and has been nurtured to robust maturity by Capt. Chester B. Lewis, W5MTS, present trustee, and Staff Sergeant William Fortune, Jr., W5MGO, head operator.

First appearance is striking. It doesn't look like a ham shack at all. There is no haywire. All of the control lines to the transmitters and beam antennas are neatly cabled and *there is a rug on the floor.* The entire room is spotless. The conventional QSL wallpaper is conspicuous by its absence. A certificate of recognition from the ARRL for W5AAF's work in the Texas City disaster and a membership certificate in the League, neatly framed, are the only adornments on the walls.

Five transmitters with the assistance of five antennas have garnered thousands of QSO's for W5AAF. The BC-610 does its share of the work; with tuning units for 20, 40 and 80 in the exciter deck and the final tank coils conveniently located, band-hopping can be done in mighty little time. The antenna selection is made from the miniature "H-frame." EO-1 cable comes down to the floor and up the wall, and the transmitter is out far enough to permit easy access for trouble shooting. Rocks are used on

all bands; but if going gets rough, the boys go v.f.o.

Four T4/FRC transmitters are controlled from a second operating position. Bandswitching here is almost oversimplified since each transmitter has its individual antenna, and it is merely a matter of flipping one switch to jump bands.

Receiver preference may be exercised by the op from an SX-28, an RME-99 or a super-pro. The building was selected for its low noise level location which goes down another db. when the parasitic arrays are used.

Beams are the home-grown variety but constructed as neatly as any store-bought job on the market. Both 10- and 20-meter beams use a folded dipole as the driven element and close spacing for reflector and directors. The one big heartbreak for W5AAF was when the CAA ordered the 115-foot steel tower cut off at 65 feet since it was regarded as a hazard to air traffic at the field. Other antennas are a tri-flex for 20, a doublet for 40 and a long wire for 80 meters.

S/Sgt. "Bill" Fortune, Jr., used the flame-proof knob from "Bill" Senior's 100-ampere solid silver key as a teething ring and was lulled to sleep by the drone of the *Bemwood* synchronous rotary that signed 5LX. It was impossible for him to escape being a ham.

Captain Lewis has held a ticket since 1929, which almost makes him an old-timer. His first call was W9ZZS. In addition to being trustee of W5AAF, he is Communications Offi-

S/Sgt. Bill Fortune, Jr., W5MGO, chief op at W5AAF, doing some brass pounding on 40.

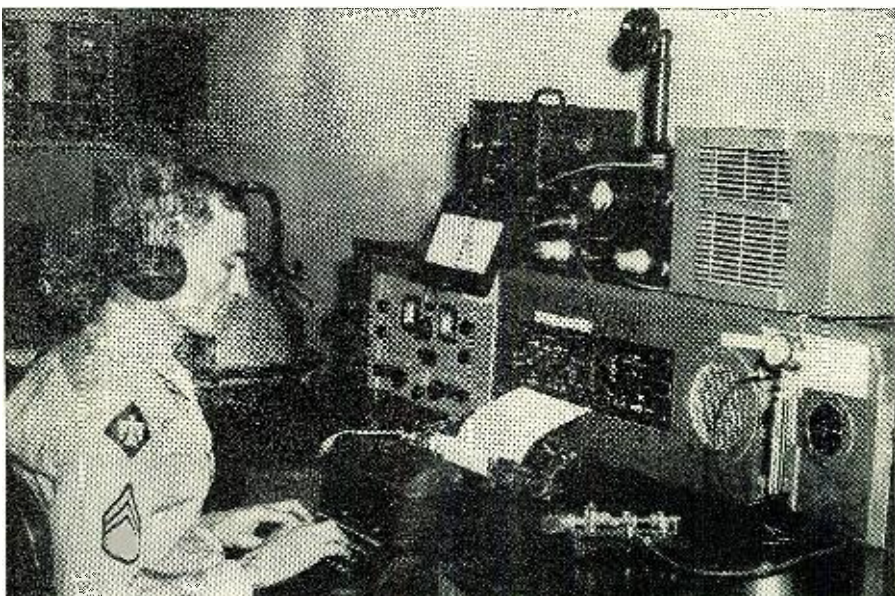

cer, Technical Services Staff, San Antonio Air Materiel Area.

W5AAF keeps a regular schedule with K8AIR at Wright-Patterson Air Force Base at Dayton, Ohio; and Captain Jim Ford, MARS Command Director for the Air Materiel Command uses W5AAF as a criteria for other AMC MARS installations.

What's New in Radio

(Continued from page 68)

back immediately. The tape can be erased completely or in part, and can be reused any number of times for different recordings. To play back the tape, simply turn the play-back knob,



and the magnetic impulses recorded on the tape are instantly converted back to sound.

The unit is housed in a maroon, simulated leather case with carrying handle. It operates on 60-cycle, a.c. current, and is available with radio (Model RT-50R), or without (Model RT-50). The radio tuner compartment can be used for storing extra reels if tuner is not desired.

8-INCH REPLACEMENT SPEAKER

The Permoflux Corporation, 4900 W. Grand Avenue, Chicago, Ill., manufacturer of a complete line of speakers, announces that it has added to its listing a new eight-inch speaker with an 87-ohm field.

The new speaker model, No. 7529, is an exact replacement for the Motorola VT-107, VT-121, and 12VT-16 sets. In addition to the new unit, the company carries both permanent magnet and electromagnet jobber replacement speakers.

NEW HYTRON HELPS

As a result of its Service Technicians' Tool Contest, two unique items are being offered by Hytron Radio & Electronics Corp., Salem, Mass., both of which are available through all of the company's jobbers.

One of the units is a tube lifter designed to be used for all standard, GT, G, and metal tubes. It can be used equally as well for removing vibrators and various types of plugs. This new tool can lift the units out of their sockets no matter how firmly they are lodged and can be used wherever tugging and prying would normally have been necessary.

The other unit now being produced

July, 1949

SPEAKERS

THAT SPEAK FOR THEMSELVES!

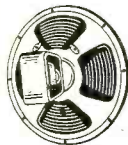

MAGNAVOX SPEAKERS

- 8" 680 ohms field with 6V6 P.P. output, cord & plug \$3.69
- 12" P.M.—21 oz. magnet, 6V6 P.P. output, cord & plug 5.95
- 12" 1,000 ohms field, 6V6 P.P. output, cord & plug 5.95
- 12" 600 ohms field, 6V6 P.P. output, cord & plug 5.95

COMPARE THESE PRICES

- All Alnico V
- 3" P.M.—.68 oz. \$0.99
- 3" P.M.—1.47 oz. 1.15
- 4" P.M.—1.47 oz. 1.15
- 4"x6" P.M. 1.69
- 5" P.M.—1 oz. .99
- 5" P.M.—1.47 oz. 1.15
- 6"x9" P.M. 2.39
- 8" P.M.—2.15 oz. 2.75
- 8" P.M.—4.64 oz. 2.95
- 8" P.M.—6.8 oz. 3.69
- 10" P.M.—6.8 oz. 3.75

- SENCO has RCA SPEAKERS too!
- 6" P.M.—3.16 oz. Alnico V with tapped output transformer, 4M, 8M, 16M ohms to voice coil. Individually cartoned only \$2.59
 - 2" x 3" P.M. Alnico V \$0.79
 - 12" P.M. Alnico V 3.95
 - 12" P.M.—6.8 oz. Alnico V 4.75

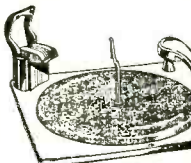

A Sizzling SENCO Special! VOLUME CONTROLS

- With switch—all 3" shaft
- 10,000 ohms
 - 25,000 ohms
 - 50,000 ohms
 - 100,000 ohms
 - 250,000 ohms—Tapped
 - 500,000 ohms—Tapped
 - 1 meg. ohms—Tapped
 - 2 meg. ohms—Tapped
- only 44c ea.

Records Change Smoothly With This Famous Make AUTOMATIC RECORD CHANGER

- Changes 10" or 12" records without a lift. 110V, 60 cy. Complete with crystal cartridge arm at an amazing \$11.95

GENERAL ELECTRIC COIN SWITCH

Radiomen will appreciate this value! For juke boxes, radios, etc. Model 3TSC9AA1. 110 V, 60 cycle. A great saving at \$2.95

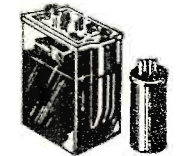

27 AMP WILLARD BATTERY & VIBRATOR

2 volt new-type storage battery and 2 volt vibrator. Used in GE Model # 530. Most dependable for all farm sets. One in a carton. Model # 27-2. Battery alone \$1.79. Vibrator alone 7 prong .99. SAVE! BUY BOTH FOR THIS AMAZING LOW PRICE 2.69

Another SENCO Special! 6 volt Auto Vibrator, 4 prong \$1.99

MINIMUM ORDER \$2.50: When ordering, send 25% deposit for all C.O.D. shipments. Include sufficient postage—excess will be refunded. Orders without postage will be shipped express collect. All prices F.O.B. New York City.

Radio Men Who Know

SAVE AT SENCO

Write for FREE SPECIALS OF THE MONTH BULLETIN!

SENCO RADIO, INC., Dept. K, 71 West Broadway, New York 7, N. Y., Tel. BEekman 3-6498

SCPI	9LP7	304TH	\$1.95
5API	3DP1	371B	.70
5AP4	1630	2X2	.25
4AP10	8013	878	.98
		800	.65
		559	.40
		126P7	7.75

GOULD GREEN

252 Greenwich St., New York, N. Y.

POWER TRANSFORMERS

- You'll say, "More power to you, Mr. Senco"—when you see these fine transformers! 110 V., 60 cycle, fully shielded, flush mount.
- 90 ml—6.3V @ 3.3 amps—5V @ 3 52.65
 - amps 7.00V CT @ 3 2.79
 - 100 ml—6.3V @ 3 amps—5V @ 2 2.79
 - amps 7.00V CT @ 3 2.95
 - 120 ml—6.3V @ 3 amps—5V @ 2 3.19
 - amps 7.00V CT @ 4 4.25
 - 150 ml—6.3V @ 3.3 amps—5V @ 3 4.25
 - amps 7.50V CT @ 3.3 amps—5V @ 4.25
 - 200 ml—6.3V @ 3.3 amps—5V @ 4.25
 - amps 8.15V CT @ 3.3 amps—5V @ 4.25



RECORD CHANGER MOTOR

A special buy! For Seeburg changer, complete with rim drive wheel \$1.43

CARTRIDGES, Brand new FN88 Sure Crystal \$1.69

DUAL HEADSETS, Signal Corps 2,000 ohms, 6 ft. cord & tips, brand new, individually boxed. A saving at \$1.49

LOOK AT THESE amazing SENCO SPECIALS

See How Much More Your Dollar Buys at SENCO

TUBES galore

All brand new! R. M. A. Guarantee! Immediate Delivery! Individually cartoned!

SPECIAL DISCOUNT!

When ordering 25 or more assorted tubes, deduct 5c from the price of each tube!

695E EA.	107GT	7C6	5T4
38/44	126GT	7E8/1201	6A06
57A5	128ATGT	7E7	6C8
V99	128ATGT	7E8	6B7
X99	128GT	128F5	6D6
1U5	128N7GT	747	6E8
2A7	128Q7GT	128K7GT	6F8G
2X2	14B2	14A7	6Y4G
6C4	14C7	12AT8	6L5G
6C8G	14F8	12AU7	6N6G
6D4G	14F8	12BA6	6A0G
6E8/VT70	14T8	12BE6	6V7
6SH7GT	19T8	12B7	6T7G
6SR7GT	2A	12B7	6X4
6T8G	2A	12B7GT	7C5
7Y4	27	12B6G	7E7
12A6	30	12B7	7C7
12ASGT	31	12B9GT	7E7
12F5GT	32	12B7	12A8
12H6	35/51	28D7	14B6
12K8	33/8GT	33L7GT	75
26	35W4	34	83
36	35Y3	33Z4GT	2051
71A	35Z3	46	59C EA.
77	35Z6G	46	074
133	38	50L6GT	11E3
1F4	45	50Y6GT	11E3
1U4	47	50Y6GT	11E4
1V	50B5	56	11E5
3A4	55	59	11NGG
5A4	58	50C EA.	2W4
5B4G	58	1A5GT	2W4
5W4	76	1A6	4A6
5X4G	76	1A7	4B6
5Y4G	80	1AB5	6AB5/6N5
5Y9GT	85	1C5	6AV6
5Y9GT	88	1C5G	6BE6
6AD7G	88	1C6	6BG6G
6AF5G	88	1C7G	6BH6
6AT6	1A4P	1B5/25S	6C6G
6AT6	1B5/25S	1D7G	6D4
6AU6	1Q5GT	1E5G	6J8G
6ASGT	1R5	1E5G	6L5/6G5
6B5	1S5	1F5G	6W4
6BE6	1T5GT	1F7G	6W6
6C6	2A5	1G6G	6C3
6C6G	2B6	1G6G	12A
6F6G	3B7	1H4G	12AT7
6H6GT	4B3GT	1H6GT	14B7
6J6GT	4B3GT	1H6GT	14A7/12B7
6K7GT	6D7	1J6G	1497
6K7GT	6F5GT	1K5GT	15B7/482
6K7GT	6C6G	1R4	483
6M7GT	6P5GT	2A3	70L7GT EA.
6M7GT	6R7GT	2A3G	69C EA.
6SA7GT	6S17GT	3A5	6A3
6SB7	6SN7GT	3D6	6AC7/1852
6SR7GT	6SR7GT	3E6	6L7G
6SR7GT	6V5	3L4	11L7GT
6SR7GT	6Y6G	3V4	11M7GT
6SR7GT	6Z5	5Z4	11N7GT
6U6GT	7A4/XXL	5Z4	11P7GT
6V6GT	7A5	6A3	11Z6GT
6X5GT	7A6	6A4	6A4
12AH7GT	7A8	6A6	89C EA.
12AU6	7A7	6A7	6L6GA
12SH7	7B6	6A75	81

Hard to get tubes? Our tube stock is constantly being expanded. If your tube is not listed, write us!

PEN-OSCIL-LITE

Extremely convenient test oscillator for all radio servicing; alignment • Small as a pen • Self powered • Range from 700 cycles audio to over 600 megacycles u.h.f. • Output from zero to 125 v. • Low in cost • Used by Signal Corps • Write for information.

GENERAL TEST EQUIPMENT
38 Argyle Buffalo 9, N. Y.

BLISS Electrical Training

Intensive 32 weeks' residence course in fundamentals of industrial electrical engineering, including radio and electronics. Extensive laboratory, shop work, drafting. Prepares for electrical technician and engineering aides in communications, power, manufacturing, business machines, sales, service. G. I. approved. 56th year. Enter Sept. 6, Jan. 9. Catalog. 7698 TAKOMA AVE. WASHINGTON 12, D. C.

**You Can't Match these
MID-AMERICA Values!**

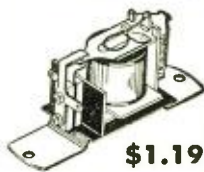

**110-VOLT DC
PLATE LOAD
RELAY**

6000-ohm coil. SPST normally open contacts. Extra sensitive and used for many applications. 1 1/2" high, 1 1/4" wide, on 1 1/2" mtg. ctrs.
MA-1903.....**\$1.19**

Silver Mica Button Condensers

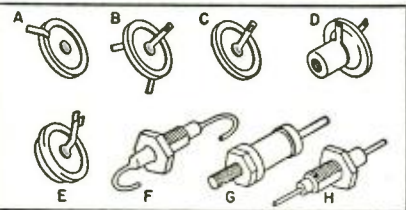

\$7.50 per 100 (all one type)

MA-3530 (G) 20 mmf	MA-3505 (C) 360 mmf
MA-3501 (D) 30 mmf	MA-3509 (A) 700 mmf
MA-3531 (F) 55 mmf	MA-3506 (B) 700 mmf
MA-3503 (A) 75 mmf	MA-3510 (C) 700 mmf
MA-3523 (H) 75 mmf	MA-3502 (D) 500 mmf
MA-3504 (A) 200 mmf	MA-3507 (K) 500 mmf
MA-3519 (F) 250 mmf	MA-3518 (A) 2000 mmf

No. 18 2-conductor Wire & Drum

Used for running 110-volt AC lines, extension speakers, etc. Full 175 feet of highest quality wire with tough, weather-resistant insulation. Complete with handy drum for spooling wire for storage. Limited quantity.....**\$2.39**

**BRAND NEW
METERS**



Dehr Model 310 meter for all-around ham and test applications. 10 ma DC basic movement. 3/4" diameter flange; 2 1/2" body, 1 1/2" deep. Stock up on these while they last
MA-2036.....**\$1.95**
Each

**Iron Core FM and AM
IF TRANSFORMERS**

Highly efficient for new construction and replacement. Hi-Q adjustable iron cores provide high selectivity and gain. Only 2 1/2"x1 1/2" square; spade lug mounting.
MA-2296 10.7 MC IF Transformer.....each **49c**
MA-2039 455 KC IF Transformer.....each **35c**

GRILLE CLOTH

Never before at our low price! Highest quality, golden-tone grille cloth, styled to harmonize with all cabinet designs. Generous 50" width.....**\$1.79**
per yard

Intercom Transformer Set

One transformer to match voice coil to grid, another for 50L6 and similar output tubes. Both of these fine units PLUS a momentary DPDT spring return push-button switch for less than value of one transformer alone! These are small, strap-mounting transformers.

Only 98c for All Three Units!

THIS MONTH'S SPECIALS!

T-17 Microphone and plug; used; good.....	79c
25 mh iron core RF choke; 100 MA DC.....	19c
25 mf butterfly condenser.....	32c
50 mf butterfly condenser.....	32c
Mercury switch; flexible 18" leads.....	52c
Brand new BC-366 Jack Box.....	19c
SIDT Slide Switch; black bakelite knob.....	15c

ORDER FROM THIS AD!

Send 25% deposit with order. Pay balance plus postage on delivery. Get your name on Mid-America's select mailing list and get first crack at latest, greatest values in radio parts, electronic equipment, tubes, etc. Send orders to Desk E-79. Minimum order \$2.50.

MID-AMERICA CO. Inc.

**2412 S. Michigan Avenue
Chicago 16, Ill.**

is a soldering aid. While the iron keeps the joint hot, the fork tip of the long, slender object (soldering aid) straddles and grips the ends of wires when unsoldering mechanically solid joints. It handles like a pencil, leaving the work visible. Other ways in which this tool can be of help are in separating and positioning wires, plugs, contacts, etc.

-50-

**CIVILIAN SEAGOING
POSTS OFFERED**

APLICATIONS for civilian positions as radar technicians are being accepted by the Transportation Corps of the Department of the Army. The posts will be on board the sea transport vessels operated by the Army for the International Refugee Organization in connection with the resettlement of DP's from Europe and elsewhere.

Applicants must be U. S. citizens available to leave on short notice. If accepted for such employment, they will join their ships at New York and set sail for Europe, South American ports, or other ports around the world. Salary offered is \$4030 a year, plus maintenance. Additional information will be sent on request by the Crewing Section, New York Port of Embarkation, First Ave. and 58th St., Brooklyn 20, New York, N. Y.

-30-

**YOUR ATTENTION,
PLEASE**

HOWARD BROWNING has written us asking that we help in contacting those persons who attended the RMA-sponsored Town Meeting of Radio Technicians in Chicago.

According to Mr. Browning, a number of the technicians in the audience turned in their lapel tags to indicate they had earned Certificates of Leadership in Television. The committee in charge now has the tags which prove the owners' right to the certificates but the registration tags of these persons have been mislaid.

He is asking that the technicians involved send their full names and addresses to Room 805, 21 East Van Buren Street, Chicago 5, Illinois, in order that their certificates may be properly inscribed and then forwarded to those who worked so hard to achieve this honor.

-30-

**TELEVISION
TRAINING COURSE**

A TRAINING course in the principles and practices of television maintenance is offered to radio men by the General Electric Company Tube Division, through G-E or Ken-Rad tube distributors.

Designed for the more than 30,000 small radio service organizations throughout the country, the course aims to extend the service technician's knowledge of electronics to include a thorough grounding in the principles and techniques of television.

Eight lessons comprise the instruction unit, and these may be undertaken by correspondence or group study methods. A graduation certificate will be awarded those completing the series.

-50-

Mobile Transceiver

(Continued from page 44)

from the front end, and the tuning condenser is mounted thereon with a small strip of polystyrene. The shaft is coupled to the dial with an insulated coupling. The dial is a 3" National type "BM," and is illuminated by a dial light projecting through the front panel behind the dial. The other end of the hairpin tank circuit is fastened to a small ceramic pillar. The coupling link is also mounted on ceramic pillars. Output and power jacks are on the rear.

Alignment and Testing

The receiver and transmitter may be tested with a 300 volt 100 ma. power supply from the home location. The most obvious point to begin with is the common audio system. First let the filaments warm for a few seconds, then turn on "B plus." The relays should snap over. The relay control circuit should be tested by pushing the test button, and if both relays operate positively, all is well. Touching the grid of the first audio amplifier should produce a loud hum. To test the audio on transmit position, clip a pair of phones (through a condenser) across the secondary of the modulation transformer, plug in the microphone, press the switch, and whisper, "Hello." Don't turn up the gain too high, or you will be minus a pair of phones, and possibly eardrums. When you are convinced that the audio is working in both positions, you can proceed to align the receiver. A signal generator is helpful, but not necessary. Plug in the 6C4 detector tube and advance the regeneration control. The familiar superregenerative rushing should be heard at about midscale. Now, tune your regular communications receiver to about 10.7 mc. Now, wrap an insulated wire around the grid lead of the mixer stage of your communications receiver, and tune in a signal close to 10.7 mc. There are usually a number of foreign broadcast stations operating near this frequency. Connect this wire to the grid of the 6AK5 mixer stage. The signal should also come through the superregenerative detector. Adjust the slugs on the first i.f. transformer for maximum signal. The i.f. is now aligned. Since the circuits are fairly broad, no fine alignment is necessary. Getting the local oscillator working is the next job. When the local oscillator power is applied, a reading of about one ma. should be gotten across the 100 ohm resistor in series with the grid leak. The tuning dial should be set to midscale and the trimmer set to about 146 mc. plus 10.7 mc, or about 158 mc. This is best done with an absorption wavemeter, using

the dip in oscillator grid current as an indication of resonance. Then, couple the oscillator to the receiver through the coax cable. The oscillator coupling coil on the main chassis should then be tuned until the grid current meter on the oscillator dials. The coupling hairpin link should be adjusted until the oscillator grid current is about 75 percent of its no-load value. Tighter coupling than this will cause the oscillator to be unstable. Tuning the oscillator away from midscale should cause the grid current to rise slowly, and at either end of the dial it should be about 90 per-cent of its no-load value. Now, connect an antenna to the set; signals should be heard, if any stations are on. Tune in a weak signal and adjust the antenna trimmer for maximum quieting. This completes the receiver alignment.

The transmitter tuning is much simpler, requiring nothing but a 0-50 milliammeter. Plug in the oscillator-tripler tube, set the meter switch to read tripler grid current, press the test button, and resonate C_1 (Fig. 5) for maximum tripler grid current. This should be between 2 and 3 ma. Incidentally, a bakelite screwdriver or wrench should be used for these adjustments since the trimmers are returned to "B plus." Next, check the oscillator plate current. This should be about 10 ma. Switch the meter to the tripler plate and tune C_3 (Fig. 5) for a dip, about 10 ma. It would be a good idea to check this circuit with a wavemeter, to make sure that it is actually tripling and not doubling or quadrupling. Next, plug in the 7F8 amplifier tube, but disconnect its plate voltage lead from the terminal board.

Fig. 7. Schematic of the receiver oscillator.

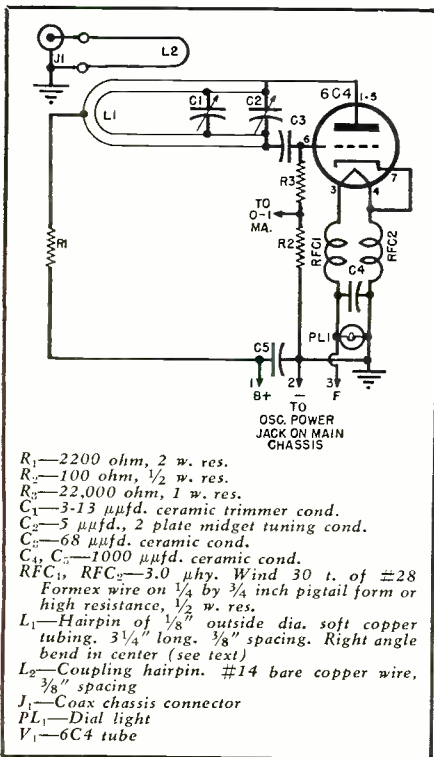

Here is exquisite high fidelity in chassis form that will grace the finest cabinet.

The 513 De Luxe Tuner is easy to install in any console cabinet, old or new and embodies the latest engineering refinements for lasting high quality at a price that defies competition.

The Espey 513 Tuner employs 10 tubes plus tuning indicator in a super heterodyne circuit and features a drift compensated circuit for high frequency stability, tuned RF on AM and FM plus phono input provision, and separate AM and FM antennas.

Model 514 De Luxe Power Supply-Audio Amplifier is designed specifically to work in conjunction with Model 513 Tuner, and is also used wherever a high quality audio amplifier is required.

With an output of 25 watts, Model 514 features a parallel push pull output circuit, self balance phase inverter system, extended range high fidelity response, and inverse feedback circuit.

Write Dept. KD for your free catalog.

ESPEY Makers of fine radios since 1928.
MANUFACTURING COMPANY INC.
 528 EAST 72nd STREET, NEW YORK 21, N. Y. • TEL. BUtterfield 8-2300

BARGAINS

KEY Code Practice TAC J-33. New. \$0.49
 TRANSFORMER—Kenyon Trans. Co., Primary 110 v. 60 cy., Sec. 5 v. @ 60 amp. C. T. 4.49
 CATHODE RAY TUBE—5CP7. 2.49
 DYNAMOTORS—101-C 2.95
 METERS—Westinghouse 0-150 v. A.C. 2 inch panel mount 2.95
 CIRCUIT BREAKER—Heineman Elec. 110 v., 60 cy. 5 amp. or 30 amp. Each.99

All C.O.D. orders to be accompanied by 25% deposit. Orders without postage will be shipped express collect. F.O.B. Berwyn, Md.

R. & T. ELECTRONICS COMPANY, Inc.
 9723 Baltimore Blvd.
 Berwyn, Maryland Phone TOWer 5384

AUTOMATIC M-90 AUTO RADIO

• Six Tube Superheterodyne • Three Gang Condenser • Powerful, Long-Distance Reception • Fits All Cars, Easy Installation
 • Mounting Brackets Included Net \$29.97
 • 6 Tube model M90 \$29.97
 • 5 Tube model X50 \$24.36

MAIL US YOUR ORDERS
 All orders filled within 24 hours. Illustrated parts list on request. Sylvania and Cunningham tubes 50% off list

Bill Sutton's Wholesale Electronics
 Fifth at Commerce Fort Worth, Texas

ARE YOU RECTIFIER-WISE? WIN A VALUABLE PRIZE

With your Circuit Designs Using Federal's
Miniature Selenium Rectifiers

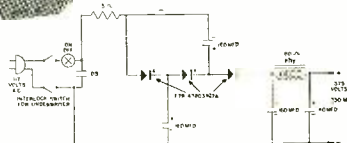

CONTEST DETAILS

1. All entries must be original circuits.
2. All entries become the property of Federal Telephone and Radio Corporation.
3. Federal engineers will judge entries on basis of novel and useful applications and select winning circuits.
4. Five winners will be selected from the entries received during each month of the contest. A grand prize will be awarded to the outstanding entry of the contest.
5. All entries must be received by the contest final closing date—July 31, 1949. Mail your entry to Contest Box B.
6. Winners will be announced.

Here is your opportunity to convert your circuit ingenuity into a useful and valuable prize. Federal, the originator of the Miniature Selenium Rectifier, is interested in your ideas on the use of this revolutionary circuit element.

A multitude of circuits have been built around the outstanding characteristics of Federal's complete line of Miniature Selenium Rectifiers—audio amplifiers, home radios, television receivers, 'ham' transmitters, FM adapters, phonograph amplifiers and many other electrical and electronic circuits. They all capitalize on the long life, high current capacity, instantaneous starting and great efficiency of these rectifiers. This compact, lightweight television power supply is typical.

These are but a few applications. The uses of these Miniature Rectifiers are almost unlimited. Get your idea down on paper and send it in today. It may be a prize winner!

FIVE MONTHLY PRIZES AND A GRAND PRIZE

The five monthly winners will each receive, FREE, a Federal FTR-1342-AS Selenium Rectifier Power Supply-Battery Charger. This compact unit, with its 6-volt, 6-ampere DC output, has many uses in home and shop. It comes equipped with a handy under-dash mounting socket for automobile battery charging.



The grand prize, a Federal FTR-3246-BS Radio Service Power Supply, is invaluable as a source of heavy duty, filtered DC power. Its 6-volt, 10-ampere DC output will handle auto radio testing and many other test and permanent power requirements. List price \$74.50.



MAIL YOUR ENTRY TO: MINIATURE RECTIFIER CONTEST
Federal Telephone and Radio Corporation

SELENIUM INTELIN DIV. • 900 PASSAIC AVENUE • EAST NEWARK, NEW JERSEY

Switch the meter to the amplifier grid circuit, press the test button and re-adjust the tripler plate tank for maximum grid current. This should be between 10 and 15 ma. Now, the amplifier must be neutralized. As the amplifier is tuned through resonance (no plate voltage on the amplifier, of course), the grid current will flicker slightly. Adjust the neutralizing condensers until this flicker disappears. This will probably occur with both neutralizing condensers near minimum capacity. When neutralization is completed, plate voltage may be applied to the amplifier. Recheck all previous tuning adjustments (except neutralizing), for maximum amplifier grid current, and switch the meter to the amplifier plate circuit. Tune C_s (Fig. 5) to minimum plate current, which should be about 15 ma. When the antenna is connected, the coupling link and C_{10} (Fig. 5) may be adjusted so that minimum plate current is 20-25 ma. The amplifier may be loaded more heavily than this, but it is not necessary, since the power increase will be small and tube life shortened. When a microphone is plugged in and the gain turned up the rig should modulate "upwards" and sound pretty good in a monitor. The complete rig is now ready to go.

Installation

There are as many possible installations as there are types of cars, and this rig is adaptable to all of them. It is also very well adapted to home station use.

Of course, the obvious and necessary place for the tuning unit is close by the operator, but the main unit may be placed almost anywhere. In a business coupé, the ideal place would be on the shelf behind the seat. In that case, an external speaker would not be necessary. In sedans, the best place is in the trunk, or possibly on the shelf behind the rear seat if there is room. One might ask, "But how are the controls to be manipulated?" The answer is that no manipulation is necessary. The transmitter, of course, is tuned up and forgotten, except for an occasional routine set of meter readings. The transmitter a.f. gain is set once and need not be readjusted. The receiver regeneration is set to its most sensitive point and forgotten. The only control which might need adjustment is the receiver volume control; but superregenerative detectors have almost perfect a.v.c. action, and you will be surprised at how little change is needed. If you still think you need one, an inexpensive attenuator may be placed in the remote speaker lead. The remote speaker may well be your car radio's speaker if it is a PM type with a 3 ohm voice coil, which most recent sets have.

Of course, a good antenna is essential for good results. The best type possible on a car is the quarter-wave ground-plane vertical, mounted on the center of the car's roof, which is the

SAVE

at **RADIONIC** the
House of Radio and Television Buys

- MAGNAVOX SPEAKER 12" PM. 8 ohm voice coil. Will handle 15 watts. Rare value! **\$4.70**
- MAGNAVOX SPEAKER 8" PM. 21 ohm slug 6-8 ohm voice coil. Remarkable fidelity. Genuine bargain! **\$3.15**
- TRANSFORMER RCA model. 720 VCT @ 160 ma., 6.3 VCT @ 4 amps., 5 V @ 3 amps. Shell type, universal mounting. Shpg. wt. 7 lbs. **\$2.95**
- FILTER CHOKE 4.5 Hy. @ 200 ma. Open frame mounting. RCA model. Companion piece to above transformer. **\$1.55**

TUBES Standard brands up to 80% off. Send for list. **TERMS:** 20% deposit with order, balance COD.

RADIONIC EQUIPMENT COMPANY

Tribune Theater Entrance
170P Nassau Street :: New York 7, N. Y.
Worth 2-0421 :: Open daily 9 to 6--Saturday 9-5

FREE! MAIL TODAY!

GET YOUR COPY AT ONCE!
of RADIONIC's Bargain Catalog, Radio & Television Sets—Parts—Accessories. Unbeatable Values!

RADIONIC EQUIPMENT CO., Dept. 57
170P Nassau Street, New York 7, N. Y.

Please rush Free Copy of your latest Bargain Catalog of Radio and Television Sets, Parts, Tubes and Accessories.

NAME.....
ADDRESS.....
CITY..... STATE.....

EMC Model 102 NEW POCKET VOLOMETER*

1000 OHMS PER VOLT METER... \$13⁹⁰

- 3" Square Meter
- 3 AC Current Ranges
- Round cornered, Bakelite, Molded Case

- Same Zero Adjustment for Both Resistance Ranges.

Specifications: 5 AC Voltage Ranges; 5 DC Voltage Ranges; 4 DC Current Ranges; 3 AC Current Ranges; 2 Resistance Ranges.

*Reg. trade mark for Volt-Ohm-Milliammeter
Write For Catalog A-7

EMC ELECTRONIC MEASUREMENTS CORP.

423 Broome St.
New York 13, N. Y.

ground plane. If the XYL objects to your boring holes in the top of the car, the antenna may be mounted with rubber suction cups available in any auto supply store. The lead-in may be either 52 ohm coax or two lengths of 75 ohm twin-lead connected in parallel. The latter actually works better since it more nearly matches the impedance of the antenna. Also, it is so thin that it may be jammed under the window, which cannot be done with coax, unless you don't object to drafts in cold weather. All cables carrying 6 volts should be of heavy wire, No. 14 or better, and where wires pass under the car chassis a good grade of insulation should be used.

Remarks

The rig gave remarkably little trouble in its construction and installation, and most circuits worked right off the bat. Only one trouble turned up: when the transmitter was first turned up we had a bad case of r.f. feedback to the audio system. Bypasses were tried here and there to no avail until a point was found right at one of the relay contacts that seemed to be causing all the trouble. This is shown as C₁₀ (Fig. 2) on the diagram. In another layout, this might be needed elsewhere or not needed at all. No parasitics or traces of instability turned up anywhere, which is quite remarkable in a rig built so compactly. QSO's have been had over distances of many miles while riding, and everyone worked has reported the signal clean and steady. All in all, quite an improvement over the v.h.f. mobile rig of another day.

ANOTHER USE FOR THAT RUBBER GROMMET

OFTEN, the alligator clips used to grip the antenna leads, storage battery leads, etc., do not hold as firmly as might be desired. A great help in keeping the clip tightly fastened is to slip a rubber grommet over its "jaws." Since the grommet fits snugly over the clip, the holding power is greatly increased, and there is no danger that the lead line will slip out of the clip.

BOSTON CHAPTER R.T.G.

FOLLOWING is a complete list of officers elected by the Radio Technicians' Guild, Boston Chapter, 394 Washington Street, Brookline 46, Mass.

President of the chapter is James Stine of 212 Massachusetts Ave., Arlington, Mass. Vice-president, treasurer, and secretary, respectively, are Melvin A. Shikes, 156 Harvard Ave., Allston, Mass.; Hyman Leve, 479-483 Cambridge St., Allston, Mass.; and Alfred T. Turner, 394 Washington St., Brookline 46, Mass.

Officers serving on the board of directors are, George Batt, 8 White Ave., Brookline, Mass.; Edmund E. Chebator, 26 Cedar St., No. Cambridge, Mass.; George I. Cutter, 179 Pleasant St., Malden, Mass.; and Herbert L. Gamer, 3145 Washington St., Jamaica Plain, Mass.

BUY COMET OUTSTANDING VALUES!

SPECIAL CLOSE-OUT

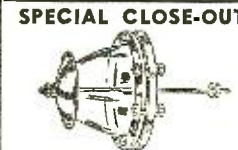

Navy Exterior Type Insulator with 3/4" x 1/2" Bowl Porcelain flanged bowl with Brass Rod and fitting and aluminum shield. Dimensions of Bowl, 4 3/8" High, 6 1/16" OD at Base. **\$3.50**

SPECIAL

TWIN CHART RECORDER
Esterline-Angus ANVT-N Twin Flush Type Graph-DC Milliammeter.
Scale Range-2.5-0-2.5
Feeds Hourly-3/4-1 1/2-3-6-12
Feeds Minute-3/4-1 1/2-3-6-12
Writing 4 or 5 Synchronous Clock on each meter, right hand and left hand chronograph pens-one on each meter complete with charts, ink, pen filler. **New, \$475.00**

TUBES

2C44	50.66	954	15
2 X 2A	.55	CK1005	.35
2 X 2/879	.55	1816	1.37
3C24	.38	1829	.25
3E29	4.35	2051	.40
15E	2.00	3BP1	1.35
15E	.85	5CP1	1.95
24C	.55	5HP4	2.90
39/44	.45	5FP7	1.00
45 SPEC.	.35	V7-127A	2.49
211	.35	1A5GT	.45
450TH	18.25	176G	1.10
3 EIMAC	19.50	2A3	1.00
531	3.75	3Q4	.55
80TH	10.00	6A5	.85
805	3.90	6H6	.35
807	1.15	6SG7	.65
815	1.15	6SH7	.45
826	4.45	12A6	.20
830B	5.00	6V6GT	.80
832A	1.35	251GGT	.55
872A	1.35	3Z5	.45

TIME DELAY SWITCHES

3 Sec. and 90 Sec. each spot 120V 10A Motor 120 VAC Cramer. Each, \$2.95

1 Minute 115 VAC 60 cy. Enc. in waterproof metal case, \$2.95.

3 Micro Switches make contact at 40-41-42 Sec. time delay 110VAC 60 cy. Motor, \$4.25.

Thermoswitch 100° F. to 300° F. 115 VAC 6A. 230 VAC 5A Breaks Contact with increase of temp. adj. 40° F. per 1° turn of adj. screw. Fenwall, .09.55.

PLUGS

PL-150 Plug for Dynamotor Socket on X-mitter BC-223. .39

PL-25 on 35" Cord. .18

2 PL-55 Plugs on 35" Cord. .18

JK-26 Jack Socket for PL-259 .39

SO-239 Socket for PL-259 Plug. .29

PL-259 Plug for SO-239 Socket. .25

DE ION LINE STARTER

DPST 115 V 60 cycle Westinghouse Type DN, Size O, Class 15-825.0. NEW. \$3.25.

SPECIALS

80.86 KC Crystal in Holder \$1.50

200 KC Crystal in Holder. 1.35

CD501A Cord Connects BC-654 generator. 1.59

Variable Condenser for BC-348Q. 2.50

Amphenol Cable Clamp 3057-12 1/2. .25

CD-604 Cord with PL-540 Plug and X-Former for HS30. .59

MN-26Y Radio Compass Receiver. 150-325KC 325KC-695KC 3.4-7.0 MC 28VDC Bendix Mfg. Co. New. \$34.50.

CAPACITORS

40 mfd	25 VDC	30	.25
4 mfd	50 VDC	35	.30
3X.1 mfd	400 VDC	25	.20
.25 mfd	600 VDC	25	.20
.5 mfd	600 VDC	30	.25
1 mfd	600 VDC	30	.25
2X.1 mfd	600 VDC	35	.30
.05 mfd	1000 VDC	55	.50
2X.1 mfd	1000 VDC	60	.55

OIL FILLED AND GE PYRANOL

5.5 mfd	400 VDC	35	.30
1 mfd	500 VDC	35	.30
2 mfd	600 VDC	35	.30
4 mfd	600 VDC	55	.50
4 mfd	600 VDC To be/Clamps	60	.55
6 mfd	600 VDC	65	.60
8 mfd	600 VDC	1.00	1.00
10 mfd	600 VDC	1.10	1.00
4 mfd	700 VDC	65	.60
5 mfd	1000 VDC	55	.50
2 mfd	1000 VDC	55	.50
5 mfd	2000 VDC	1.10	1.00
25 mfd	3000 VDC	1.85	1.60
.5 mfd	3000 VDC	2.00	1.75
1 mfd	7500 VDC	2.60	2.30
.0008 mfd	15000 VDC	6.95	5.50
.045 mfd	16,000 VDC	3.25	2.95
3X.1 mfd	90 V 60 cy.	4.50	4.25

PAPER

8-8 mfd	600 VDC To be Fil-termite	1.00	.90
3X8 mfd	600 VDC	1.45	1.25
8-8-4 mfd	650 VDC	1.45	1.25

ELECTROLYTIC

2500 mfd	3 VDC	.15	.10
500 mfd	200 VDC	1.00	.90
16 mfd	450 VDC	1.45	1.20

XMITTING MICA

1 mfd	1000 VDC	30	.25
02 mfd	2000 VDC	55	.50
006 mfd	3500 VDC	55	.50
.0015 mfd	5000 VDC	85	.80

CAT. No.

WIREWOUND	OHMS	WATTS	POTENTIOMETERS	PRICE
.089	100	2	TAPER BUSHING SHAFT	EACH TEN
.036B4	1000	2	1/2" x 3/8"	CHIC. TEL. \$0.25 \$0.20
.028B1	3000	2	1/2" x 1 1/8"	TREFZ. .25 .20
.096	7500	3	1/2" x 3/8"	CHIC. TEL. .25 .20
.023B2	10,000	3	1/2" x 1 1/8"	TREFZ. .30 .25
.063	20,000	3	1/2" x 1 1/8"	TREFZ. .30 .25
.005B10	25,000	3	1/2" x 3/8"	WIRT .30 .25
.025B3	15,000	4	1/2" x 1 1/8"	TREFZ. .30 .25
.028B5	15	25	1/2" x 1 1/8"	DEJUR. 45 .40
OHMITE	20	25	1/2" x 1 1/8"	OHMITE 45 .40
.207B2	25	25	1/2" x 1 1/8"	DEJUR. 45 .40
.N2017	100	25	1/2" x 1 1/8"	IRC .55 .50
.147B1	200	25	1/2" x 1 1/8"	DEJUR. .55 .50
OHMITE	500	25	1/2" x 1 1/8"	OHMITE .55 .50
.155B1	15,000	25	1/2" x 1 1/8"	DEJUR. 70 .65
.105	20,000	25	1/2" x 1 1/8"	DEJUR. 85 .80
OHMITE	800	50	1/2" x 1 1/8"	OHMITE 1.10 .95
.079	400/400	50	1/2" x 1 1/8"	DEJUR. 1.10 .95
OHMITE	15	75	1/2" x 1 1/8"	OHMITE 2.45 2.25
OHMITE	750	180	1/2" x 1 1/8"	OHMITE 3.80 3.25
HELIPOT	20,000	5	1/2" x 1 1/8"	DEJUR. 25 .20
CARBON 101	500	2	1/2" x 1 1/8"	GIBBS 4.50 4.00
.084	10,000	2	1/2" x 1 1/8"	SD AB .25 .20
.134B1	20,000	2	1/2" x 1 1/8"	SD AB .25 .20

TERMS: Mail orders promptly filled—all prices F.O.B. Boston, Mass. Send M.O. or check. Shipping charges sent C.O.D. Minimum order \$5.00. 25% deposit required with all orders.

SEND FOR OUR CATALOGUE NOW!

Inquiries from Dealers, Schools and Industrial Firms Invited

COMET ELECTRONIC SALES CO.

22 Washington St. Brighton 35, Mass.
BEacon 2-7863

AUDIO ENGINEERING SCHOOL

A practical Audio engineering course in Sound Fundamentals; DISC, FILM and MAGNETIC Recording; Transmission Measurements; Monitoring and Mixing. Laboratories contain Transmission Sets, Oscillators, Harmonic Analyzer, Distortion Sets, Intermodulation Analyzer and other equipment. Recording Studio assembling Broadcast Motion Picture and Commercial Sound Recording; H. M. TREMAINE, Pres.-Director. Approved for Veterans and Foreign Visas.

HOLLYWOOD SOUND INSTITUTE, Inc.
1040-N North Kenmore, Hollywood 27, Calif.

SCHEMATICS—CONVERSIONS FOR SURPLUS GEAR

PARTIAL LIST:

ARC-4 schematic, parts, cabling. . . . \$1.00

Another \$2.00 for 2-meter AC conversion with all specs, tune-up, color-coded wiring diagrams.

BC-375-E original schematic, tuning units, complete parts list, values, characteristics, circuit functions, plate and ant. currents. . \$2.00

BC-645 original and conversion. . . . \$1.00

ARC-5 schematics, all units. . . . \$2.00

SCR-522-A, AM, and C schematics, parts lists with circuit functions, explanation of differences, chart for xtal selection. . . . \$2.00

Please remit with order. We pay postage. Send stamped addressed envelope for comprehensive list, cross-indexed for BC and SCR. Add 25c for chart explaining code used in Army-Navy nomenclature.

R. E. GOODHEART 345 1/2 N. PALM DRIVE BEVERLY HILLS, CALIF.

RADIO and TELEVISION

Thorough Training in All Technical Phases

APPROVED FOR VETERANS

WEEKLY RATES DAYS—EVENINGS

RCA GRADUATES ARE IN DEMAND

For Free Catalog write Dept. RN-49

RCA INSTITUTES, Inc.

A Service of Radio Corporation of America

350 West 4th St., New York 14, N. Y.

NOW!
BUILD 15 RADIOS \$14.75
COMPLETE KIT ONLY.

ABSOLUTELY NO KNOWLEDGE OF RADIO NECESSARY

You Need No Additional Parts
 The **PROGRESSIVE RADIO KIT** is the Only Complete Kit. Operates on 110-120 Volts AC/DC

Contains everything you need. Instruction book, metal chassis, tubes, condensers, resistors and all other necessary radio parts. The 36-page Instruction Book, written by expert radio instructors and engineers, teaches you to build radios in a professional manner. The circuits are designed to provide excellent performance. Altogether, fifteen circuits are constructed, including 11 receivers, 1 audio amplifier and 3 transmitters.

SPECIAL OFFER—Electrical and Radio Tester sent absolutely FREE with each Progressive Radio Kit. Plus FREE Membership in the Progressive Radio Club. Entitles you to free expert advice and consultation service with licensed radio technicians. **ORDER YOUR KIT NOW!**

VACUUM TUBE VOLTMETER KIT
 A professional piece of test equipment you need for FM and TV. Attractive steel case. **\$23.95**
 FREE: Book on Advanced Servicing Techniques.

5" Oscilloscope Kit
 AM-FM TELEVISION
 An absolute "must" for today's radio-man. Input Impedance: 1 Meg. and 50 Mmfd. Tubes: 6X4, 6X5, 6X6, 6X8, 6X9, 6X10, 6X11, 6X12, 6X13, 6X14, 6X15, 6X16, 6X17, 6X18, 6X19, 6X20, 6X21, 6X22, 6X23, 6X24, 6X25, 6X26, 6X27, 6X28, 6X29, 6X30, 6X31, 6X32, 6X33, 6X34, 6X35, 6X36, 6X37, 6X38, 6X39, 6X40, 6X41, 6X42, 6X43, 6X44, 6X45, 6X46, 6X47, 6X48, 6X49, 6X50, 6X51, 6X52, 6X53, 6X54, 6X55, 6X56, 6X57, 6X58, 6X59, 6X60, 6X61, 6X62, 6X63, 6X64, 6X65, 6X66, 6X67, 6X68, 6X69, 6X70, 6X71, 6X72, 6X73, 6X74, 6X75, 6X76, 6X77, 6X78, 6X79, 6X80, 6X81, 6X82, 6X83, 6X84, 6X85, 6X86, 6X87, 6X88, 6X89, 6X90, 6X91, 6X92, 6X93, 6X94, 6X95, 6X96, 6X97, 6X98, 6X99, 6X100. **\$39.95**
 FREE: Book on Cathode Ray Oscilloscope

Volt-Ohm-Milliammeter Kit
 simple to construct, inexpensive but accurate. FREE: Book on Elementary Radio Servicing. **\$14.95**

SIGNAL TRACER KIT
 an invaluable aid in troubleshooting. FREE: Book on Radio Test Instruments. **\$21.95**

7"-10" TELEVISION KITS
 Factory-built and aligned 13 channel Tuner—18 Tube Kit—7" Kit. **\$59.50**
 Complete set of tubes, including Cathode Ray Tube. **\$41.58**
 Factory-built and aligned 13 channel Tuner—10" kit, less tubes. **\$82.99**
 Complete set of tubes, including Cathode Ray Tube. **\$55.80**
 Cabinet for 7" or 10" kit. **\$24.50**
 FREE: Television Servicing Notes.

AMPLIFIER KIT
 High Fidelity Humless Amplifier complete with five tubes and two selenium rectifiers. **\$16.00**
 FREE: Book on Amplifiers.

TV SWEEP GENERATOR KIT.....**\$28.95**
 Range—2 Mc.-26 Mc.

SIGNAL GENERATOR KIT.....**\$18.95**
 150 Kc.-34 Mc. Fundamental.
 35 Mc.-100 Mc. Harmonics.

RF SIGNAL TRACER PROBE KIT.....**\$5.50**
 20 cycles—200 Mc. IN34 Xtal.

ECONOMY AMPLIFIER KIT.....**\$5.95**
 simple to build; complete with five tubes. FREE: Book on Amplifiers.

5 TUBE AC-DC SUPERHET KIT.....**\$14.25**
 complete with tubes and cabinet. FREE: Book on Building Receivers.

6 TUBE AC-DC 2-BAND SUPERHET KIT.....**\$17.45**
 complete with tubes and cabinet. FREE: Book on Amateur Radio Building.

7-TUBE AC-DC FM RECEIVER KIT.....**\$29.95**
 complete with tubes and cabinet. FREE: Television and FM Servicing Notes.

4 TUBE SUPERHET PORTABLE KIT.....**\$12.95**
 complete with tubes and cabinet, less batteries. FREE: Book on Unusual Radio Circuits.

Automatic Bike Radio
 Can be mounted on a bicycle, or carried as a personal portable radio. Supplied with all bicycle mounting hardware and telescopic antenna. Anti-theft feature. Less batteries. **\$17.47**

Automatic Car Radio
 6 tubes superhet. Three gang condenser, fits all cars. easy installation. mounting brackets included. List price \$39.95. **\$27.97**
 NOW ONLY: **\$25.97**
 Also 3 tube Superhet ONLY.....

Deduct 2% if full payment accompanies order. C.O.D. orders accepted in U.S.A. Write for further information concerning the above merchandise. Send for our Free catalog.

PROGRESSIVE ELECTRONICS CO.
 Dept. RN-23, 497 Union Avenue
 BROOKLYN 11, NEW YORK

AFCA NEWS

ARMED FORCES COMMUNICATIONS ASSOCIATION

This Association is a patriotic non-profit organization, with chapters in most of the larger cities, dedicated to developing and maintaining efficient personnel, commissioned, enlisted, civilian, for the supply (including design and development), installation, maintenance and operation of communications and electronic equipment for Army, Navy and Air Force and their supporting civilian activities. It publishes a magazine "SIGNALS" at its national headquarters in Washington. Every American interested in any way in communications is eligible and invited to join. Further details may be obtained by addressing the secretary at 1624 Eye St. N.W., Washington 6, D. C.

AFCA CHAPTER NOTES

Atlanta
 On April 18th, the officers and directors of the chapter met at a luncheon at the Athletic Club to hear Brig. Gen. S. H. Sherrill, AFCA National Executive Director, describe the activities at the third annual meeting in Washington in March. Chapter President Dan McKeever presided and introduced Maj. Gen. E. W. Smith, commander of the 108th Airborne Division, Organized Reserves; W. H. Mansfield, AFCA area representative and asst. vice-pres. of Southern Bell T & T; James Bonner, genl. sales mgr., Southern Bell; and Col. Charles Olin, Signal Officer Third Army.

At the regular meeting on May 11th, Maj. Gen. F. L. Ankenbrandt, Director of Air Force Communications, was the honor guest of the chapter together with Col. George W. Goddard, Air Force photography expert, who demonstrated the three-dimension color strip photography that featured the 1948 AFCA meeting at Wright Field.

Augusta—Camp Gordon
 The charter for this new chapter—the 33rd—was formally presented by Brig. Gen. S. H. Sherrill, National Executive Director, at the chapter's first organized meeting, April 19th, at the Officers' Club, Camp Gordon. Col. Harold Osborne presided. He introduced Maj. Gen. Spencer B. Akin, Chief Signal Officer of the Army, who spoke briefly about AFCA and its objectives, especially as a means of further unifying the communications activities in the three services.

The following were chosen as interim officers of the chapter: honorary president—M. S. Symms, Southern Bell T & T Co.; president—H. A. Fleming, Southern Bell T & T Co.; vice-president—F. A. Saxon, Georgia Power Company; honorary secretary-treasurer—Maj. Norman L. Kinley, Camp Gordon; secretary-treasurer—

Maj. Nell Farnham, Camp Gordon. It was decided to hold meetings at 7:30 p.m. on the third Wednesday of each month, alternating between Augusta and Camp Gordon.

Chicago
 The Chicago chapter held a meeting on May 20th for the purpose of reorganizing and planning chapter activities. Oliver Read, chapter president, and T. S. Gary, AFCA National Director in charge of chapters, arranged the meeting. Speakers included Admiral Earl E. Stone, Chief of Naval Communications; Fred R. Lack, president-elect of AFCA and vice-president of Western Electric Co. and Brig. Gen. S. H. Sherrill.

Detroit
 An organizational meeting to establish a chapter in Detroit was held on May 19th. Some fifty representatives of communications and photography were present, including officials from Selfridge Field, the local radio stations, General Motors, Ford Motor Co., Western Union, and the Michigan Bell Telephone Co. Mr. George T. Jeffers, district commercial supt. of Michigan Bell, made the arrangements for the meeting. Brig. Gen. S. H. Sherrill, AFCA Executive Director, came from Washington to outline the procedures to follow in establishing the chapter.

European
 The Spring convention of the European Chapter was held in Frankfurt on April 30th. The guest speaker was Maj. Gen. R. W. Douglas, Jr., Air Force Chief of Staff, USAFE. He congratulated the chapter on its activities under the severe handicaps which exist in the European Theater. He stated that thirty per-cent of the Air Force was engaged in communications work and described the communications systems in use in the European Theater.

After reports from the various committees and sub-chapters, the annual election of officers was held. The result was as follows: president—Martin M. Newcomer, representative of The Western Union Telegraph Co. in Germany; vice-president—Lt. Col. Steve J. Gadler, USAFE, Chief, Electronic Supply; executive secretary—Chase E. Laurendine, retiring chapter president, Communications Group, Bipartite Control office, Frankfurt; treasurer—Capt. Winston Williams, OIC, Communications Center, ASA, Frankfurt; counsel—Lt. Col. R. W. White, Administrative Officer, OC-SigO, Heidelberg.

At the conclusion of the meeting,

the members participated in two scheduled tours—one to the Rhein-Main to see the GCA, and the other to the air traffic control center in Frankfurt.

Kentucky

The Kentucky Chapter is the winner of the second annual "Chapter of the Year" contest. A special scroll for "excellence in activities, in interest and initiative, and in contribution toward the objectives of the association" will be presented to the chapter at its next meeting by T. S. Gary, AFCA National Director in charge of chapters.

New York

The program for the April meeting, held at the Seventh Regiment Armory on April 28, was sponsored by the Air Force members of the chapter. Due to unforeseen circumstances, General Gordon Saville, Commanding General of the Air Force Defense Command at Mitchell Field, who had been scheduled to speak, was detained in Washington and could not be present. Col. Hobart Yeager, director of communications and electronics of the Continental Air Command, acted as "pinch-hitter" for General Saville and gave a very interesting description of the organization of the Command and its communications problems. He also presented an unusual motion picture dealing with atomic energy, called "God and the Atomic Bomb."

Col. John A. Hartman, USAFR, then discussed the plans and functions of AFCA as applied to the Air Force membership and urged all eligible personnel to join the New York chapter. Mr. Fred R. Lack, president-elect of AFCA, and vice-president of *Western Electric Co.*, followed with an informal talk on the events of the recent annual AFCA convention in Washington.

Philadelphia

The Philadelphia chapter has launched a campaign to bring about greater understanding and cooperation between members of the armed forces and the communications industry in its area. The first of a series of meetings in line with this objective was held on April 19th at the Philadelphia Navy Yard. More than fifty persons attended a dinner at the Officers' Club and then toured the Navy Yard to inspect shipboard communications equipment.

Pittsburgh

The regular monthly meeting of the chapter was held on April 12th in the Auditorium of the *Bell Telephone Building*. Further consideration was given to problems submitted by the AFCA National Advisory Committee. Subjects and discussion leaders were: "Reduction of Time between Experimental and Production Models of Communications Equipment"—E. N. Wells, *Bell Telephone Co. of Pa.*; "Evaluation of Production Capacity by a Unit other than the Dollar"—C. A.

July, 1949



Become an **ELECTRICAL ENGINEER**

MAJOR IN ELECTRONICS

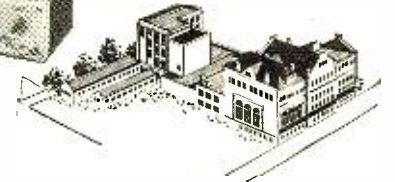

B. S. Degree . . . in 36 months

Make one of the most important decisions of your life—today! Capitalize on your electronic interests—decide to become an **Electrical Engineer**. Choose, also, to save a valuable year by earning your Bachelor of Science Degree here in 36 months of intensive study.

This 46-year-old, non-profit Technical Institute offers a world-famous course in Electrical Engineering with a major in **Electronics**. You follow an industry-guided program which is constantly attuned to current developments. It presents a solid background in the basic sciences . . . Chemistry, Physics, Mathematics, Economics and Electrical Engineering subjects . . . plus 19 technical specialty courses in Engineering Electronics, including four courses in Electronic Design.

Practical, military or academic training will be evaluated for advanced credit.

ELECTRONIC TECHNICIAN

At the end of the first year of study of the Electrical Engineering course, the student is qualified as an Electronic Technician.

RADIO-TELEVISION TECHNICIAN

To young men interested specifically in radio and television: Prepare here for a career in television—the field which business leaders predict will be among America's top ten industries by 1951. In 18 months you become a Radio-Television Technician, ready for positions in receiver and transmitter testing, servicing, sales, supervision and production. Because of this school's **concentric curriculum**, the Bachelor of Science degree in Electrical Engineering (Electronics major) may be earned in 24 additional months.

A SPECIAL PREPARATORY PROGRAM is offered for men lacking high school diplomas.

TRAIN in modern, well-equipped laboratories, shops and classrooms. Faculty of 85 specialists—over 1500 students and 30,000 graduates.



FALL TERM OPENS OCT. 3

- Electrical Engineering36 months
Electronics Major
- Electronic Technician12 months
- Radio-Television Technician18 months

MILWAUKEE SCHOOL OF ENGINEERING

Founded 1903 by Oscar Werwath

Send Coupon for free 48-page Pictorial Bulletin, "Your Career," and 110-page Catalog.



MILWAUKEE SCHOOL OF ENGINEERING

Dept. RN-749, N. Broadway and E. State, Milwaukee, Wis.

Without obligation send me the Bulletin, "Your Career," and your catalog.

I am interested in _____ course.

NAME AGE

ADDRESS

CITY STATE Veteran of World War II

TUNING UNITS from BC-375



T.U.-6-7-9-10-26

Without Covers used in VERY GOOD CONDITION

\$149 ea.

AT-49/Apr4 RADAR ANT.
New radar dome type antenna with mounting base and connection in original carton.

\$239 ea.

Control Box from SCR-522 BC-602-A & BC-602-D



69¢ each New

We Have Hundreds of Surplus Radio Items
"Send Us Your Inquiries"
Do Not Include Postage. We Will Send Postage Collect

7201 E. Marginal Way SEATTLE 8, WASH.

"STERNOFF'S HAM SHACK"

Phone: LAndeR 8100

Sun Radio's Annual Clearance!

CRYSTALS! All crystals have Army MC harmonic ratings but Sun encloses directions for deriving the correct fundamental frequency in kilocycles.

JUST ARRIVED—NEW FREQUENCY CRYSTALS FOR HAM & GENERAL USE
FT-243 holders, 1/2" pin spacing, fractions omitted.

GENERAL USE				HAM USE			
2-6-10-11-20-40 METERS							
6006	6773	7840		5305	5840	6000	6573
6040	6873	7873		5677	5873	6273	6606
6073	6906	7906		5706	5875	6340	6640
6106	6940	7940		5725	5900	6373	6673
6140	6973	7973		5740	5906	6406	6706
6150	7740	8240		5760	5925	6440	6740
6206	7773	8273		5773	5940	6506	6806
6208	7806	8306		5806	5973	6540	7040
							7473
							8340

49c EACH 10 for \$4.50 **99c EACH** 10 for \$9.00

CRYSTALS WITH A MILLION USES

Fractions		Omitted	
412	422	433	442
413	423	434	443
414	424	435	444
415	425	436	445
416	426	437	446
418	427	438	447
419	429	440	448
420	431	441	451

49c each

Crystal Frequency Standards	For Crystal Controlled Signal Generators
98.356Kc	525Kc
Easily altered for 100Kc Standard. Mounted in low loss & prong holder.	
\$3.89 each	99c each

I.F. Frequency Standards	200 KC CRYSTALS
450 kc	Without Holders
451.388	2 1/2" x 2 1/2". Each
452.777	3 for \$2.00
461.111	
464.815	
465.277	

99c each

Assorted Miscellaneous Crystals	For Ham and General Use
Fractions Omitted	Fractions Omitted
370Kc	390Kc
372Kc	396Kc
374Kc	403Kc
375Kc	408Kc
376Kc	391Kc
377Kc	397Kc
378Kc	398Kc
379Kc	404Kc
380Kc	405Kc
381Kc	407Kc
382Kc	401Kc
383Kc	407Kc
384Kc	395Kc
385Kc	386Kc
386Kc	388Kc
387Kc	391Kc
388Kc	392Kc
389Kc	393Kc
390Kc	394Kc
391Kc	395Kc
392Kc	396Kc
393Kc	400Kc
394Kc	401Kc
395Kc	402Kc

39c each **79c each**

CRYSTALS FOR SCR 522	CRYSTALS FOR HAM USE	Crystals from BC 6 10 Spacing—2 Banana Plugs
5910Kc	7480	2045
6370	7580	2305
6450	7810	2105
6510	7850	2125
7350	7930	2145
		2155
		2220
		2258
		2260
		2282
		2300
		2305
		2320
		2325
		2337
		2390
		3250
		3294
		3322
		3322
		3355
		3510
		3595
		3520

\$1.29 each **\$1.29 Each**

* Payments must accompany order. Enclose 20c for postage and handling. Minimum order—\$2.00 plus postage.
Crystals are shipped packed in cloth bags inasmuch as they are shock mounted. All shipments guaranteed.

- Transcription Turntable, Broadcast quality, 16" weighted turntable, 33 1/3 & 78 RPM, famous make De-luxe model, Reg. \$155.00 net... only \$110.00
- Professional Recording Turntable, 16", 33 1/3 & 78 RPM, Aluminum alloy casting table, famous make, Reg. \$165.44 net... only \$118.00
- Eastern Musical Instrument Amplifier, 2 inputs, Reg. \$65.00, reduced to \$24.95
- Regal Talkfone, 20 watt PA amplifier, Reg. \$65.00, reduced to \$24.95
- Vision FM Teletuner, tunes in FM-88-108 mc on your TV receiver, attaches to antenna... only \$12.49 Reg. \$17.97
- Record Changer—Automatic, General Instrument, new... only \$10.88
- Long Playing Record Player—33 1/3 RPM on wood base, with LP arm and permanent needle new reduced to \$9.88
- Scope TV Antennas
- Ward TVM-9, Hi-Lo folded dipoles with reflectors, 10 foot mast, Reg. \$26.50... now \$9.90

© TERMS: All items F.O.B., Washington, D. C. All orders \$30.00 or less, cash with order. Above \$30.00, 25 per cent with order, balance C.O.D. Foreign orders cash with orders, plus exchange rate.

SUN RADIO
OF WASHINGTON, D. C.
938 F STREET, N. W. WASH. 4. D. C.

McKenney, Jr., Peoples First National Bank & Trust Co.

Mr. D. L. Chaffee, engineer, Copper-weld Steel Company, reviewed the AFCA annual meeting held in Washington.

Richmond

The Richmond Chapter wound up its activities for the season with a dinner meeting at Ewart's Cafeteria on April 26th. Photography was the theme of the evening's program. Mr. G. Alexander Roberson, chairman of the Photographic Committee of the National Speleological Society, was the guest speaker and gave an illustrated talk on "Spelunking (Cave Exploring) as a Hobby."

Seattle

Forty-one members attended the April 12th meeting at the American Legion Hall. President Maurice Kerr discussed the campaign being conducted to publicize AFCA and increase its membership in the Seattle area.

Mr. Marshall B. James of Northwestern Agencies spoke on the many uses of titanium and the important place this metal will take in the world markets in the next few years. A technical lecture was given by Maj. F. J. Werthmann, covering diversity receivers, frequency shift circuits, filters, multiplex mixer amplifiers, triple diversity, teletype circuits and use of keying c.w. on voice transmissions.

South Carolina

At a dinner meeting at the Fort Jackson Officers' Club on April 20th the foundation was laid for AFCA's newest chapter—known as the South Carolina Chapter. Arrangements were made by Col. Fred Fister of the South Carolina division of the Southern Bell T & T Co. Over one hundred were present, with a large delegation from Charleston, headed by Capt. R. E. Melling, USN, Naval District communications officer; and a group from the Greenville Air Force Base headed by Lt. L. W. Lansdowne.

The honor guest was Maj. Gen. G. H. Decker, Commanding General of the 5th Division and Fort Jackson, who spoke briefly of his experience with communications and his opinion of AFCA's mission as an instrument of military preparedness. Mr. Ralph S. Grist of Atlanta represented AFCA's area representative Wm. H. Mansfield and discussed the progress made in establishing chapters in the South. He then introduced Brig. Gen. S. H. Sherrill, national executive director, who had come from Washington to describe the activities and purposes of the association and the procedures to follow in forming a chapter.

The following were chosen as interim officers to take immediate action toward increasing the chapter's membership and organizing committees to plan a worthwhile program of activities: president—J. M. McAlister, Southern Bell, Charleston; vice-presidents—J. L. H. Young, Southern Bell,

Charleston; Capt. R. E. Melling, USN, Charleston; Lt. L. W. Lansdowne, Greenville Air Force Base; secretary—Lt. George A. Frakas, Fort Jackson.

Southern California

The March meeting was addressed by Dr. I. H. Swift of the Naval Ordnance Test Station at Inyokern. He gave the audience an excellent picture of how analog computers operate and demonstrated them in the form of two simulated airplanes, in one of which was a simulated gunsight.

Lt. Col. H. W. O. Kinnard, USA, director of the Airborne Service Test Section of Army Field Forces Board #1, Fort Bragg, N. C., addressed the May 12th meeting on "Airborne Operations, Past, Present and Future." Col. Kinnard was well qualified to present this subject. During the war, he was a member of the 101st Airborne Division, and since that time has been one of the group principally responsible for developments in this field. He is temporarily stationed in Los Angeles as technical advisor on a motion picture pertaining to airborne operations.

Spanish War Veterans Division

The 49th annual reunion of the Spanish War Division of the U. S. Veteran Signal Corps Association, which is also an honorary chapter of AFCA, was held at the Hotel Victoria in New York on April 30th. Col. George P. Dixon, President of AFCA's New York Chapter, represented the Association at the luncheon and extended the best wishes of National Headquarters.

PAMPHLET HOLDERS

BY HARRY AICHNER

DO you have a dozen or so small booklets (camera manuals, address books, data sheets, instruction pamphlets, etc.) with no place to call "home"?

To keep these easily misplaced booklets where you can always find them, get a small cardboard carton, about 3 by 4 by 5 inches or so, and "file" your material therein.

A box that came with a 10-watt radio output transformer served the purpose excellently in one instance, but anything of suitable size will do, of course.

This makes a neat, compact container—one that keeps desk drawers from getting cluttered up with "little" things, while saving you the frustration of wondering "Where on earth is that book of formulas now?"



Spot Radio News
(Continued from page 16)

broadcast them for pickup at experimental receiving points.

Just how many receivers will be in operation, or whether the receivers will be purely experimental or actually commercial models, designed for future marketing, is not known at this writing. There have been reports that the receivers may be production run models and even offered for sale in the Bridgeport area. Standard receivers with converters, which proved so effective in the Washington tests, will also be used during these studies.

FM SPRANG INTO THE NATIONAL headlines recently as the result of two addresses, one in Columbus, Ohio, and the other in Washington.

During the Columbus talk at the Ohio State University meeting of the *Institute for Education by Radio*, Leonard H. Marks, Washington general counsel for the FM Association, bluntly asked FCC Chairman Wayne Coy for official action clarifying the future status of FM broadcasting, accentuating the fact that for eighteen months, the FM industry has been beset with problems resulting from indecision on part of the Commission.

The association counsel was extremely critical of the delays encountered by FM broadcasters in applying for construction permits for new FM stations.

"There was a time," he said, "when FM applications were acted upon within sixty to ninety days after they were filed. That day has unfortunately passed. Frequently a simple application for FM facilities will take eight months to be considered. During that time the applicant's interest will naturally wane."

A few days later Rep. Francis E. Walter addressed the House on the tardy progress of FM, declaring that . . . "FM has been obstructed, stepped on, blocked, or ignored from the start."

The representative declared that as a result of his talk, during which he said that the FCC has been guilty of an "appallingly flagrant disservice to the nation's progress by its hurtful impeding of FM," his mail was not only voluminous, but startling. Accordingly, the congressman has asked for an investigation of alleged violations by the FCC of the Federal Administrative Procedures Act.

Describing his motive for the query, Walter said: "It is a basic declaration of the Administrative Procedures Act that every agency shall proceed with reasonable dispatch to conclude any matter presented to it, and this has been obviously disregarded by the Commission."

FCC RECEIVED another verbal drubbing from Senator Edward John-

July, 1949

Radio Men
WHO ARE CRITICAL
RELY ON **W L**
RELAYS · RESISTORS

You have the fullest assurance against failures and breakdowns . . . you get long-life accuracy and stability . . . when you install Ward Leonard current controls. That's proved by performance in countless applications . . . under the most severe operating conditions. And that's why Ward Leonard Relays and Resistors are standard with so many control engineers . . . and with radio amateurs, too. You will find an economical answer to your needs in the wide range of stock types and sizes . . . at your Ward Leonard Distributor.

Radio and Electronic Distributor Division
WARD LEONARD ELECTRIC CO.
53-N West Jackson Blvd., Chicago 4, Ill.

Basic 3R's in Current Control
WARD LEONARD
RELAYS · RESISTORS · RHEOSTATS
REGISTERED ENGINEER **W L** CONTROL DEVICES

Send for
CATALOG D-130
Gives helpful information and data on relays, resistors and rheostats. Lists the many stock types.

RADIO ENGINEERING 27 MONTHS DEGREE IN
Intensive, specialized course, including strong basis in mathematics and electrical engineering, advanced Radio Theory and Design, Modern laboratory. Low tuition. Self-help opportunities. Also 27-month courses in Aeronautical, Chemical, Civil, Electrical and Mechanical Engineering. Gov't approved for G.I.'s. Enter Sept., Dec., March, June. Catalogue.
INDIANA TECHNICAL COLLEGE
979 E. Washington Blvd., Fort Wayne 2, Indiana

TINY RADIO!
Red plastic case. No tubes, batteries or electric "plugs" needed! Guaranteed to receive local stations. Only \$3.99 (ok. Mo. cash) postpaid or send only \$1.00 and pay \$2.99 C.O.D. Complete ready to play on easy connection. With Personal phone. Get your tiny radio now!
MIDWAY SALES CO., DEPT. TRN-7, KEARNEY, NEBR.

GOVERNMENT SURPLUS! WORLD'S LOWEST PRICE
PHOTO FLASH EQUIPMENT
COMES COMPLETE WITH
4 EDGERTON FLASH TUBES & REFLECTORS
EASY TO CONVERT INTO A 2-WAY PHOTO FLASH UNIT
OPERATES ON 110V. AC & 12V. BATTERY
Brand new at a fraction of original cost. Contains finest component parts available. All necessary parts and complete instructions included. After conversion, works on 110V AC or 12V battery by a flick of a switch.
\$68. COMPLETE
IMMEDIATE DELIVERY ON ALL MAIL ORDERS
CINEX, INC., 165 W. 46th St., N. Y. 19, N. Y., Dept. RN-7

HELLO AND GOOD BUYS

2" GE 0-200 MICROAMPS
Model DW51 Panel Meter.....each \$4.50

ADVANCE ANTENNA RELAY
110 Volt 60 Cy. coil. Ceramic insulation.
DPDT.....\$1.95

VIBROPACK

6.3 Volt input—output 300 Volt @ 100 ma.
Complete only.....each \$8.95

VIBRATOR TRANSFORMER & Type 534C
Synchronous Vibrator as used in above. Both
for.....\$5.95

GENERAL PURPOSE TRANSFORMER

Ideal for Bias, Filament, Isolation, Stepdown,
etc., 2 isolated 110v pr. sec. 110v at 900 ma plus
6.3 @ 2 amp. Fully cased.....Now each \$1.49

STANDARD "METERS" BRAND NEW

2" 0-5 ma Basic.....\$1.95	3" 0-50 amps AC.....\$4.95
2" 0-3 volts DC.....2.45	3" 0-100 ma.....3.50
2" 150-0-150.....	3" 0-50 amp AC.....2.95
microamp.....3.49	3" 0-75 amp AC.....3.95
2" 0-30 amp DC.....2.45	3" 0-2 ma DC.....3.95
2" 0-1 ma Basic.....2.95	3" 0-200 ma DC.....3.95
2" 0-20 ma Basic.....1.75	3" 0-1 ma DC.....3.95
2" 0-500 ma.....1.95	3" 0-20 ma DC.....3.50
2" 0-10V. AC.....2.50	3" 0-15 ma DC.....3.95
2" 0-30 V. DC.....2.50	3" 0-150 V. AC.....3.95
2" 0-1 amp R.F.....2.45	

OIL CONDENSERS

20 mfd 330 vdc.....\$1.85	15 mfd 1000 vdc.....\$2.95
1 mfd 600 vdc......29	2 mfd 1500 vdc.....1.25
2 mfd 600 vdc......39	6 mfd 1500 vdc.....2.95
4 mfd 600 vdc......59	1 mfd 2000 vdc.....1.45
6 mfd 600 vdc......79	2 mfd 2000 vdc.....2.25
3/3 mfd 600 vdc......79	4 mfd 2000 vdc.....3.65
10 mfd 600 vdc......95	6 mfd 2000 vdc.....3.95
2 mfd 1000 vdc......79	2 mfd 4000 vdc.....5.50
4 mfd 1000 vdc......95	1 mfd 5000 vdc.....3.95

CHOKE BARGAINS

6 Henry 50 ma 300 ohms.....	3 for \$0.99
8 Henry 80 ma 230 ohms.....	2 for .99
8 Henry 160 ma 140 ohms.....	1 for .99
1.5 Henry 250 ma 72 ohms.....	.59
14 Henry 250 ma 140 ohms.....	3.75
6 Henry 300 ma 65 ohms.....	3.75
4.3 Henry 620 ma 42 ohms.....	6.95
Swing Choke 1.6/12 Henry 1 Amp/100	24.50
ma 15 ohm.....	
.07 Henry 7 amps .5 ohm.....	4.50

PLATE AND FIL. Transf. Pri. 110 V 60 Cy. Sec.
1120 V CT @ 600 MA. 6.3 V @ 3A. 2x5V @
6A.....each \$9.95

UTC type PA 5000 ohm plate to 500 ohm line and
6 ohm voice coil. 10 watts, 60 to 10,000 cps ± 1
DB. GREAT VALUE.....each \$2.75

THORDARSON PLATE TRANSF. 2370 volts
CT at 250 MA tapped at 300-0-300 volts, plus 215
volt 55 MA bias winding. 110 volt 60 cy. pri.
Fully shielded.....each \$11.95

AMERTRAN PLATE TRANSFORMER 1500-
1250-0-1250-1500 Volts at 1.5 amps. Continuous
Duty. Pri. 110/220 V. 60 cycles. Fully Cased.
5 KV insulation.....\$39.95

HIGH CURRENT TRANSF. 820 Volts CT at 775
Ma. Pri. 110/220 Volts 60 cycles. Fully Cased.
Weight 35 lbs.....\$6.95

FILAMENT TRANSFORMERS

110 Volt 60 cy Pri. Fully Cased 6.3 volts	1.89
10 Amps.....	
5 Volts 15 AMPS.....	3.75
2.5 Volts 10 Amps.....	4.95
2.5 Volts Ct 21 Amps.....	4.95

MULTI-SECONDARIES

5 1/2 V Ct 21 Amp. 7.5V 6A. 7.5V 6A.....	\$5.95
6.5V 21 Amp. 6.3V 2A. 2.5V 2A.....	3.95
5 Volts 4A. 6.3 Volts 3A.....	2.50
2.5V Ct 20 Amps. 2.5V Ct 20A.....	4.50
2.5V Ct 10A. 6.3V 1A. 5V 3A. 5V 3A.....	4.50

SOLA CONST. VOLTAGE TRANS. Pri. 95-125V.
60 Cy. Sec. 115V. reg., 120 V.A.....each \$16.50

DUNCO RELAY SPDT 6 Volt 60 cycle coil \$1.39

30-WATT WIRE-WOUND RESISTORS

Ohms: 100-150-1500-2500-3k-4k-4500-5k-5300-
10k-15k-18k-40k.....each 15c 8 for 99c

AMERTRAN H. V. PLATE TRANSF. 1500-0-
1500 volts 600 MA Pri. 110/220 V 60 cycles. Con-
tinuous Duty. Fully Cased. 3 KV insulation.
Limited Quantity.....\$19.95

POWER TRANSFORMER

110 Volts 60 Cy Pri.-Sec. 700V. CT @ 125 ma
5 volts 3 amps, 6.3 volts @ 2.1 amps.....\$2.75

.004 1000 VDC Micas.....	10 for \$0.99
.01 600 VDC Micas.....	10 for .99
1000 mfd 25 VDC Electrolytics.....	3 for .99
2 Meg. 1/2 1% Meter Multipl. IRC.....	1 for 1.95
25 Ma. Littelfuses.....	1 for .99
ERIE .0005 Ceramicos.....	15 for .99
C-D 1 Mfd 400 VDC Oil Tubulars.....	10 for .99
.0015 5% Silver Micas.....	10 for .99
JAN 6C4 Tubes. New Boxed.....	4 for .99
Heineman 5 Amp 110V AC CKT BRKR.....	1 for .99
Heineman 25 Amp 110V AC CKT BRKR.....	1 for 2.99
2 Mfd 250 VAC Condensers.....	6 for .99
TRIMM "Commercial" Head Phones.....	3 for 7.50
10 Meg 10 Watt Resistor.....	.59
.02-400 VDC Tubulars.....	15 for .99
Allied DPDT 24 VDC Relays.....	1 for .99
MU Switch with Roller SPST 15A 110VAC.....	.39
C-H Toggle DPST 20 Amp 250VAC.....	.85

If not rated, 25% with order, balance C.O.D.
Minimum order \$3.00.

PEAK ELECTRONICS CO.

188 WASHINGTON STREET, DEPT. MR
NEW YORK 7, N. Y.

son, author of the proposed Johnson bill, which would hold power to 50 kw. He ripped into every department in the Commission, charging that... "the bewildered commissioners bogged down in the technicalities and red tape of their own creation."

The senator slammed hard against the clear-channel proposals favored by the FCC which would give clear-channel stations authority to boost their power to 500,000 watts. Such action, he said, would concentrate control of the industry in three or four New York and Chicago corporations and ten to fifteen major stations. He felt that Congress alone has the power to make such fundamental and all-important policy decisions.

The fiery legislator also accused the Commission of delays in granting permits and licenses and the violation or bypassing of its own regulations in many decisions.

Looks as if there is quite a series of roaring debates and hearings ahead for the Senate Commerce Committee, the FCC and other communication departments in Washington.

AN INTERESTING EVALUATION

of the growth of mobile units in the safety and special radio services, recently prepared by the FCC, shows that there are more than 200,000 units in the field.

The police lead the active users, with nearly 44,000 radio-equipped cars. Other users include the aeronautical group with close to 25,000 units; marine, over 17,000; industrial, nearly 28,000; forestry, over 7000; fire, nearly 3000; railroad, nearly 2000; transit utility, over 1000; special emergency, over 400; highway maintenance, nearly 400; and the experimental group, which includes taxicabs, buses and trucks, with close to 75,000 vehicles in the field.

In 1947, there were around 135,000 two-way cars licensed, and at the end of this year, it appears as though there'll be nearly 250,000 talk-and-listen equipped cars, trains, etc.

THE LONG-AWAITED

allocation rules for the mobile services have been issued and will become effective July 1. The order calling for new identities for the services, new frequencies for some users, and the elimination of some bands for others, affected railroad radio most, with 19 and 21 frequencies being lost in some areas. The train services, which are included in a *Land Transportation Radio Service* group, now have 47 frequencies in the 152 to 162 mc. band, 41 of which have been allocated for use in Chicago for the thirty-two roads which operate in and out of the city. Thirty-nine of these same frequencies are also used in areas outside of Chicago. In addition to these assignments, the roads also received eight developmental bands in the 450 to 460 mc. area, on a share basis with *Urban Transit Radio Service*.

Taxicab Radio received an increase

in channels, with eight frequencies in the 152-162 mc. band, in two blocks, each of four adjacent channels, allocated.

The new rules established a new service, *Automobile Emergency Radio Service*, developed to speed the dispatching of emergency road service repair vehicles by associations of private automobile owners and by public garages. This new service has one exclusive frequency in the 30 to 44 mc. band and two exclusive channels in the 450 to 460 mc. band, the upper band frequencies being available for experimental work only.

Police Radio Service lost some frequencies in the 152 to 162 mc. band to the *Maritime Mobile Service*, but was compensated for its loss by the allocation of an equal number of exclusive channels in the 158 to 159 mc. band. The shift in the 152 to 162 mc. band affects about eighty-five licenses operating about 1300 transmitters.

In recognition of the importance of radio communication in fire fighting, the Commission extended eligibility in the *Fire Radio Service* to rural and suburban volunteer fire companies, which are said to comprise the largest number of fire departments in this country.

The new rules also provide for an expansion of the former *Forestry Service* into a *Forestry Conservation Service*. Whereas, formerly, radio could be used only in connection with forest-fire-fighting activities, it will now be possible for states and others eligible to use radio for a wide range of conservation purposes, from flood control activities to the enforcement of fish and game laws. However, the new rules recognize the importance of forestry radio by providing priority for forest fire-fighting communications.

For the first time, the *Highway Maintenance Radio Service*, used chiefly by state highway departments in connection with repair and maintenance of highways, will be able to operate on a regular basis, having received exclusive frequencies in the 44 to 50 mc. band. The service will also be able to share frequencies in the 30 to 40 and 152 to 162 mc. bands.

The new rules also extend eligibility for the *Special Emergency Service*, as an expanded service, to include physicians in remote areas, ambulance service, beach patrols responsible for life saving activities and schoolbus operators.

There's a new *Relay Radio Press Service* also provided for in the rules, which permits complete mobile service operations, and includes units installed in reporter's and photographer's cars and base station transmitters in the newspaper office. For these operations, the service will share four frequencies in the 162 to 172 mc. range with the *Motion Picture Service* and twenty-frequencies in the higher band 450 to 460 mc. range, with other industrial services.

Radio facsimile received a bit of a setback in the new rules, the Commission denying the service any bands, declaring that at this time, this facility does not appear to be in the public interest. The Commission applauded the extensive and successful experiments of the *New York Daily Mirror* with this type of transmission, but found that such transmissions not only take a much longer time than the average radiotelephone message, but also require a higher degree of protection from interference for satisfactory operation. This type of operation, the Commission added, would find its principal application in metropolitan areas, where spectrum space is most in demand and where practically all channels must be shared by a number of licensees, or a very large number of mobile units, or in some areas both.

Considering the innumerable technical and economic problems which faced the FCC, they produced quite an effective mobile-service pattern, which should result in a stimulated interest in two-way.

RADAR played a major role in guiding the shuttling airlift planes to Berlin during the recent blockade. Atop a five-story building at Tempelhof Airfield was installed a steel tower with a rotating radar antenna which could see all air traffic within 100 miles of Berlin. The system provided a picture of only moving targets or aircraft and eliminated all ground clutter. . . L. W.

Within the Industry

(Continued from page 22)

vice-president; P. H. Hartmann, treasurer; W. F. Hoepfner, comptroller; Chester H. Wiggin, secretary and assistant treasurer; Dudley M. Day, assistant secretary; C. Douglas Webb, assistant secretary; John J. Brosnan, assistant treasurer; Edmond H. Dufau, assistant treasurer; and Roy H. Workman, assistant comptroller.

Board of directors chosen for the newly-formed corporation is comprised of Sosthenes Behn, George Everson, Philo T. Farnsworth, William H. Harrison, Charles D. Hilles, Jr., David R. Hull, Edwin A. Nicholas, Henry C. Roemer, and Ellery W. Stone.

* * *

RCA COMMUNICATIONS, INC., 66 Broad Street, San Francisco, California, has opened the first direct radiotelegraph circuit between San Francisco and Canton, China, and first commercial contact with the Canton station was made in San Francisco at 4 p.m. (PST) on April 27, 1949.

Operations with Canton are in addition to long-established RCA radiotelegraph service between the United States and Shanghai. Direct service has been opened by the company also between the Philippine Islands and Canton.

-50-

July, 1949

SEE LEO FIRST... for HALLICRAFTERS!

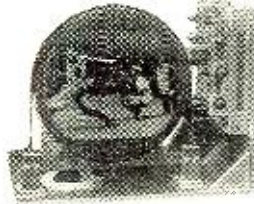

T-69 15 INCH TV CHASSIS

Now you can have big-picture television at a reasonable price! Brilliant 130 sq. inch picture on direct-view tube. All channel push-button tuning provides instant station selection. Has 300 ohm twin-wire lead for any standard antenna. 8 inch P.M. speaker. Operates on 105-125 volts 60 cycle, AC. 19 tubes, picture tube and 3 rectifiers. Ready for custom installation.

\$259.50



SAVINGS ON BRAND NEW MODELS TV RECEIVERS

No. 511—16" TV Remote Control	\$395.00
No. 512—12½" TV Console	\$299.50
No. 513—10" TV Table Model	\$199.50
No. 514—7" TV Portable (Built in antenna)	\$149.50
No. 515—15" TV Console in cabinet	\$399.50
No. 509—10" TV Receiver in cabinet	\$269.50
No. T-64—10" Custom TV Chassis with CR tube ...	\$179.50
No. T-64—12" Complete with 12" CR tube	\$199.50

SENSATIONAL NEW LOW PRICES

SX-43—less speaker	\$159.50
S-40A	\$ 79.95
S-53	\$ 69.95

20% DOWN — E-Z PAYMENTS

S-72 PORTABLE



Hallicrafters new versatile, extra-sensitive, all-wave portable receiver. Covers standard broadcast band and 3 CW bands—540 KC to 30.5 MC. Operates from built-in antennas—loop for broadcast and 27 inch whip for short-wave. Includes eight tubes and rectifier. Operates on 105-125 volts DC or 60 cycle AC or battery. Sturdily built—covered with handsome brown leatherette with brass plated hardware. 14 inches wide—12¼ inches high—7¼" deep.

\$79.95 (batteries not included).



GIANT RADIO REFERENCE MAP

Just right for your control room wall. Approximately 28"x42". Contains time zones, amateur zones, leading short-wave stations, monitoring stations. Mail Coupon Today and **25c**

FREE

The most complete Ham Catalog ever assembled. Send for your copy today!



WORLD RADIO LABORATORIES

744 West Broadway
Council Bluffs, Iowa

Please send me:

- New Catalog
 Radio Map
 List of Used Equipment

- T-69 TV Chassis
 S-72 Portable Radio
 New Model No.

Name.....
Address.....
City..... State.....

WANTED!

2,000 MP 48

most bases

400 SCR 608

200 SCR 300

NEW or GOOD CONDITION

Ers. ROYAL 19 rue chopin
BRUSSELS, BELGIUM

Make Your Career RADIO and TV

In no other industry does the future hold brighter financial promise and security than in AM and FM Radio. Television. These fields need and want men trained as announcers, script writers, disc jockeys, and radio technicians. It will pay you to investigate the Don Martin School of Radio Arts, established in 1937. Complete day and night classes... the latest equipment... and a staff of 30 nationally known instructors. Over 97% of the combination men graduates are placed on jobs immediately through the free placement service. Approved for veterans.

FREE—Write for Free Booklet "Your Future in Radio."

DON MARTIN SCHOOL OF RADIO ARTS
1655 No. Cherokee, Hollywood, Calif., HUDSON 23281

**TELEVISION
SERVICING at a
PRICE YOU CAN PAY**

**R. S. E. 3 inch
TELEVISION SCOPE**

Features:
WIDE BAND VER-
TICAL RESPONSE
FLAT TO 750kc
DOWN 3db
AT 1mc
VOLTAGE GAIN
OF 20 AT 5mc



AR-3

The R.S.E., AR-3 Scope has been built by Armstrong to our rigid specifications. It's a complete unit that embodies standard horizontal amplifier and sweep circuits with normal sensitivity.

The case is 8" high x 5" wide x 14" long, attractively finished in "hammered" opalescent blue enamel. Operates on standard 110 volts—60 cycles—40 watts. Tubes, 3BP1—6AC7—6SJ7—6X5—5Y3—884. Instructions included. Complete specifications upon request. Satisfaction or your money back.

PRICE
\$49⁹⁵

F. O. B.
DETROIT

**PUSHBACK
WIRE**



BELOW MILL PRICES!

2,000,000 feet—tinned copper—all 1st. class, double cotton serve, waxed finish. Available 1,000 foot rolls.

22 gauge (6 colors) \$3.98 roll
20 gauge (6 colors) 4.98 roll
18 gauge (brown only) 6.49 roll



**OZ4's
(No Limit)**

Fresh RK and RCA. Standard commercial grade, not JAN's.

BUY 12 **58c**
get 1 free EACH

EGG CRATE OF 100 **\$49⁰⁰**

ORDER INSTRUCTIONS



Minimum order—\$2.00. 25% deposit with order required for all C.O.D. shipments. Be sure to include sufficient postage—excess will be refunded. Orders received without postage will be shipped express collect. All prices F.O.B. Detroit.

**RADIO SUPPLY &
ENGINEERING CO., Inc.**
89 SELDEN AVE. DETROIT 1, MICH.

Technical
BOOKS

**INSTALLATION AND SERVICING
OF LOW-POWER PA SYSTEMS.**

John F. Rider. Published by *John F. Rider Publisher, Inc.*, New York. 208 pages. Price \$1.89.

According to the author of this book, the majority of public address installations are those requiring low-power equipment, from both acoustical and economic viewpoints. The apparatus discussed, therefore, is confined to a rating of 50 watts or lower.

Even though the use of sound amplification has become widespread, there are still many public address installations yet to be made. A large source of revenue is just waiting to be tapped by the enterprising, and an attempt has been made in this text to give the reader those facts and ideas on which he can build, and at the same time to give him a practical working knowledge of the subject, so that he can convert his knowledge into dollars and cents as he goes along.

Beginning with a 24-page chapter on the fundamentals of sound, the text devotes another 50 pages to microphones and phonograph pickups, and then enters into the more technical aspects of PA operation with impedance matching, amplifier specifications, loudspeakers, and installation and servicing. The last chapter deals with the use of the oscilloscope as a means of quickly diagnosing defects in a system.

Although the title of the book indicates a limitation on the application of the principles of this text, a great amount of the subject matter will apply equally well to systems of higher power.

* * *

ELECTRICIANS' POCKET COMPANION, by Benjamin Goldberg. Published by *Murray Hill Books, Inc.*, New York. 442 pages. Price \$2.50.

In simple language, uncluttered by discussions of nonessentials, this manual is written primarily for the electrical mechanic, apprentice, engineer, or contractor. It is a helpful reference book, providing many indexes and cross-indexes so that wanted information may easily be found.

Among the wiring diagrams are bell circuits, heating-system circuits, lighting circuits, meter connections, alternating-current motor connections, and telephone circuits, to name a few. Electrical formula applications are listed conveniently, and all of the tables used by electrical workers are included. The application of electrical trade mathematics is explained in the simplest way, with a problem and solution for each formula. There are diagrams on reversing motors, motor connection, etc. In addition, there are chapters on symbols and abbreviations, and on safety precautions and emergency first-aid treatments.

This book, based on the 1947 Na-

tional Electrical Code, will supply the hundreds of facts, figures and methods needed constantly by the practical electrician.

* * *

MOST OFTEN NEEDED 1949 RADIO DIAGRAMS AND SERVICING INFORMATION.

Compiled by M. N. Beitman. Published by *Supreme Publications, Chicago*. 160 pages. Price \$2.50.

This is first and foremost a manual of diagrams and servicing information for the experienced radioman who is thoroughly familiar with reading and interpreting such matter.

There are innumerable schematic diagrams of most of the popular radio models, such as *Admiral, Belmont, Crosley, DeWald, Emerson, Garod, General Electric, Hoffman, Howard, Airline, Motorola, Arvin, Olympic, Philco, RCA, Silvertone, Stewart Warner, Stromberg-Carlson*, as well as the auto radio models of *United Motors, Zenith, Westinghouse, and Truetone*, among others.

* * *

PRACTICAL TELEVISION SERVICING, by J. R. Johnson and J. H. Newitt.

Published by *Murray Hill Books, Inc.*, New York. 334 pages. Price \$4.00.

This is a practical manual on servicing television receivers. From the first chapter, devoted in part to a review of the types of television receivers, to the last, devoted to the newest developments in color television, the book proceeds through all phases of television servicing. There is nothing difficult to understand, as it starts with fundamentals and proceeds carefully and thoroughly.

Chapters on troubleshooting illustrate servicing problems with actual case histories and photographic examples of faulty reception. Block diagrams of receivers are used to show common faults of television circuits. The cathode-ray tube is usually the crux of the television servicing problem, and accordingly a chapter is devoted to a complete explanation. Cathode-ray tubes, however, are only one of the phases of television developed in this book. A complete analysis of the entire receiver is given.

-30-

**HOOSIER STATE
HAMFEST**

SUNDAY, July 24, is the date chosen for the 1949 Indiana Radio Club Council Picnic, which will begin at 11:00 a.m. Central Standard Time.

The site of the festivities is Tippecanoe River State Park, which is located five miles north of Winnemac on Indiana 29 or U. S. Highway 35.

The cost will be 50 cents each for registration for those over 16 years of age, and a state park fee of 12 cents per person must be charged, plus 10 cents for each car.

Publicity Chairman Ted K. Clifton, W9SWH, will handle all inquiries of those interested in attending the hamfest. Address Route 1, Coldwater Road, Fort Wayne 8, Indiana.

-30-

Mobile Transmitter

(Continued from page 33)

point is found at which no change occurs in the voltmeter reading as C_7 is tuned back and forth throughout its range. The final amplifier is not hard to neutralize, and the reader will find that after the neutralizing point is reached, a further increase in the capacitance of C_6 will upset the neutralization. (4) After neutralizing, replace the milliammeter lead and tune C_7 for minimum dip of the milliammeter deflection. (5) Go back through the tuning, readjusting C_2 , C_3 , and C_7 for an improvement in the milliammeter dip. (6) After the antenna is connected, adjust the antenna coupler, antenna height, or other adjustment, to raise the final amplifier plate current, at dip, to the full 15 milliamperes.

We noticed that replacing the cover of the transmitter case had negligible effect on the tuning. We had felt it was best to keep all tuning gadgets inside the case, to prevent accidental maladjustment. However, it will be advisable in such layouts to keep the coils as far as possible from the removable top in order to prevent detuning when the top is replaced after tuning-up.

Design Variations

Many variations, of course, are possible in the mechanical layout and construction of the rig. The circuit is entirely conventional and is adaptable readily to a variety of physical arrangements. The keynote of these efforts, however, is small size with low power—the size in the interest of the other purposes for which the car is used, and the power with respect to conserving the car battery.

-30-

TV EMPLOYMENT ON INCREASE

ALTHOUGH television at present utilizes only 57 stations, the industry employs approximately ten per-cent as many full-time people as do the combined AM-FM broadcast facilities, according to a recent NAB survey.

The largest number of these workers, or fifty per-cent, are technical employees. Only twenty-two per-cent are engaged in programming, while twenty per-cent are on the general administration and sales staffs. Eight per-cent make up the film department personnel.

The full-time staffs of these 57 television stations, including networks, total 3456 regulars and approximately 1600 part-time and free-lance individuals. An average individual television station was found to employ about forty-six persons full-time, and a typical network on New York City operations will have approximately 290.

Larger than average staffs are required by only thirteen per-cent of the stations, while as much as thirty-two per-cent employ fewer than thirty people.

-30-

July, 1949

4 ALL-META KITS

meet every service need

Streamline your shop and sharpen your service with these attractive IRC *All-Metal* Kits and Cabinets.

New *All-Metal* Resist-O-Kit is the latest addition to IRC's family of popular METAL kits. Small, flat size makes it ideal for service calls. Choice of 2 assortments—45 half watt, or 30 one watt resistors in popular ranges.

IRC Resist-O-Cabinets are again available in heavy-gauge metal. Large and sturdy, these *All-Metal* cabinets are supplied in 3 assortments—83 one watt, 100 half watt, or a combination assortment of 92 half, one and two watt insulated resistors and new close tolerance PRECISTORS—all carefully selected ranges. Four "non-spill" drawers and 28 compartments.

All-Metal IRC Volume Control Cabinet is a long time favorite in modern service shops. Stock of 18 interchangeable Fixed Shaft Controls plus switches and special shafts handles over 95% of all listings in the Industry Red Book. 20 compartments and 3 handy drawers.

For all of your daily resistor requirements (from 1/2 watts to heavy duty power wire wounds) IRC offers the *All-Metal* Basic Kit. Wide variety of selected values makes this your *basic* resistor stock. International Resistance Co., 401 N. Broad St., Phila. 8, Pa. In Canada: International Resistance Co., Ltd., Toronto, Licensee.



NEW RESIST-O-KIT

flat, all-metal 1 1/4" x 3 7/8" x 6 1/2" 1/2 and 1 watt assortments.



ALL-METAL RESIST-O-CABINET

choice of 3 resistor assortments, 4 drawers, 28 compartments.

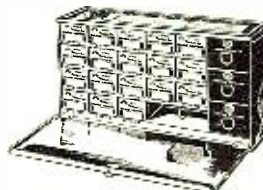

VOLUME CONTROL CABINET

all-metal, handles 95% of all listings in Industry Red Book.



ALL-METAL BASIC KIT

basic resistor stock, ideal for new service shops.

INTERNATIONAL RESISTANCE CO.

Wherever the Circuit Says ~~~



IRC ALL-METAL KITS ARE FURNISHED AT NO EXTRA CHARGE—YOU PAY ONLY THE REGULAR PRICE OF THE MERCHANDISE.



RADIO ENGINEERING TELEVISION ELECTRONICS

Thorough training in all phases of radio and electronics, open to high school and junior college graduates. Old established school specializing in Radio training exclusively. Modern laboratories and courses. Enrollments limited. Approved veteran training.

VALPARAISO TECHNICAL INSTITUTE
Dept. RD Valparaiso, Ind.

WAR SURPLUS BARGAINS

Gigantic mail sale electronic-radio-electrical apparatus. Amazing values. Opportunity for home experimenters, laboratories, schools, etc., to get fine new, or new condition guaranteed, equipment at fraction of original cost. We pay freight or postage. Typical items are listed below.

• 3000-watt, 115-volt, 60-c power plants	\$299.50
• Wheatstone bridges (0 to 11,110 ohms)	59.50
• Weston Air Part Photo-light Control Units	29.90
• Weston Model 689-IP Industrial Ohmmeter—1 case	12.90
• W. E. Desk or wall C.B. Telephones and ringer (complete)	4.99
• RCA (3", 3" and 2") Cathode Ray Tubes	3.55
• RCA Light, burglar alarm kit, consists of rectifier, photo cell, thyatron, relay, sockets, etc.	4.49
• Drill press 3 1/2" polishing-grinding shaft and stone	1.29

Other items include gas engines, chromolux elements, radar altimeters, tubes, transformers, etc. Order from ad or send card for bargain catalog. Satisfaction guaranteed. Our reference—National Bank of Commerce.

LECO ENGINEERING CO.

BOX 908 RTN-7 LINCOLN, NEBRASKA

MULTI-SOCKETS!

CATALOG 3005



For single crystal holder with 1/2" spacing. Will also receive MOSLEY CAT. 300P PLUG for deaending 300 ohm line.

CATALOG 53

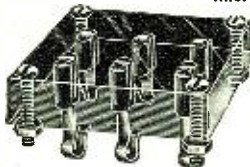

A three-way socket for mounting 3 crystals with 1/2" pin spacing side by side.



CATALOG 56 receives 6 crystals mounted side by side.

MOSLEY MULTI-SOCKETS are one-piece units that can be installed easily with the four screws provided.

MOSLEY CRYSTAL HOLDER ADAPTERS



(Catalog 5-75) Fits 1/2" crystal holder to 3/4" spacing.



(Catalog 75-5) Fits 3/4" crystal holder to 1/2" spacing.

FOR SALE AT YOUR JOBBER

MOSLEY ELECTRONIC SPECIALTIES
(WØFQY) 2125 LACKLAND ROAD,
OVERLAND (14) MISSOURI.

CLOSE OUT SALE

RM-29A TELEPHONES

Reduced to only **\$7.95** each 2 for \$14.95



Complete with handset and 4 1/2 volt "C" battery

Stock No. B-588H

Two or more of these units make an excellent private telephone system. Require only two wires connecting the two or more units. No external power required. Every unit has been completely reconditioned and tested and is guaranteed to be in excellent condition, ready to operate. Shipping weight - 16 lb.

Only a limited quantity in stock. Don't delay! This may be your last opportunity to take advantage of this outstanding surplus buy.

Outdoor Telephone-Intercom 3-CONDUCTOR CABLE

at less than 1¢ per foot

Stock No. C-561H

525 FOOT ROLLS

Only **\$4.95** per roll



Each conductor consists of four #28 steel strands for added strength and three #28 copper strands for extra conductivity and flexibility. Rubber insulation with two-ply waterproofed braid covering around each conductor. Net wt. 20 lbs. A wonderful buy for any telephone or inter-communication use requiring 2 or 3 conductor cable. Shipping weight - 20 lb.

Anticipate your needs on this wire!

Lay in a stock now. You will never again be able to duplicate this value.

TERMS -- cash with order, or 20% deposit - balance C. O. D. Prices are net. F. O. B. Dayton, Ohio

SREPCO Inc.
STANDARD RADIO & ELECTRONIC PRODUCTS
135 E. Second St. - DAYTON 2, OHIO - Tel. FILLIOS 2174

Disturbance Tests

(Continued from page 49)

can be suspected of being defective, and the usual resistance, voltage, and tube check is made in this circuit. However, if the saw-tooth is not heard at one point and found at the following check point, it evidently has been lost between these two points, and it is between these that the further check is made.

In the same way, audible checks can be made to localize the trouble in the vertical sweep circuit. We would proceed to this circuit if only a horizontal line appears on the screen, indicating a loss of vertical deflection.

Test Five: Using the same technique of audible signal tracing, one end of the clip lead is attached to the grid of the first audio and the .1 is used as a probe. The condenser lead is applied to the plate of the 6K6, V122, vertical output tube. If a loud, hoarse 60~ signal is heard, the saw-tooth is evidently there but has been lost between that point and the deflection yoke, and appropriate checks are made. If not found there, the clip is left on the audio grid and the condenser is moved in succession to the grid of the output tube, the plate of the 6J5, V121, vertical oscillator and discharge tube. If there is still no sound, the oscillator is out of commission and this circuit is checked.

If the tubes light up but no circuits appear to be operating—no spot on the screen, no sound, etc., we would suspect a failure in a part of the circuit common to all—the low voltage "B+" system.

Test Six: The standard disturbance test for low voltage "B+" is shorting a "B+" point quickly to the chassis with a screwdriver and observing the spark. No spark—no "B+"; small spark—low "B+"; large spark—normal "B+". Of course, it is simple enough to check for "B+" with a voltmeter. Unless normal "B+" is available, the set will not operate properly, and the reasons for abnormal "B+" must be checked—filter condensers, rectifier tubes, etc.

Disturbance tests for audio are standard and have been used for some time, and these will be covered quickly.

We suspect trouble in the audio strip when pictures come through without sound on all channels. This automatically points to trouble in the audio strip, which includes the audio amplifiers, discriminator, and sound i.f.'s.

Test Seven: The first audio test is pretty much standard practice and is designed to quickly localize the trouble to the front half (i.f. and discriminator) or last half (audio amp.) of the audio strip. The finger or the shank of a screwdriver with the finger touching it is put on the top of the potentiometer—volume control, R222. If a fairly loud 60~ hum is heard in the output, we assume the following

THE EVIDENCE of YOUR EARS



POINTS TO **NEWCOMB**

What you really buy in a phonograph amplifier is "listening quality" . . . that elusive characteristic which, after all, is any amplifier's prime reason for being.

That's why we insist that Newcomb amplifiers must not only measure up electrically but, in addition, must provide more real listening pleasure.

IT IS POSSIBLE TO PRODUCE AMPLIFIERS THAT SHOW PERFECT LABORATORY MEASUREMENTS, YET FALL FAR SHORT OF PROVIDING THIS ALL IMPORTANT LISTENING QUALITY.

Years of experience and a devotion to the ideal of fine reproduction have given us an insight into the factors that make for true listening quality. Careful design and engineering have enabled us to translate this insight into actual production.



KXLP-30 30 WATTS

Let your ear be the judge: insist on hearing a Newcomb. Compare the listening quality of Model KXLP-30 with that of any other amplifier. Note the pure, natural quality and true character of each deep bass note. You will find none of the undesirable, false, harmonic bass emphasis of the usual amplifier. Listen to the clear, undistorted, brilliant high tones and remarkable freedom from surface noise which the Magic Red Knob makes possible. Your ear will agree, Newcomb Sound is the closest you can get to "live music."

Send for specifications on this and other Newcomb phonograph amplifiers priced from \$59.50 retail.

Newcomb AUDIO PRODUCTS CO.

DEPT. F, 6824 LEXINGTON AVE. HOLLYWOOD 38, CALIFORNIA

stages are okay right through to the speaker and proceed to test the preceding stages. However, if nothing is heard, we make further checks in the rear half of the audio strip. Suppose nothing is heard.

Test Eight: We then take a screwdriver and quickly short plate of the power amplifier, 6K6, V109, to ground. The screwdriver is not kept there to avoid overloading the primary of the output transformer and the tube's screen grid. But shorting quickly two or three times should give a loud thump in the speaker if the output transformer and the speaker are functioning. If nothing is heard, the trouble is isolated to these two components.

Test Nine: The speaker field is checked to find if it is energized by putting the shank of the screwdriver near the speaker to feel the pull. If the field coil is operating, resistance checks are made of the voice coil and the output transformer primary and secondary. To be able to check both the secondary and the voice coil, it would be necessary to unsolder one lead. Before doing this, it might be advisable to feed in a signal from any convenient 6.3 volt filament to the grid of the output tube through our clip lead and condenser. An a.c. voltmeter is put across the output transformer secondary. If a voltage appears there and no sound is heard, the speaker is evidently the culprit.

However, if Test Eight gives the thumps, a further check is made to see if the output tube is operating.

Test Ten: A good method is the one mentioned just above—feeding in a 6.3 volt 60~ signal from any convenient filament pin through the condenser. The condenser is necessary because of the d.c. voltage appearing on the grid. A fairly loud 60~ hum should be heard if the output stage is functioning. If nothing is heard or the output is very low, the customary resistance, voltage, and tube checks on this stage should disclose the trouble.

Test Eleven: If this stage is good, a finger on the grid of the first audio tube, 6AT6, V108, should produce a loud hum if it is operating properly. If it is and no sound came through with the finger on the top of the potentiometer, we would check between these two points (open coupling condenser, etc.).

Test Twelve: On the other hand, suppose our first audio check, Test Seven, showed the audio stages were operating. We would then proceed directly to the grid of the 3rd sound i.f. for further disturbance testing. This will check the operation of the third i.f. and discriminator stages. Disturbance checks on the i.f. stages can take any of the following forms, as desired:

- (1) Scratching grid with screwdriver
- (2) Removing preceding tube from socket and replacing fast several times
- (3) Using test lead and condenser, clip one end of lead on a convenient "B+" point, and tap condenser rapidly on grid. The surge of charging current through the grid coil consti-

July, 1949

Our 27th Year



QUALITY—PRICE DEPENDABILITY

GRID DIP METER LYSCO "DIPMASTER"

3 Mc to 150 Mc frequency range; calibrated dial. Ideal for Signal generator, 3.4 to 300 Mc range phone monitor, F.S. meter, or absorption wavemeter. Complete power supply and tubes. Really a \$33.50 good buy at **\$33.50**



CONVERTERS

Mobile or Fixed. RF Gain control. Simple installation. Size 2" x 4" x 5"

Model 210—27 to 30 Mc-10 meters **\$25.50**
 Model 202—144 to 148 Mc-2 meters **25.50**
 3 tubes for converter **3.49**

TRANSMITTERS

Mobile or Emergency, 8 watt output crystal control, push to talk. Power requirements 6.3V. at 2 Amp; 350V. at 110 Ma. without dynamotor.

Model 129—27 to 29.7 Mc (10 meters) **\$23.95**
 Model 175—3750 to 4000 Kc (75 meters) **23.95**
 3 tubes for transmitter **4.98**
 Noise Limiter—Model NXL—adjustable threshold control. Power 6.3V—150 Ma. 100W. 6Ma. D.C. **\$4.50**
 6AL5 tube **1.11**

RAYTHEON VOLTAGE STABILIZERS

Positive Stabilization ±1/2%
 Input 95-130 volts, 60 cycles single phase; output 115 volts stabilized to ±1/2%. *Output 6.0 or 7.5 volts stabilized ±1/2%.



Catalog No.	Cap. Wgt. Watts lbs.	Net Price
VR-6110	15	\$15.00
VR-6101	30	\$17.00
VR-6111	30	\$17.00
VR-6112	60	\$24.00
VR-6113	120	\$31.00
VR-6114	250	\$48.00
VR-6115	500	\$75.00
VR-6116	1000	\$125.00

SCOPE & TELEVISION TRANSFORMERS & CHOKES

2500V. RMS @ 5 Ma D.C.—6.3V. @ 3 amps topped at 2.5V. @ 3 amps; 2.5V. @ 2 amps; type P-3171 **\$6.76**
 1700V. RMS @ 2 Ma D.C.—6.3V. @ 9 amps topped at 2.5V. @ 2 amps; 2.5V. @ 2 amps; type P-3170 **\$5.14**

2 Hys @ 250 Ma D.C. 50 ohms type C-2991 **\$1.62**
 2 Hys @ 200 Ma D.C. 50 ohms type C-2974 **\$1.92**

VERTICAL BLOCKING OSC. turns ratio pri. to sec. 1:4.2

Unshielded type A-3000 **\$1.18**
 Shielded type A-4000 **1.62**

HORIZONTAL BLOCKING OSC. turns ratio pri. to sec. 2:1

Unshielded type A-3002 **\$1.32**
 Shielded type A-4002 **1.76**

VERTICAL OUTPUT turns ratio pri. to sec. 10:1

Unshielded. type A-3035 **\$3.09**

RELAYS CS DIFFERENTIAL

Dual coil with armature pivoted normally open. Operates 220-250 Volts. 8000 ohms each coil, contacts S.P.D.T. Controls rated 2 amps. at 110 VAC. Ideally suited for balanced or bridge type circuits where limited current or power is available **88c**



GENERAL ELECTRIC PYRANOL CONDENSER

1 Mfd 15000 V.D.C. Brand New. Shipping Weight 35 lbs. A Terrific Value **\$10.95**

GREENLEE PUNCHES

Cuts to 1/8" thick metal.

1/2"	\$1.94
3/8"	\$1.94
11/16"	\$2.12
1-3/16"	\$2.25
1 1/2"	\$2.25
2"	\$2.88

We carry a complete line of all sizes of punches up to 3 1/2" diameter.

OIL FILLED CONDENSERS

1.78 Mfd 200 V.A.C.	\$.29
1 Mfd 600 V.D.C.	.29
2 Mfd 600 V.D.C.	.39
7.5 Mfd 330 V.A.C.	.98
10 Mfd 330 V.A.C.	1.23
2 Mfd 1000 V.D.C.	.59

HEAVY

25 Mfd 6000 V.D.C.	1.69
1 Mfd 5000 V.D.C.	2.95
1 Mfd 15000 V.D.C.	10.95

ALUMINUM CHASSIS—Heavy Duty

7 x 7 x 2	94c
7 x 9 x 2	\$1.06
5 x 10 x 3	\$1.00
7 x 11 x 2	\$1.15
7 x 13 x 2	\$1.23
10 x 17 x 3	\$1.88

STEEL CHASSIS 16 GAUGE

4 x 17 x 3 Black Crackle	\$1.05
10 x 17 x 3 Cadmium	1.17
11 x 14 x 3 Black Crackle	1.44
13 x 17 x 3 Black Crackle	1.94
13 x 17 x 4 Black Crackle	2.35
Complete stock of steel & aluminum chassis & panels on hand.	

ISOLATION TRANSFORMERS

All 117 Volts to 117 Volts 60 Cy.

P-96, 40 watts	\$3.60
P-98, 100 watts	\$9.30
P-97, 80 watts	\$5.10
P-99, 250 watts	\$17.70

SELSYN MOTORS

115 V.A.C. 60 cycle #C-78248. Can be used to turn small antennas or as indicators. Size 3 1/2" x 5 1/2". Price per pair **\$6.95**



TRANSFORMER SPECIAL

870 volt CT @ 250Ma with 80V bias tap
 5 volts @ 3 amps
 2 1/2 volts CT @ 10 amps
 2 1/2 volts @ 3 amps
 6.3 volts @ 1.5 amps
 115V. 60 cycle primary **\$5.88**

ITEMS YOU MAY BE LOOKING FOR

Multiple Contact Telephone Type Relay No. A2-2—Windings 125 ohms. Each. **\$.49**
 No. A1—Single winding 12,500 ohms. **.49**
 Heineman 5 amp. circuit breaker. **.95**
 Sockets for 813, 829 **.73**
 1/4 watt Neons bayonet base **.20**
 Sockets for 832 **.49**

LEDS RADIO CO.

75 Vesey Street Dept. RN7
 CORtlandt 7-2612 New York City 7

If not rated 25% with order, balance C.O.D. All prices F.O.B. our warehouse New York. No order under \$2.00. We ship to any part of the globe.



RADIO COURSES

Preparatory Mathematics, Broadcast, Marine Operating, Servicing, Aeronautical, Television, Frequency Modulation, Radar.

Classes forming for Fall term Oct. 1.
Entrance examination Sept. 19
 Veteran Training. Literature

COMMERCIAL RADIO INSTITUTE

(Founded 1926)
 38 W. Biddle St. Baltimore 1, Md.

EASY TO LEARN CODE

It is easy to learn or increase speed with an Instructograph Code Teacher. Affords the quickest and most practical method yet developed. For beginners or advanced students. Available tapes from beginner's alphabet to typical messages on all subjects. Speed range 5 to 40 WPM. Always ready—no QRM.

ENDORSED BY THOUSANDS!

The Instructograph Code Teacher literally takes the place of an operator-instructor and enables anyone to learn and master code without further assistance. Thousands of successful operators have "acquired the code" with the Instructograph System. Write today for convenient rental and purchase plans.



INSTRUCTOGRAPH COMPANY

4711 SHERIDAN ROAD, CHICAGO 40, ILLINOIS

TITONE
picks up profit NOW!

NOW! A \$10 SALE
for every record-player in your area!

LIST PRICE \$7.50

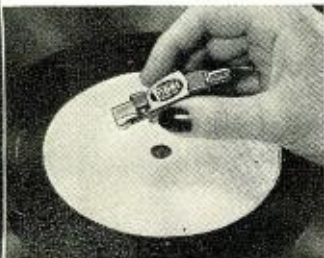

SELL NEW TITONE PICKUP
to every customer!

Here's a way to quick profit from every player owner who visits your shop! Have your salesmen "plug" it on every service call! First basic pick-up advance in over 10 years—the original piezoelectric ceramic pickup, made by SONOTONE, famous makers of hearing aids and miniature tubes!

- SELLS ITSELF IN A 2-TO-5-MINUTE CALL! Fits all tone arms. Let all your customers hear TITONE. They'll say "SOLD!" because—
- TRANSCRIPTION TONE QUALITY! Full frequency to 10,000 cycles! Real high fidelity! Bell-like supertone makes even old players thrilling!
- SURE-FIRE IN HUMID CLIMATES! Utterly unaffected by climate, moisture, fungus! Booms sales, wins back customers.
- DOUBLES RECORD LIFE AND PLEASURE! Gives "ordinary" records sparkling quality—revives worn favorites. Will play down to 1/2 normal pressure. NO "needle talk"!
- RUGGED! PERMANENT! No crystals, magnets, filaments to fail! No pre-amplifiers. Ceramic TITONE performs perfectly for years!

NO TONE LIKE
TITONE

CALL YOUR JOBBER—
or write now to
SONOTONE, Box T-2 Elmsford, N. Y.

tutes a good noise signal that is sent through to the speaker, if the stage is working.

In any of these cases, noise should be heard in the speaker. If not, these two stages are checked further. If noise is heard, we go back a stage to the grid of the second i.f., and to grid of the first i.f., if necessary, until the defective stage is found, and then make further checks to find the defective part.

Let us assume, however, that we get sound on the different channels, but no video information appears on the screen, although a normal raster is seen (white rectangle of light—no picture). This immediately localizes the trouble to the video strip—video amp., detector, video i.f.'s. Here again, quick disturbance checks are available to localize the defective stage in a hurry.

Test Thirteen: Our first check here should attempt to determine definitely whether the trouble is before or after the detector stage. A screwdriver is placed on the plate of the second detector, 6AL5, V114A, and the shank touched with the finger. A 60~ hum pattern should appear on the screen if the following stages are working. This shows up as a broad black and white band across the face of the CRT. If the 60~ pattern is seen, we assume the following stages are good, and go on to the preceding ones. If it is not seen, we assume the trouble is after that point, and we go to the grid of the CRT (tie point under chassis where the grid lead is taken off).

Test Fourteen: Clip lead and .1 condenser is used with the lead clipped on to a 6.3 volt filament pin. Condenser is touched to CRT grid lead. If this circuit is okay, the 60~ pattern is seen on the screen. If it is not seen, continuity of the lead is checked, resistance and voltage readings made at this point to check for shorts or a leaky coupling condenser, and possibility of bad contact of grid pin in CRT socket or of internal defect in CRT is checked.

If the 60~ pattern is seen, clip is left on the 6.3 volt a.c. filament and signal is fed from the condenser to the grid of the second video amplifier, 6K6, V116. The screen should show the 60~ pattern if the stage is operating. As usual, if it is not seen, it indicates the stage is defective and requires a further check. On the other hand, if this stage is good, clip is still left on the filament and the signal is injected through the condenser to the grid of the first video amplifier, 6AU6, V115. The old rule applies. Between the points we last saw the signal and lost the signal is the locality of the trouble, and it is here that we check further for the defect.

If Test Thirteen shows the set to be operating after the detector load resistor, it is necessary to proceed toward the front end of the receiver.

For disturbance tests on the video i.f., the contrast control should be maximum (fully clock-wise) and the

brilliance control adjusted until the raster can just be seen.

Test Fifteen: A .1 condenser and clip lead are used. Clip onto a high "B+" point, such as between the centering controls. The condenser lead is tapped rapidly on the cathode pin of the second detector, 6AL5, V114A. If the stage is operating, the raster should get brighter in step with the tapping as the charging current through the cathode coil creates a noise signal, visible on the screen.

If the detector is operating, the condenser tapping procedure, with the other clip left on the "B+" point, goes on to the grid of the fourth i.f., third i.f., second i.f., and first i.f., until no light flashes are seen on the screen, at which point further checks are made

It might be pointed out that disturbance tests in the video i.f. section are not as clear-cut as they are in other sections of the receiver, because of the possibilities of interaction through the common bias supply, to the video amplifier grids. A few minutes spent in performing the video i.f. tests on a good set would be well spent. The tests should then be repeated a second time, taking out each tube before the signal is fed in on the grid. It will be noticed that even with the tube out there is some displacement of the raster, though it does not become brighter. By noting the exact action of a good stage (tube in) and a bad stage (tube out), it will be easy to interpret readings in the future.

The only other main section of the set to be covered is the front end. Trouble is suspected here when neither sound nor video information comes through on any channel, even though a raster is visible.

Test Sixteen: To eliminate the possibility that the trouble is in the antenna, the antenna should be disconnected and a screwdriver pulled rapidly several times across the antenna terminals. (Contrast control maximum, brilliance low.) Flashes of light will be seen on the screen if the front end is operating.

If no flashes are seen, it is necessary to isolate the trouble to one of the three front-end stages—r.f., mixer, or oscillator.

Test Seventeen: The r.f. tube, 6J6, V1, is put in and out of its socket quickly several times, with the volume control at maximum. Noise heard in the speaker would indicate the mixer stage is operating, since it obviously passes the signal.

When the oscillator is suspected of being defective, the grids can be shorted to ground with a screwdriver. Noise should be heard in the speaker if the oscillator is functioning, since the negative voltage on the grid will be shorted out, changing the current through the tube and producing a noise signal. An inoperative oscillator will have no negative voltage, and so no current change will take place.

Voltage and resistance checks on the front end compared to the indicated

RADIO & TELEVISION NEWS

readings on the schematic or in the service manual should indicate the trouble.

To sum up, disturbance tests can be very handy for quickly localizing trouble where there is a dead or weak stage. The defective component can then be found generally by voltage and resistance readings or the substitution of a known good tube. Where disturbance tests do not give a definite indication of trouble, the service technician can turn to signal tracing with an oscilloscope in the sweep circuits, and signal injection with a signal generator and meter or 'scope in the signal circuits, not only to check the functioning of each stage but also to measure its gain.

-30-

TV ANTENNA ADJUSTMENTS

THE positioning of television antennas continues to remain a problem. One way to reduce the time of this operation is by means of an automatic station locator. This can be made very simply by marking the position of the stations on a pocket compass. A glance at the compass will instantly show the direction of the station, permitting immediate rooftop orientation.

The compass reading will be reasonably correct for most locations not directly in the city. Slight adjustments to compensate for local reflections should be made where needed. . H.P.

HOLDERS FOR SMALL PARTS

MANY fellows use glass jars on their workbenches to store screws, bolts, washers, and other small hardware; but glass jars do get broken, while a neat little container, made of metal, will stand up under a whole series of hammer side-swipes.

The metal cans in which certain brands of cough lozenges are packed are ideal, but, of course, any similar-size tin would do. If you intend using acid-core solder boxes, be sure to wash them out thoroughly.

By means of a radio socket punch (Greenlee), a 1/8 inch hole is punched in the cover of the box and a celluloid disc cemented over the hole. In this way, you can see right into the box and know what is inside.

A special advantage to using flat tins is that they can be stacked—you can make yourself a whole filing system of small parts boxes. If you desire, you can type out small labels and paste them on the side of each of the stacked boxes. Give the labels a coat of clear nail polish or lacquer so as to protect them from grime.

-30-



July, 1949

Buy with confidence—money-back guarantee
R & M's million dollar stock

SURPLUS GEAR ♦ STANDARD PARTS

IMMEDIATE DELIVERY

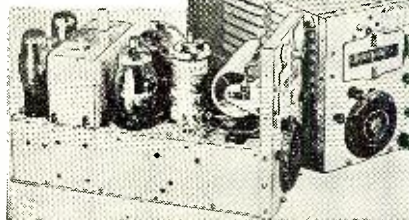

COMMAND SET

BC 453 Rec.....	\$16.95	BC 457 Xmfr.....	8.95
BC 454 Rec.....	9.95	BC 458 Xmfr.....	9.95
BC 455 Rec.....	9.95	BC 442 Relay.....	2.45
BC 456 Speech Amp.....		\$3.75	

APN-4 RCVR SCOPE POWER SUPPLY

Has power supply for 5" scope; electronic-controlled low v. supply; delivers 260 vdc. 150 mills req. to .01%. With 13 tubes.

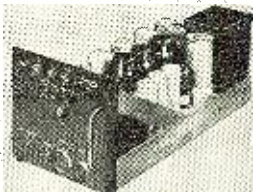

\$8.95

BC 221 FREQ. METER, complete with original crystal and calibration chart; new condition. Unmodulated, \$99.95 Modulated, \$149.95

6-volt Mobile DYNAMOTORS DUAL POWER SUPPLY

\$4.95 each

Low voltage 300 volts at 24 watts, use two double voltage.



ALL BAND TV and FM ANTENNA

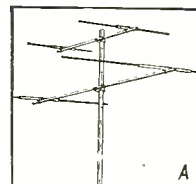

A High and low band dipoles and reflectors with 6 ft. mast 72-ohm.

\$7.65

In lots of 6, \$7.05 ea.

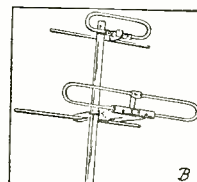

B High and low band folded dipoles and reflectors with 6 ft. mast 300-ohm.

\$8.75

In lots of 6, \$8.05 ea.

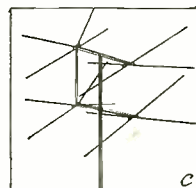

C Conical stacked array and reflectors; all bands; with 10 ft. mast for 72 or 300-ohms; good up to 125 miles.

\$24.85

D Indoor, all-channel, TV & FM aerial; with heavy base.

\$6.95 value

\$3.00

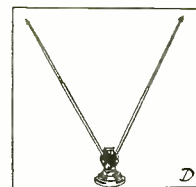

300-ohm twin lead cable, per 100 ft., \$1.69; per 1000 ft., \$11.69. 72-ohm co-ax cable, per ft., .06; per 1000 ft., \$33.00.

Insulated carbon resistors, 1/2 and 1 watt . . . 50 assorted, \$1.29 . . . 250 assorted, \$5.00.

TERMS: All orders F.O.B. our warehouses. Orders \$10 or less, cash with order; orders above \$10.00, 25% deposit, balance C.O.D.

R & M Radio Co.
2701 Wilson Blvd., Arlington, Va.

DEPT. RN 79

\$\$\$ SAVE \$\$\$

FOR BETTER BUYS,
FASTER SERVICE, WRITE
FOR OUR SPECIAL BULLETIN

CLEAR-VAC has the BUYS!

Largest selection of **RADIO TUBES**
and miscellaneous **PARTS**

Refer to our full page advertisement in the June issue of "Radio News" for TOP VALUES . . . or send for catalog sheet.

CLEAR-VAC CO.

5036 Ravenswood Ave.
Chicago, Ill.

"Clear Heads Order from CLEAR-VAC"

FOUND!

the "MISSING LINK" to
GOOD TV ANTENNA
INSTALLATIONS

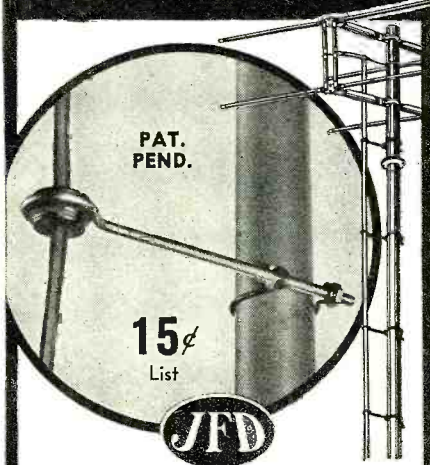

MAST CLAMP LEAD-IN SUPPORTS

Made with POLYETHYLENE
(the ultra-low loss insulation material)

Now you can make any old or new TV installation last longer, look neater, perform better with the unique JFD Mast-Clamp Lead-In Supports. These new Screw Eye Insulators are JFD-engineered to anchor lead-ins firmly in place and assure better TV/FM reception.



TL100-350
1" Clamp with 3/2" Screw
Eye for Twin Lead. **15c**
List



RG100-350
1" Clamp with 3/2" Screw
Eye for Coaxial
Cable. **15c**
List



DTL100-350
1" Clamp with 3/2" Screw
Eye for two Twin Leads. **35c** List



DBR18TL3
3/2" Screw Eye with wood-
screw thread, for two Twin
Leads. **28c** List

Mast Clamps are made in all sizes for all applications, individually designed to fit masts from 1/2" to 2" O.D. Screw Eyes range from 3/2" to 12" in length.

JFD MANUFACTURING CO. Inc.

6111 16th Ave. Brooklyn 4, N. Y.

WRITE TODAY
for Valuable 4-page Bulletin #DBR

© Copyright 1949 by JFD Mfg. Co. Inc.

FIRST In Television Antennas and Accessories

All rights reserved. No part of above work may be reproduced in any form except by written permission of the manufacturer.

Beginning Amateur

(Continued from page 51)

code speed goes up and you get into the 25 to 35 word-per-minute class, you're bound to consider a "speed key." This is popularly known as a "bug" because the trade mark of the oldest key of this type, the *Vibroflex*, is the outline of a lightning bug. It is also referred to as a "side swiper," for the simple reason that the operating levers work back and forth instead of up and down, as with the straight key.

If you push or press the left side of the double-finger knob, a vibrating arm is set into motion. At a speed depending on the setting of two sliding weights, contacts attached to the arm make and break rapidly, thus producing a series of dots. Holding the lever over, you can get about ten dots before the arm stops vibrating. Since the longest character in the Continental Code is the error signal (eight dots), you have plenty of reserve. To make fewer dots, you merely hold the lever for a shorter time.

The other or right side of the finger knob works a straight pair of contacts for the making of dashes, just as with a straight key. To make combinations

of dots and dashes, you twitch your thumb and first finger back and forth.

A bug in the hands of a skilled brass pounder makes music in the ears of the receiving operator. In the hands of a guy who is in too much of a hurry it makes a lot of indigestible hash. Hold the dot lever closed just a trifle too long and the letter *E* becomes *I*, *I* becomes *S*, and *H* is likely to be either *5* or the error sign; the last named is at least appropriate. The secret of good speed key operation is a keying monitor of some sort, to enable you to hear your own sending as it goes out. The actual signals of the transmitter produce such bad thumping in the receiver that they cannot be relied on as an indication of the keying technique.

A new and very interesting gadget called the "Mon-Key" is attracting attention among hams because it makes both dots and dashes automatically, by means of a trick circuit known as the "multivibrator." The finger mechanism is practically the same as that of the *Vibroflex*, but the levers are mere switches and are not weighted. The speed of the dots and dashes is controlled by a series of tapped resistors in the multivibrator circuit, over a range of about 8 to 45 words-per-minute. The finger technique is quite dif-

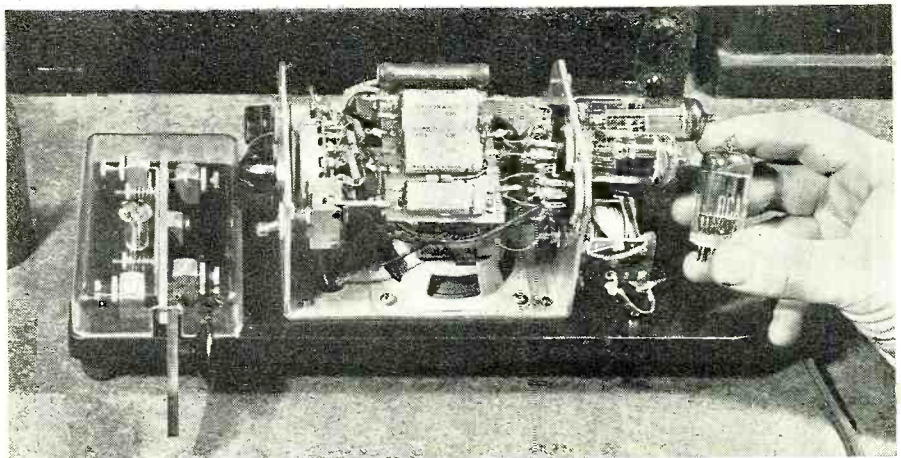

Mon-Key with cover removed to show the "works." Note base-mounted loudspeaker.

The speed key of the Vibroplex type has been popular with telegraphers for many years and is well adapted to high-speed radio operation. This shiny nickel and gold job makes an attractive addition to any ham shack.

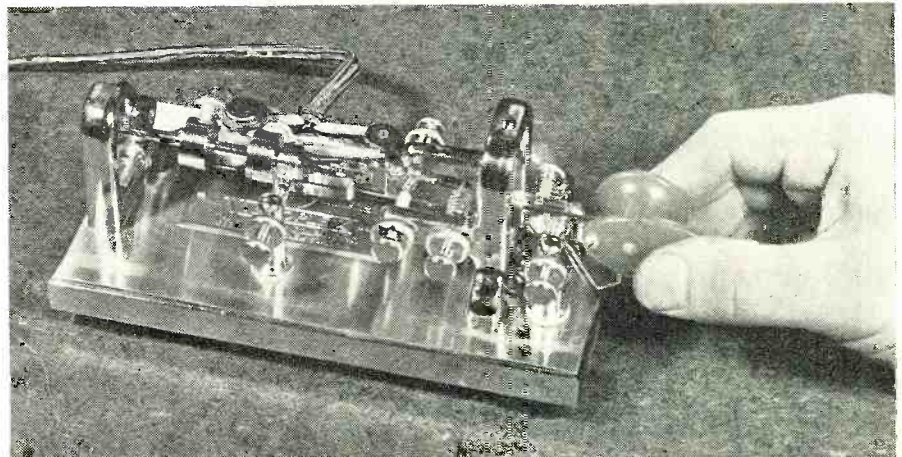

ferent from that used with either a straight key or a bug and demands a lot of practice. The unit contains three tubes and a built-in monitor loud speaker, which is essential to the mastery of the instrument.

A semi-automatic key is no substitute for carefulness. Your sending with a twenty-nine-cent, war-weary Signal Corps key can be clean or sloppy, as it can be on a twenty-nine-dollar electronic marvel. By taming down a tendency to race away with the dots and dashes, you'll work more stations because what you send will be understood.

A good operator gets into the habit of listening before he transmits. Too many hams warm up their transmitters first and start reeling off CQ's even before their receivers are hot. Know what's already on the air before you add to the confusion. You can never tell what you'll hear in the way of emergency traffic concerning floods, storms, fires, and other disasters.

(To be continued)

SNOW EFFECT IN TELEVISION RECEIVERS

BY MATTHEW MANDL

THE "snow" or "salt and pepper" effects so often noticeable in television receivers, are not due to noise pulses coming into the antenna, but are a direct result of the thermal agitation noise developed by the r.f. amplifier tube. This snow effect is usually visible when weak stations are tuned in, because under such conditions the contrast control is set high, and the bias on the r.f. tubes decreased, so that full gain may be realized. Tube noises are thus amplified and appear on the screen, due to the low signal-to-noise ratio. With a station of good signal level, the contrast control (or a.g.c. circuit) increases the bias, and the signal-to-noise ratio is high, which lessens the snow effect correspondingly.

Often, however, even a good signal to noise ratio fails to reduce the snow effect, in which case the r.f. amplifier tube should be checked as a possible offender. Some of the miniature amplifier tubes used are prone to be more noisy than others, and several should be substituted for the original until one is found which will decrease the snow effect on the picture screen.

Poor alignment in the video i.f. stages, or poor tracking in the r.f., mixer, and oscillator sections can also increase the snow effect because the resultant poor gain will necessitate turning up the contrast control to a setting higher than would normally be necessary.

Ignition and other types of man-made static do not appear as snow on the screen, but manifest themselves as streaks riding across the picture tube. In receivers where the sweep circuits are not adjusted properly and are unstable, tearing or rolling of the picture may occur. Other undesirable effects in the picture may be due to diathermy, x-ray and other high frequency equipment in the neighborhood, which will produce ripple-like beat note patterns on the screen. Snow effect, however, is produced by none of these, and originates within the receiver under the conditions previously outlined.

TUBES! NATIONALLY ADVERTISED BRANDS TUBES!

RCA — Kenrad — Sylvania — Tung-Sol — National Union — Raytheon — Philco — Hytron
All new tubes. 100% guaranteed. Individually boxed.

REMEMBER—OUR TUBES ARE FULLY GUARANTEED. EVERY TUBE IS BRAND NEW. These Tubes Are NOT Manufacturer's Rejects or Seconds.

TYPE	PRICE	TYPE	PRICE	TYPE	PRICE	TYPE	PRICE	TYPE	PRICE	TYPE	PRICE
0A4G	\$.096	2X2	\$.115	6K6GT	\$.054	6Y7G	\$.115	12C8	\$.115	35W4	\$.045
01A	\$.80	3A4	\$.72	6K7G	\$.60	6Z7G	\$.140	12H6	\$.65	35Y4	\$.65
0Z4	\$.80	3B7/12B	\$.96	6K8	\$.85	6Z7SG	\$.80	12J5GT	\$.54	35Z4GT	\$.54
1A3	\$.40	3D6/1299	\$.96	6L5G	\$.96	7A5	\$.72	12K7GT	\$.72	35Z5GT	\$.96
1A4P	\$.40	3Q4	\$.80	6L6	\$.96	7A6	\$.72	12K8	\$.65	36	\$.45
1A5GT	\$.65	3Q5GT	\$.85	6L6GA	\$.115	7A7	\$.72	12Q7GT	\$.65	37	\$.65
1A6	\$.115	3S4	\$.72	6L7	\$.115	7A8	\$.72	12SA7GT	\$.65	38	\$.80
1A7GT	\$.72	3R4GY	\$.115	6N7	\$.85	7B4	\$.72	12SA7GT	\$.65	39/44	\$.96
1B4P	\$.40	5T4	\$.40	6P5GT	\$.80	7B5	\$.72	12SC7	\$.80	40	\$.80
1B5/235	\$.115	5U4G	\$.54	6Q7	\$.72	7B6	\$.72	12SF5	\$.65	41	\$.60
1C5GT	\$.80	5V4	\$.85	6R7	\$.96	7B7	\$.72	12SF7	\$.72	42	\$.60
1C6	\$.115	5W4	\$.96	6R7GT	\$.65	7B8	\$.72	12SG7	\$.72	45	\$.60
1C7	\$.115	5X4G	\$.65	6S7	\$.96	7C5	\$.72	12SH7	\$.80	45Z3	\$.65
1D5GP	\$.140	5Y3GT	\$.45	6S8GT	\$.85	7C6	\$.72	12S17GT	\$.60	45Z5GT	\$.65
1D7G	\$.115	5Y4G	\$.54	6SA7GT	\$.60	7C7	\$.72	12SK7GT	\$.60	46	\$.72
1D8GP	\$.140	5Z3	\$.65	6S87-Y	\$.85	7E6	\$.72	12SL7GT	\$.85	47	\$.85
1E3GP	\$.140	5Z4	\$.96	6SC7	\$.72	7E7	\$.80	12SN7GT	\$.80	48	\$.140
1E7GT	\$.140	6A3	\$.96	6SD7GT	\$.115	7F7	\$.80	12SQ7GT	\$.60	50	\$.140
1F4	\$.96	6A4/LA	\$.115	6SF5	\$.72	7F8	\$.96	12SR7	\$.80	50A5	\$.80
1F5G	\$.96	6A6	\$.96	6SF7	\$.72	7H7	\$.96	12Z3(GZ5)	\$.96	50B5	\$.72
1G4	\$.96	6A7	\$.72	6SG7	\$.72	7J7	\$.96	12Z5(GZ5)	\$.96	50L6GT	\$.86
1G6GT	\$.96	6A8GT	\$.72	6SH7	\$.80	7L7	\$.96	14A4	\$.96	50X6	\$.80
1H4G	\$.80	6A87	\$.115	6SJ7	\$.60	7L7	\$.96	14A7	\$.80	50Y6GT	\$.65
1H5GT	\$.60	6AC7	\$.96	6SK7GT	\$.60	7M7	\$.80	14B6	\$.80	50	\$.96
1H6G	\$.115	6AD7G	\$.115	6SL7GT	\$.85	7N7	\$.80	14C7	\$.80	56	\$.65
1J6G	\$.96	6AF6G	\$.96	6SN7GT	\$.80	7Q7	\$.65	14F7	\$.80	57	\$.80
1L4	\$.72	6AG5	\$.125	6SQ7	\$.60	7W7	\$.96	14H7	\$.80	70L7GT	\$.140
1LA4	\$.96	6AG7	\$.115	6SR7	\$.65	7X7	\$.96	14J7	\$.96	71A	\$.72
1LA6	\$.96	6AK3	\$.125	6SS7	\$.65	(XXFM)	\$.96	14N7	\$.96	75	\$.60
1LB4	\$.96	6AL5	\$.96	6ST7	\$.96	7Y4	\$.72	14Q7	\$.80	76	\$.60
1LC5	\$.96	6AL7	\$.96	6SV7	\$.115	7Z4	\$.72	14R7	\$.80	77	\$.60
1LD5	\$.96	6AQ7	\$.80	6V7G	\$.115	10	\$.140	14W7	\$.96	78	\$.96
1LG5	\$.96	6AT6	\$.54	6U5	\$.72	12A	\$.65	19	\$.115	80	\$.45
1LE3	\$.96	6B4G	\$.96	6U6	\$.65	12A3	\$.115	22	\$.115	81	\$.140
1LH4	\$.96	6B7	\$.115	6U7	\$.65	12A6	\$.96	24A	\$.80	82	\$.96
1LN5	\$.96	6B8G	\$.115	6V6	\$.115	12A7	\$.115	25L6GT	\$.60	83	\$.96
1NSGT	\$.72	6C4	\$.60	6V6GT	\$.72	12A8	\$.72	25Z5	\$.54	83V	\$.115
1P5GT	\$.80	6C5	\$.60	6V7G	\$.96	12A87GT	\$.115	25Z6GT	\$.60	84/6Z4	\$.65
1Q5GT	\$.96	6C6	\$.72	6W7G	\$.96	12AT6	\$.60	26	\$.65	85	\$.80
1R4	\$.96	6C8G	\$.115	6X5GT	\$.54	12BA6	\$.65	27	\$.54	89	\$.80
1R5	\$.72	6D6	\$.60	6Y6G	\$.85	12BE6	\$.65	2807	\$.115	117L7GT	\$.140
1S4	\$.85	6E5	\$.80					30	\$.72	117N7GT	\$.140
1S5	\$.65	6F5GT	\$.60					31	\$.96	117P7GT	\$.140
1T4	\$.72	6F6	\$.72					32	\$.115	117Z3	\$.65
1T5GT	\$.96	6F7	\$.115					32L7GT	\$.115	117Z6GT	\$.85
1V	\$.80	6F8G	\$.115					33	\$.115	VR-90	\$.96
2A3	\$.115	6G6G	\$.96					34	\$.115	VR-105	\$.96
2A4G	\$.115	6H6GT	\$.60					35	\$.72	VR-150	\$.96
2A5	\$.80	6J5GT	\$.54					35A5	\$.72	9001	\$.80
2A6	\$.96	6J6	\$.125					35B5	\$.72	9006	\$.80
2B7	\$.96	6J7	\$.72					35L6GT	\$.66	FM-1000	\$.115

TERMS: 25% with Order
—Balance C.O.D.—F.O.B.
Chicago. Prices Subject
to Change Without Notice.
Minimum Order \$2.00.

FRANKLIN-ELLIS CO. 1313 West Randolph Street
Dept. RN-7 Chicago 7, Illinois

GEIGER COUNTERS

HAM! BE FIRST AGAIN! BUILD YOUR OWN!
Find radium, trace water mains, prospect,
check local contamination, assay ores.

SENSATIONAL BETA COUNTER! 30 MG/CM²
WALLS

- Send Beta counter.....\$ 7.50
- Send complete parts kit and diagram. 48.50
- Send assembled 5.5 pound portable.. 90.00
- Send 110VAC quantitative lab. model 150.00
- Send detailed information Check COD

AEC Bulletins available.

COSMIC COUNTERS

112 Cornell Ave. Swarthmore, Pa.

LEARN

TELEVISION ELECTRONICS RADIO

Modern Completely Equipped
Laboratories

DAY AND EVENING CLASSES

G.I. Approved—Veterans Receive
Subsistence

ENROLL NOW!

ELECTRONICS INSTITUTE, INC.

21 Henry, Detroit 1, Mich.

DISTRIBUTORS and DEALERS WANTED

for TELEVISION TOWERS

It will pay you to write us for details—because this is one of the best engineered lines of T.V. Towers developed . . . and priced right for competition too!

- 10 to 220 feet height
- Mobile or Stationary
- Electric Welded Steel Tubes
- Light Weight
- Immerse Treated or Galvanized

Get in on the ground floor for good profits!

Write or wire now—Dept. 2

AERO TOWERS

1016-24 Linden St.

Allentown, Pa.

SUMMER SPECIALS

MOBILE

6V. DYNAMOTOR. Output 190 v. at 70 MA, 9 amp. drain; second winding gives 350 to 250 v. at 50 to 100 MA, 10 to 15 amp. drain. Complete instructions. **NEW \$3.25**
TC5-7 XMTR DYNAMOTOR. 12 v. input gives 440 v. at 200 MA continuous, much higher on intermittent. **NEW \$5.95**
BD-77 FOR HI-POWER MOBILE RIGS. 12 v. input gives 1000 v., 350 MA continuous. **EXCELLENT USED, WHILE THEY LAST \$5.95**

MARINE

ARB RECEIVER. Continuous coverage 195 thru 9050 kcs., operates on 24 v. **EXCELLENT USED \$19.95**
DM-34 with conversion instructions to put above set on 12 v. operation. **\$3.25**
DU-1 LOOP. 12 or 24 v. Makes direction finder of above or any other receiver. 195 to 1600 kcs. Easily modified to tune marine freqs. Includes 2 stage pre-amplifier. Sense circuit gives correct bearing immediately. **BRAND NEW \$27.50**
WATERPROOF NAVY BULKHEAD HI-FI PM SPEAKER. With universal matching transformer. 25 w. Very heavy magnet. Ideal for outdoor installations. **EXCELLENT USED \$14.95**
Remote control box, remote tuner, flexible shaft, and plugs. For ARB receiver. **SPECIAL \$10.95**
AN/ARC-5 TRANSMITTER SET. 30 watts. Small control box is all you need in cabin. Consists of 4 transmitters, each 2-1-3 mc., push-pull modulator; all racks, mounts, control and relay boxes; plugs and microphone, 24 v. input, VFO, crystal calibrated. With schematic. **EXCELLENT USED \$64.50** (We can modify above to crystal control or 12 v. operation, or both. Write for prices.)
BC-223-AX TRANSMITTER. 15 watts. brand new. With used 12 v. dynamotor PE-55, connecting cable, 4 crystals, and microphone. **SPECIAL \$79.50**

FLASH! EXCLUSIVE!

WE KNEW IT WAS COMING! WE HAVE IT
 special custom made modulation driver xformer for amazing rig Pg. 50 June RADIO NEWS. Full class A, not class B substitute. Good up to and including kilowatt. 2500 rms insulation. YES, YOU CAN REBUILD YOUR RIG. ONLY \$7.95... A REAL SCOOP WE'RE PROUD OF!

THE HOTTEST 10 METER SPECIALS!

BC-923 RECEIVER. 4 channel. Auto. or manual tuning. 27-38.9 MC, AM or FM. Self contained spkr. Double super circuit. Contains xtal calibrated heterodyne type freq. meter, check points every 100 and 1000 kcs. With complete instructions for rewinding 3 of the 4 channels for complete coverage 27-150 mc., AC power instructions. **EXCELLENT USED.** Each checked and guaranteed OK before shipping.
WITH 12 v. DYNAMOTOR \$27.50
LESS DYNAMOTOR \$24.50
BC-924 TRANSMITTER. 30 watts, FM. 4 channel. VFO; crystal calibrated by above receiver. With schematic. **EXCELLENT USED.**
WITH 12 v. DYNAMOTOR \$27.50
LESS DYNAMOTOR \$24.50
BC-684 TRANSMITTER. 30 watts, FM. 27-38.9 MC. 10 channels push button selection. **GOOD USED, LESS DYNAMOTOR.**
WITH 50 TO 80 CRYSTALS \$34.50
LESS CRYSTALS \$27.50

CATHODE RAY TUBE SPECIALS

7BP7	\$3.95	3EP1/1806P1	\$3.75
5CP1	2.75	3FP7	0.98
5BP4	2.75	3HP7	0.98
5GP1/5BP1 XXX	1.75	3DP1	0.98
5FP7	1.29		

ASB-7 Indicator. Excellent foundation for test scope. Contains 5BP1 and many smaller tubes. With schematic. **EXCELLENT USED \$12.95**
ASB-7 XMTR. **EXCELLENT USED \$3.95**
SPECIAL! BC-458. As is. **\$3.95**
BC-459. As is. **4.95**
BD-71 6 trunk telephone switchboard with head and chest set and ringer.
NEW, EXPORT PACKED \$17.50 USED \$12.95
BD-72 12 trunk switchboard. **GOOD. USED \$17.95**
EE-8 Field phones for above. **GOOD. USED \$7.95**
W-1108 Brand New wire for above.
PER MILE \$22.50 PER FOOT 1c
SCR-625 MAGNETIC MINE DETECTOR. Excellent for locating buried pipes or finding lost valuables. With BA-38 battery.
BRAND NEW, export packed \$39.50
EXCELLENT USED \$29.50
RA-34 Rectifier for BC-375-E, BC-191, input 115 or 230 v., 60 cy., outputs 1000 v. 350 MA and 12 v., 3.2 A, both filtered; plus 12 v. 14.5 amp. AC.
FIXED OUTPUTS, NO METERS \$59.50
VARIABLE OUTPUTS, WITH METERS \$85.00
6" Heavy Duty PM speakers. **NEW! SPECIAL \$1.89**
Tuning units for BC-375. **GOOD. USED \$1.95**
BC-306 ANTENNA LOADING UNITS. **98c**
MAST SECTIONS, 38 1/4" long. Screw together. Extend as long as you like. **EACH 35c**
RG-7U 95 ohm cable. **NEW. PER FOOT 5 1/2c**
No. 20 Stranded Tinned Copper push back wire. 18 50 ft. rolls, each roll different color. **\$7.95**
 Please remit with order. Calif. buyers, please add sales tax.

G. L. ELECTRONICS
 1260 S. Alvarado St., Los Angeles 6, Cal.

Manufacturers' Literature

Readers are asked to write directly to the manufacturer for the literature. By mentioning RADIO & TELEVISION NEWS, the issue and page, and enclosing the proper amount, when indicated, delay will be prevented.

PRECISION RESISTOR DATA

A helpful new Engineering Bulletin R-3, issued by the *Shallcross Manufacturing Company*, Collingdale, Pa., contains descriptions of forty-seven standard *Shallcross* Akra-Ohm precision types, including types designed for JAN R-93 specifications.

The many mounting styles and other adaptations in which resistor types are made by *Shallcross* are shown in the booklet, and it includes, as well, data on factors such as time versus temperature, temperature coefficient, and wire sizes and alloys.

Another feature, of particular value to resistor users making equipment for the government services, is a complete chart showing essential rating and characteristic features of seventeen *Shallcross* Akra-Ohm types for JAN R-93 specifications.

TAPPING MACHINE BULLETIN

A bulletin containing full descriptions of the No. 72 *Ettco-Emrick* Foot-Operated Tapping Machine has been published by the *Ettco Tool Company*, 594 Johnson Ave., Brooklyn 6, N. Y.

The booklet, No. 72, contains a full description of the machine and its operation and enumerates results obtained on actual production jobs. It shows, as well, a table of models and capacities available, complete with a price list.

This literature will be supplied free of charge to all those requesting it, direct from the manufacturer.

CARFONE BROCHURE

An eight-page booklet recently issued by the *RCA Engineering Products Department* describes the company's new 152-174 megacycle FM mobile communications equipment, called "Carfone."

The so-called "31-circuit selectivity" of the new product is explained. Also itemized in the brochure are other features, specifications, and test and performance data of this equipment, the first in the mobile communications field specifically designed for adjacent channel operation.

Copies of the text (Form 2J4626) which is amply illustrated with photographs, schematic diagrams, graphs, and line drawings, may be had from the Communications Section, *Radio Corporation of America*, Camden, New Jersey.

MERIT NO. 4911

Listing all television transformers incorporated into the company's regular line, a new catalogue, No. 4911, has been released by *Merit Coil & Transformer Corp.*, 4427 N. Clark

Street, Chicago 40, Illinois. Each TV replacement is heavily starred for quick identification, and the booklet is indexed both numerically and by classifications on the same page for quick and easy reference.

Other essential new items are shown in the 1949 line, including a complete series of transformers for outdoor sound as well as universal line units meeting the new RMA Constant 70.7V line standards. The various models and mountings are listed at the top of the pages, and then are graphically illustrated at the bottom, with half-tone reproductions.

The catalogue is available to all those interested, distributors and users.

TIMING CATALOGUE

The Haydon Manufacturing Company, Incorporated, Torrington, Connecticut, a subsidiary of *General Time Corporation*, is offering a twenty-page catalogue entitled "Haydon Timing Motors and Devices."

The booklet, printed in two colors, presents the company's line of synchronous timing motors and timing devices, such as battery charger timers, control clocks, defroster timers and elapsed time indicators, as well as interval timers, radio alarms, reset timers, running time meters, and time delay timers. For easy reference, a page is devoted to each item, and separate sections of the catalogue are designed to keep associated units under separate easy-to-find headings.

Complete details on the products are made available, including photographs and profile drawings of all units. Shown also are shaft drawings and listings of speeds, voltages, frequencies, shaft sizes, and special variations available in each of ten motor series.

Design engineers and purchasing agents who can use this listing for reference are asked to address Mr. E. B. Hamlin at the above address.

400 ITEM LISTING

Standard Transformer Corporation, 3580 Elston Avenue, Chicago 18, Ill., has published a 1949 edition of the *Stancor* catalogue, which will include detailed electrical and physical specifications and prices of more than 400 items manufactured by the company.

Among the products manufactured by the corporation and which are included in the listing are audio and power transformers, chokes, and related components for radio, television, and other electronic applications. Besides the descriptions, helpful charts show listings of transmitting and rectifier tubes, driver-modulator combi-

Here It Is! . . .

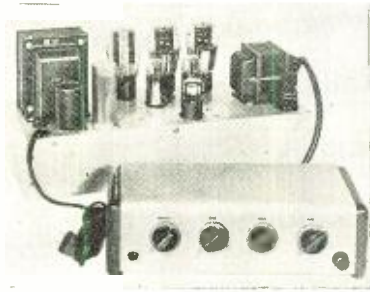

**... THE NEW BROOK
10 WATT AMPLIFIER**

Yes, this is it—a genuine Brook High Quality Amplifier in the moderate price field. An amplifier of incomparable performance . . . equalling Brook 30-watt models in all respects.

Use of triodes in all stages—together with Brook-designed transformers, permits cleanest amplification ever achieved. Distortion is reduced to the vanishing point.

No matter how discriminating you are, this new Brook All-Triode Amplifier will surpass your most exacting expectations. Hear this finest of amplifiers at your dealer's NOW!

Write TODAY For Free Copy of Technical Bulletin and Detailed Distortion Analysis

BROOK ELECTRONICS, Inc.

Dept. RG-9 34 DeHart Place
Elizabeth 2, New Jersey

**Eliminate
TV ANTENNA Problems
Before Installation...**

SPECIFY

VIDI-MASTER

The NEW VIDI-MASTER Models 73, 74 & 88, TV antennas, used singly or in combination, provide ghost-free performance and adequate signal level to the outer edge of the fringe area.

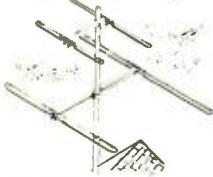

An entirely NEW, yet proven TV antenna design. Ultimate control of interference. Highest possible degree of sensitivity.

Write today for FREE BOOKLET containing complete information on performance, proper antenna selection and prices.



**COMMUNICATION MEASUREMENTS
LABORATORY, INC.**

120 GREENWICH ST. • NEW YORK 6, N. Y.
Cable Address: "COMMUNILAB" New York

July, 1949

nations, matched power supplies, output transformer-tube combinations, and detailed dimensional drawings of all the Stancor transformer mounting styles.

This catalogue is available at the radio parts distributors of Stancor products without charge, or may be procured direct from the manufacturer.

RELAY GUIDE

A new "Quick Guide" catalogue has been produced by Struthers-Dunn, Inc., 150 N. 13th St., Philadelphia, Pa., which contains a simplified listing of essential data to permit easy selection from the many relay types manufactured by this company, and is available free of charge.

Types listed include power relays, small relays, sensitive relays, latch relays with electric reset, sequence relays, instrument controlled relays, special purpose relays, and timers. These are classified according to their functions, and the data is arranged so that it becomes a simple matter to select the type with suitable characteristics for a great majority of applications.

In addition, a section of the catalogue is devoted to the numerous adaptations available in these standard relay types, and another section includes comprehensive data on relay mounting styles, covers, and housings.

MOTOR CONTROL UNIT CATALOGUE

Servo-Tek Products Company, 4 Godwin Avenue, Paterson 1, New Jersey, has made available a four-page color brochure describing its new electronic motor control unit.

The catalogue is completely illustrated and includes details on the operation of the unit and complete information on its uses. The booklet is available on request from manufacturers who may require a smooth, stepless variable speed motor control unit.

-30-

NAB DISTRICT MEETINGS

THE 1949 series of district meetings for the seventeen districts of the National Association of Broadcasters has been scheduled to begin September 8 in Cincinnati and end December 20 in San Francisco.

The meetings are to be workshop sessions, featuring discussions of operating problems, with special emphasis on sales. Full details are still to be worked out with the district directors, but all will be designed for station personnel and will cover local needs.

A number of state association meetings have been planned to coincide with the NAB schedule. Non-members will be invited to attend the NAB sessions at the discretion of the district directors.

A schedule has been arranged to allow staff directors attending to spend additional time in the larger cities in order to work with local broadcasters and to assist in contacting non-members to increase the membership of the association. NAB President Justin Miller is expected to be present at some of the meetings.

-30-

Play Safe!
Use Reliable
**TELEVISION
REPLACEMENTS**

Television requires the most durable, heat-and-moisture-resistant components you can get. In capacitors, that means Sprague. You'll have no profitless call-backs with extra-dependable Sprague TV capacitors.

**SPRAGUE
TELECAP[®]
MOLDED TUBULARS**



Only Telecaps are molded in heat-resistant Bakelite phenolic, oil-impregnated, and then solder-sealed—just like metal-encased oil-paper

capacitors. No other manufacturer can make this claim! Ratings from 600 to 10,000 volts.

**SPRAGUE
ATOM[®] and
TWIST-LOK[®]
DRY ELECTROLYTICS**



The most complete line of television electrolytics. Engineered especially for tough TV replacement applications, Sprague's new Type TVA Atom and Type TVL Twist-Lok electrolytics stand up under the extremely high temperatures, high ripple currents and high surge voltages encountered in TV receivers.

Write for Sprague Bulletin M-429

SPRAGUE PRODUCTS CO.
(Distributors' Division of the Sprague Electric Co.)
NORTH ADAMS, MASS.

★Trademark

123

"Repair a fine Watch with a Shoe? Horn?"



Of course not! Any more than you would rely on your old, outmoded Test Equipment for handling Television Repair jobs.

Quality for profitable TV Repairs with the latest and best at tremendous savings

with a

"Surprise"

TRADE-IN ALLOWANCE on your used, factory-built Test Instruments for BRAND NEW, BIG-NAME TV TEST EQUIPMENT

Choose from Hickok, RCA, Dumont, Precision, Simpson, Triplett, Supreme, Silver, Sylvania, Jackson and all other leading makes.

REMEMBER...

receiving far more for your used equipment means paying much less for the new! Cash in now on the bigger-than-ever "Surprise" allowances offered by Walter Ashe. Get your trade-in deal working today. Wire, write, phone or use the handy coupon below.

Walter Ashe
RADIO CO.
"Test Equipment Headquarters"
1125 PINE ST. ST. LOUIS 1, MO.
PHONE Chestnut 1125

Walter Ashe Radio Co.
O. H. Kettler, Mgr. Test Equip. Div.
1125 Pine St., St. Louis 1, Mo. RN-49-7b

Rush bigger-than-ever "Surprise" Trade-In Allowance on my.....
(describe used instrument)

for.....
(make, model new TV Test Equipment)

Send big Free Catalog of TV Test Instruments.

NAME.....
ADDRESS.....
CITY..... ZONE..... STATE.....

Mac's Service Shop

(Continued from page 40)

calendar and offers to put it up himself—in the best possible place, naturally! The guys were trying to tell that he wanted to hang one right in front of Judge Mull's bench, so that the judge would have to peep around it to see the jury!"

"What do the fellows think about radio advertising?"

"George is the only one who has tried it, and he says it is good, but tricky. Last month the radio station's advertising department fixed him up with one of those *if-your-radio-is-noisy-let-us-take-the-noise-out-of-it-for-you* spot announcements, and George said the results were amazing. The trouble was, though, that people wanted the summer static taken out of their sets! George said he took quite a beating on that, for he had to explain it was not that kind of noise he meant; but he turned the whole thing to his advantage by making several FM sales that would cure the static. From now on, though, he is going to weigh every word that goes into those commercials.

"Lots of other points were brought up. Everyone said they used gummed stickers to go on the backs of repaired sets; and we all confessed that we carefully peeled off the other guy's sticker before we put on our own! Bob, whose store is on the main stem, told us about building a bean-sorting, electric-eye 'crowd-stopper' and putting it in his window. It brought him a nice increase in business and also a writeup in the local newspaper.

"That started us riding Archie again about his knack of getting advertising

for free.' Remember when his kid won the soapbox derby in front of the largest crowd the town has even seen, and the name painted on the winning car was 'Archie's Radio Service'? Remember how that name loomed up in the front-page newspaper picture? Then there was the time when he took those fine pictures of the ice-jam and let the newspaper use them on the condition that they give the shop a credit line. That made the front page, too. We decided that the rest of us could follow Archie's example by using our hobbies to get us some free publicity."

"Fine!" Barney agreed enthusiastically. "Now take my hobby of collecting blondes: we could have a bathing beauty contest, and Margie could be 'Miss Mac's Radio Service Shop.' With me for a judge, how could she lose?"

Mac's only comment on the idea was to clutch his nose firmly between thumb and fore-finger.

"Before we broke up," he went on, "we decided that it was all wrong to think that advertising was only a method of taking business away from one another. Good advertising can actually make business. You know how often people will put up with noisy volume controls, slipping dial cords, weak reception, and so on, until the set breaks completely down. The right kind of advertising could persuade the people to bring these sets in and have these nuisances taken care of at once. Bob Lowe hit the nail squarely on the head when he quoted Derby Brown at the Atlanta Town Meeting:

"The business that considers itself immune to the necessity for advertising sooner or later finds itself immune to business."

-30-

AUTO RADIO CONVERSION TO A. C.

By HOWARD OGUSHWITZ

THERE are a great many automobile radio sets lying around idle which could, with a simple conversion, be used as additional sets in the home, operating from 117 volt power lines.

The original conversion problem, off-hand, seemed to present only two alternatives. The first was to use a converter for dropping 117 volts a.c. to 6 volts d.c. and running this directly into the set. This had two disadvantages: one, vibrator hum would be excessive in a quiet home and, two, the cost of the converter for the particular set in question would run to about \$35.00. The second alternative was to build a complete a.c. power supply, disconnect the vibrator pack in the set, and run the necessary wires in. This would do away with the vibrator hum, but because the cost of the transformer, filter condensers, choke, etc., would add up to approximately \$15.00, the idea was discarded as still too expensive.

After giving further thought to the problem, an idea presented itself, which would not only simplify the conversion, but reduce the actual cost of replacement parts. It was necessary only to run the proper a.c. voltage to the primary of the vibrator transformer, light the tubes with the proper filament

voltage, and the conversion was completed.

Referring to Fig. 1, note that a low-cost filament transformer was used to convert the power line voltage to 6 v. a.c. which is applied to one-half of the primary of the original vibrator transformer in the set. The original vibrator was removed and its associated wiring was removed or bypassed.

-30-

Fig. 1.

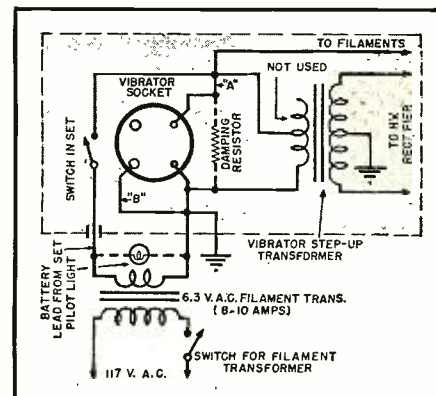

THE "ALL PURPOSE" TELEVISION KIT

10" 12 1/2" 15"



FEATURING

- Latest Type of Circuits
- AGC—Automatic Gain Control
- Picture and Sound Automatically Locked
- Sound Cannot Drift
- Non-Microphonic
- Stagger Tuned I.F. for Max. Gain and Ease of Alignment
- 12 Channel Tuner
- Electromagnetic Focus and Deflection
- Automatic Stabilized Synchro-Lock Circuit Holds Picture Steady
- Voltage Regulated Circuit for Stability

Large clarified stage by stage pictures and schematics to insure ease of construction. Guaranteed to work. Money Back Guarantee—Buy it, inspect it, if you don't think it's the best buy on the market—return unused within 5 days and your money will be refunded. All prices F.O.B. New York. 20% deposit with order. IMMEDIATE DELIVERY

SOVEREIGN TELEVISION CO.
5508 New Utrecht Ave.
Bklyn 19, N. Y.

GREYLOCK RADIO TUBE BARGAINS!

GT. Glass and Miniature Types

1R5	6AT6	12SA7	} 34 1/2¢ ea. in 100 lots
1S5	6BA6	12SJ7GT	
174	6BE6	12SK7	
104	6SA7GT	12SQ7	
304	6SJ7GT	25Z6GT	
354	6SK7GT	25L6GT	

SPECIAL OFFER! All above types may be purchased in lots of 100 assorted, at \$34.50 per 100. Also available in smaller quantities at 39¢ each.

6AK5	6BG6	69CG	69C
6AG5	1B3-9016	89C	
6J6	2E24	\$1.89	

All tubes in individual cartons
TERMS: Not C.O.D., F.O.B. NYC. MINIMUM ORDER \$5.00.
Write for Bargain Catalog N-7
Greylock Electronics Supply Co.
30 Church Street New York 7, N. Y.

CODE SENDING RECEIVING SPEED

Free Book

HIGH SPEED WITHOUT NERVOUS TENSION

REVEALING BOOK shows how "crack" operators develop high speed and proficiency. Learn code for Amateur or Commercial Radiotelegraph License, or improve your sending and receiving with the Chandler System which develops radiotelegraph experts and code champions.

CHANDLER SYSTEM Box 928, Dept. 2-H Denver, Colorado

Television's Impact

(Continued from page 31)

technical developments in the field of television promise a vast improvement in the quality of the sets and an extension of the service it will render to its owner. Component parts production, new patents, the streamlining of manufacturing methods all have tended to reduce the cost of the television set for John Q. Consumer.

The installation problem, too, is being rapidly eliminated. Inside antennas have achieved a remarkably high degree of efficiency. Consequently, such limiting factors as lack of space for an outside antenna or the objections of a landlord to the placing of an antenna on the roof of a building, or the high cost of installation, have been partially eliminated.

Television engineers and technicians not only foresee cheaper sets, simpler construction, but within a short time, color! It was not too long ago that the Columbia Broadcasting system was thwarted in its attempt to secure band allocations for color. This was a mechanical color technique and the Federal Communications Commission felt it was not in the best interests of all concerned to tie up part of the band with mechanical color when some day electronic color transmission could be achieved. Today, electronic color reproduction is being perfected, and plans are under way for its commercial use.

Another outstanding new development has just been announced by a television set manufacturer. H. C. Bonfig, vice president of *Zenith Radio Corporation*, says that Phonevision, a method of so coding a television transmission that a set owner cannot tune in a clear picture until he receives the help of a special decoding signal that comes into his home over the telephone wire, will supplement free television, just as the phonograph record supplements free radio. It is felt that Phonevision will make television sets possible in small cities that could not possibly support them by advertising alone. As yet this has not appeared commercially, and if its proponents can protect it from the native American ingenuity which might develop a fifteen-cent gadget to unscramble the signal, this should be of positive benefit to the manufacturer as well as the viewing public.

With Phonevision, the television viewer will have to call the telephone operator for the signal and then tune the station in the usual way. For this service he will be charged a fee, which will be divided by the television transmitter, the telephone company, and the movie producer or entrepreneur who provides the program. The idea behind this is that set owners who wish to see any new movies will pay for them just as music lovers now pay for phonograph records.

From the advertiser's point of view,

SAVE \$ ON RADIO SURPLUS

TRANSMITTING FILTER CHOKES

63 Henries .018 Amp. 930 Ohms.95c

CONDENSERS

CCA 2 MFD. 1000V (4 3/4" x 3 1/4" x 3 1/2") \$1.75
CCA 8 MFD. 1000V (7" x 6" x 4 3/4") 2.25
DUB 1 MFD. 3000V (5" x 7 3/4" x 2 1/2") 1.25
PARADON .125 MFD. 500V. 2 Amps. @ 39 K.C. (5 7/8" x 5 1/2" x 4") 1.00

.00005 MFD. 2500 W. V. D.C. Trans. Mica35c
MIDGET CABINET—8 1/8" Lx5 7/8" Hx4 1/4" D. Asst. Colors. Holes for Vol. Control & Var. Cond. Center Speaker. 69c

Signal Corps Phones—2 M. Ohms (8M Imp.) \$1.25
2 Ft. Extension Cord (Female Plug) 40c

OIL FILLED FILTER CONDENSERS

1.—MFD—2000 volts95c ea.
1.—MFD—1000 working volts. 4 for \$1.00

FAMOUS BRAND RECORD CUTTING HEAD

Size 1 3/8 x 2 1/8 ready to fit your cutting arm or bracket. SPECIAL \$2.95

TOBE TUBULAR ELECTROLYTICS

20-20 MFD. 150 V. .29c 40-40-20 MFD.38c
40-40 MFD. 150 V. .37c 150 V.38c
30-30 MFD. 150 V. .32c

2 1/2 M.H. R.F. CHOKE COIL—27c ea. 5 for \$1.00
3 BAND OVAL DIAL—7 1/2" L x 5 1/2" H.79c
100 RESISTOR ASST. 1/4-1/2-1 WATT95c

Low-Loss Short Wave Variable Condensers

1/2" Shaft Type20c
5 Plate—20 MMFD20c
14 Plate—55-60 MMFD27c

Lock Type Air Trimmer Variable Condensers
3 Plate—12-15 MMFD.10c
5 Plate—20 MMFD.11c
8 Plate—30-35 MMFD.13c
10 Plate—40 MMFD.14c
14 Plate—50 MMFD.20c
20 Plate—80-100 MMFD.25c
27 Plate—100-110 MMFD.35c

3 GANG T.R.F. VARIABLE CON. D.E.S.E. 3 \$2.95
000365 Cap. 95c
D.P.D.T. SLIDE TOGGLE23c
SWITCH39c

4 PR. WAFER SOCKETS—\$1.49 per C. each.3c
PHILCO 4 MF—300 V—1 1/2" CAN CONDENSER—\$8.00 ea. \$10.00
W-L—10 W. 1,000 ohm Power Rheostat.49c
5-6 PRONG WAFER SOCKETS. \$2.50 per C

100 ASST. SOCKETS—4-5-6-7. \$3.50 per C
1.000 OHM WIRE WOUND RHEOSTAT.49c
30 HY-FILTER CHOKE SHIELDED.49c
UNSHIELDED39c

100 ERIE—4 WATT—2,000 OHM RESIS. \$1.15
10 WIRE WOUND RES. KIT—5-50 W. ASST.49c
2,000 ohm Wire Wound Rheostats. \$1 per doz.
CARTER WIRE WOUND C.T. VARIABLE 20 OHM RESISTOR \$1.00 per doz.

G. E. TAPPED VOLTAGE DIVIDER—\$1.00 per doz.
230 OHM—MOUNTED ON ASBESTOS BASE—TAPPED AT 180-205 ohms.25c
RCA 6 OHM POWER RHEOSTATS49c
PHILCO AUTO SUPPRESSORS—\$5.00 per C.7c ea.
GEN. ELEC. WESTINGHOUSE, etc. 60 CYCLE WATT HOUR METERS, slightly used, perfect condition, same as used in your home. 110-125 volts. 5 Ampere. \$3.50 10 Amps. \$4.50

Philco rotary tap tone control.25c
I. C. A. 30 MH RF choke.25c

Grind your own crystals—Pure Brazilian Quartz, all sizes and thicknesses—1/2 lb. package. \$1.00
340—degree dial with 10 push button attachment—1/4" shaft—ideal for Xmitters—Sig. Gen. or Osc.39c

RCA Band Switches—
3 gang, 3 posit., 3 band.30c
6 gang, 5 posit., 4-5 band.40c

Trimmer-Padder Asst.—all isolantite—singles, dual, triples—100 asst. pieces. \$2.25
5"—450 ohm AC-DC dynamic. \$1.35
5" 5M OHM RCA SPEAKER. 1.00

ATTENTION: Prospectors

Explorers for Hidden Treasures!
Do you seek hidden treasures of rare metallic ores? Do so, construct a U.S. Army Type of Metallic Mine Detector from these U.S. Army Prospectors Amplifiers that we are offering at a ridiculously low price. Amplifier unit only (less tubes and batteries), with cables, headphones and Jack (no phones). Complete Army wiring diagram. U.S. Army DETECTOR SET Amplifier Type AN/PR-1. \$1.95
No. C.O.D. Everywhere. 45 volt batteries 2—\$2.175 ea. 6 volt A. 73c. 2-1N5 tubes.95c ea.

TUBES—024—79c; 53—39c; 2A7—39c; 55—39c; 117L—89c; 27—25c; #15, same as #224—20c; 01A—25c; 31—20c; 85—25c.

DRY ELEC. FILTER COND. ASST. CONTAINS 10 PIECES ALL BRAND NEW 150-450V. \$1.10
6 ASST. WET ELECTROLYTIC CONDENSERS.59c

RADIO EXPERIMENTER'S SURPRISE PACKAGE—CONTAINS BYPASS & FILTER CONDENSERS, SHORT WAVE TUNING UNITS, POWER AND AUDIO TRANSFORMERS SOCKETS, RESISTORS, CHASSIS HARDWARE, OVER 20 LBS. OF VALUABLE PARTS. \$4.95

DRILLED CHASSIS FOR 5-8 tubes 7" x 10" x 1 1/2" —29c; 5" x 10" x 1 1/2"25c
RCA ADJUSTABLE CODE INTERFERENCE WAVE TRAP 450-475 K.C. & CLOSED AUTOMATIC PHONE JACKS—OPEN & CLOSED AUTOMATIC TYPE18c
NATIONAL 5-15-450 VOLT CAN FILTER CONDENSER39c
EBY SPEAKER VOL. CONTROL—60 OHMS.25c

SALE—PHONO RECORD ALBUMS—SALE
10"—3 comp.—15c; 4 comp.—20c; 12 comp.—49c
12"—3 comp.—15c; 4 comp.—20c; 12 comp.—69c

JONES 20 TERMINAL BARRIER TYPE STRIP.95c
BC-654A TRANSMITTER & RECEIVER, Only 10 Sets Available. SPECIAL \$15.00

W. E. S. T. E. R. N. ELEC. TRANSMITTING STEP-DOWN TRANSFORMER—AC. 190 210, 230, 250 V. W.E. 20 AMP REPAIR CHOKE TO MATCH. Wt. 1.25 lbs. ea. Freight Shipments Only. SPECIAL. \$5.00 ea.

MINIMUM ORDER \$2.00—NO C.O.D. SHIPMENTS—PLEASE INCLUDE POSTAGE

NEWARK SURPLUS MATERIALS CO.
Dept. JY
324 Plane Street NEWARK 1, N. J.

RADAR, COMMUNICATIONS AND SONAR TECHNICIANS W-A-N-T-E-D For Overseas Assignments

Technical Qualifications:

1. At least 3 years practical experience in installation and maintenance.
2. Navy veterans ETM 1/c or higher.
3. Army veterans TECH/SGT or higher.

Personal Qualifications:

1. Age over 22—must pass physical examination.
2. Ability to assume responsibility.
3. Must stand thorough character investigation.
4. Willing to go overseas for 1 year.

Base pay, Bonus, Living Allowance, Vacation add-up to \$7,000.00 per year. Permanent connection with company possible.

Apply by Writing to
**D-4, P.O. Box 3575,
Philadelphia 22, Pa.**

Men qualified in RADAR, COMMUNICATIONS or SONAR give complete history. Interview will be arranged for successful applicants.

television brings the realization of a dream. At last he can take his product into the consumer's home and demonstrate it under actual working conditions. Not only can he use his voice as a selling tool, but he also has use of the potent vehicle of pictures. In television the advertiser has all the combined advantages of newspapers, magazines, radio and billboards.

Advertisers use the various media to accomplish certain specific jobs. The billboard, for instance, is designed primarily to get one brief selling point across. The magazine ad generally is designed to create interest in a product and soften buyer resistance. It tells what the product is, and why it should be purchased. Newspapers are a more immediate form of advertising which emphasizes the nature of the product and states that it is available now for so much at such and such a place. Few advertisers attempt to conduct an entire campaign in any one medium because they understand that the buyer must first have his attention drawn to the product; his interest aroused, and, finally, must be motivated to action—to buy.

Thus it is easy to see that advertising technique heretofore was generally a process of leading the buyer through the various processes of attention, interest, conviction, and action to the point of sale. Generally this campaign began with a national magazine which told about the product and created interest in it. It was followed by the local merchant's mention of the item in his newspaper ad, where he didn't discuss the product generally but was more specific as to size, color, quality, and price, and stated where it could be purchased. And, finally, when the prospect has reached the point of purchase, the salesman must step into the picture and consummate the sale.

Television can considerably eliminate many of the steps that have been necessary for the sale of merchandise, because television offers an opportunity to accomplish immediately what the other medias have been unable to do in one operation—get the prospective individual's attention where he can see the merchandise, see how it looks, see it in use, hear the selling points about it, learn the price, and find where it can be bought immediately. Because of this, it is possible to foresee a complete change in our advertising and even our means of communication. Up to now, no medium has been able to do the job for the retail store that the newspaper has been doing.

Although retail advertisers valued the mass audience attention gained through radio advertising, most of them used radio sparingly because their product had to be shown, had to be illustrated, and all the talk in the world wouldn't convince Mrs. Jones that a Sunday bonnet or kitchen table was exactly the way the announcer described on the radio. Now she doesn't have to depend on her imagina-

tion. She can see the table, visualize how it fits into her kitchen, note its construction, see close-ups of the finish and texture and get the selling message at the same time. She has been brought past the stage of the magazine and of the newspaper, because she has all the information at once and has been brought to the point where she doesn't actually have to go into the store at all but can pick up the telephone and order the merchandise desired.

This has far-reaching implications. It means, first, that much buying will be done by remote-control via the telephone or a newly-devised blank that will be prepared and sent by direct mail to television set owners by the merchandiser or store. This, in turn, will limit the amount of space run in newspapers. Since the newspapers depend greatly on advertising for revenue, it is conceivable that we may soon find newspapers assuming a different form and approach in order to continue to exist.

The cost of living will be greatly reduced by lowering the cost of retail merchandising through the use of television. For example, let us assume that a store is gearing itself to present all of its vast majority of merchandise via television. It is entirely conceivable and within the range of possibility that the store need not be visited—that the store, as we know it now, will be replaced by a series of decentralized warehouses. Since they would be serviced by fewer clerks, and overhead costs, lighting and heating, etc., would be reduced, the merchandise could be sold for less money. Of course, this is a long range picture, but it offers an idea of how television can affect our very mode of living, our economic system, our every-day habits . . . our personal lives.

It has often been said in political discussions that one of the best ways to break through the "Iron Curtain" and secure the friendship of the Russian people would be to bombard them with *Sears Roebuck* catalogues. The reason for this statement is the simple logic that if a desire for goods and merchandise is created where this desire has not existed before, people will be so intent upon developing these goods, they will not think of war, but rather of working peaceably with the western world to develop a living standard and foreign trade which might secure these things.

This is human nature. As human beings, we are imbued with certain amounts of inertia, laziness, and a lack of interest in what is going on around us. And so Mrs. Jones, who saw the kitchen table on her television set, sees many other things. She sees, for instance, how much easier it is to use modern kitchen appliances in her everyday home-making; the correct way to apply make-up to make herself more beautiful and attractive for her family; to properly prepare table-settings and special dishes for parties and social engagements; and

LEARN

Electricity OR Radio-Television

IN THE GREAT
SHOPS OF COYNE

COYNE 50th ANNIVERSARY
TRAIN QUICKLY!
OLDEST, BEST EQUIPPED
SCHOOL of ITS KIND in U.S.
2 Opportunity Fields

Come to the Great Shops of COYNE in Chicago during our 50th Anniversary Year! Get quick, practical training in RADIO-TELEVISION or ELECTRICITY. G I Approved. Finance plan for non-veterans. Mail Coupon Today for complete details.

NOT "HOME-STUDY" COURSES!
You learn on real, full-size equipment, not by mail. Finest staff of trained instructors to help you get ready quickly for a better job, a fine future.

FREE BOOKS Clip coupon for big illustrated Coyne book on either ELECTRICITY or RADIO-TELEVISION. Both books sent FREE if you wish. No obligation; no salesman will call. Act NOW!

B. W. COOKE, Pres.
COYNE Electrical & Radio School, Dept. B9-85H
500 S. Paulina Street, Chicago 12, Illinois

Send FREE BOOK and full details on:
 ELECTRICITY RADIO-TELEVISION

NAME.....

ADDRESS.....

CITY..... STATE.....

to understand the value of interior decoration, home planning, and design. Is it any wonder, then, that Mrs. Jones becomes more enlightened and transfers that enlightenment to her children and friends? When this situation becomes general, we have attained an increased standard of living. Television is capable of overcoming human frailties and bringing the "mountain to Mohammed." Once interest has been aroused, curiosity stimulated, and lessons visibly proved, the pump has been primed, action has begun, more goods and merchandise are bought, more money flows, and we have a prosperous economy.

Just as our economy will be affected, so will be our personal tastes. Even family life will be influenced by the advent of television. Throughout the nation there is a rustle of renewed activities—rehearsal halls are being dusted and vaudeville acts are being rejuvenated. Visual entertainment in all its forms is again coming into its own. Vaudeville, operettas, and the musical revue will be brought to the masses and no longer limited to Broadway or the Rialtos of the few larger cities.

In addition, other forms of literature, music, and American folk lore are being written for visual presentation. With the combination of motion picture film and the television camera, coupled with the television receiver in the American home, John Q. America is about to receive the greatest treasury of enlightenment and education that has ever before been given to a free man. His responsibility will be to use it wisely and to transmit this tremendous technical achievement into one of world wide blessing.

POLISHING TV LENSES

BY MAX ALTH

PLASTIC, oil-filled television lenses should never be wiped off with a dry cloth, but should always be cleaned with lukewarm water. Do not use any soap or cleansing compound.

The dust found in every home contains a percentage of grit, and when this is wiped off by an over-zealous housewife, it acts as an abrasive which, in time, causes a fog to develop on the surface from the minute scratches.

When these fine scratches have dimmed the lens, jewelers' rouge can be used to repolish the surface. The deeper scratches will have to remain, however, as this fine rouge will not cut the plastic down to that depth.

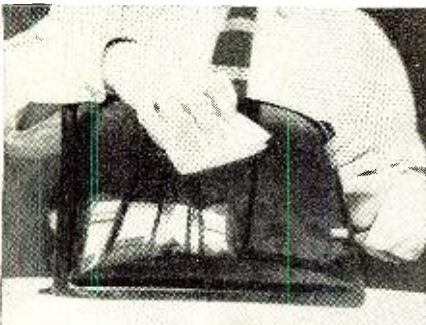

IMPERIAL MODEL

NOTHING
LIKE IT
IN TV!

PIONEERS IN PROJECTION TELEVISION

SPELLMAN TELEVISION CO., INC.

DEPT. A, 130 WEST 24th STREET, NEW YORK 11, N. Y. • AL 5-3680

New All-Triode 10W Hi-Fi Amplifier Kit!

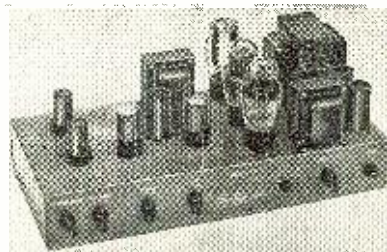

SUN RADIO AMPLIFIER, MODEL CR-10

Build This High-Quality, All-Triode, Self-Biased, High-Fidelity Amplifier For Only **\$42.50**

From the design published by Consumers Research, Inc., of Washington, N. J.

Brilliant amplifier for use with FM/AM tuners and changers. Compare these specifications! **Freq. Response:** 20-15,000 c.p.s. ± 1 db. Built-in pre-amplifier and equalizer for use with magnetic cartridges. **Hum level:** 60-70 db. below rated output at radio input. **Distortion:** less than 2.5% at 10 watts; 2.5% at mid-frequencies at 11.8 watts. **Gain:** radio, 75 db.; phono, 97 db.; magnetic pickup, 117 db. at 50 c.p.s. Complete with all 7 tubes, components, punched chassis, hardware, etc., and simplified step-by-step instructions. Order now!

Laboratory-wired and tested..... **\$69.50**

SUN RADIO
AND ELECTRONICS COMPANY, INC.
122-124 DUANE STREET
New York 7, N. Y. BARclay 7-1840
2 BLOCKS NORTH OF CHAMBERS ST.

IN A CLASS BY ITSELF!

3 x 4 FEET

12 SQUARE FEET

OF BRILLIANT, CRYSTAL-CLEAR PROJECTED PICTURE!!

Here is absolutely the brightest, sharpest, clearest GIANT image in television today! No dim or fuzzy pictures... can be viewed under any light conditions... perfect side angles—a new triumph in projection television achievement!

Features include giant 14-inch Schmidt Mirror in solid cast housing plus exclusive Regulated Power Supply and Automatic Cutout Relay for tube protection. Remote control operation.

DISTRIBUTORS and DEALERS now being appointed. Don't delay—Wire, Phone, Write today for full information. Be the first to tie-in with this new money-maker!

AIRCRAFT RADIOS

ART/13 Complete, Tested, Guaranteed, \$240.00. Used xmitr only \$79.50.
SCR 522, NEW, complete with all plugs, J boxes, manual, and dynamotor, \$85.00. Transceiver only, \$40.00. Dynamotor only, \$5.00. Antenna, \$1.00.
BC 348 Reconditioned, tested, guaranteed, complete, \$125.00. Receiver only (no -Q or -R), \$79.50.
ARN/7 or BC 433G Radio compass units, complete with manual and all component parts, \$65.00. Inverter for above 149G, \$25.00. (See us for all component parts, new.) BK 22K relay, \$3.00; Plugs, \$1.50 ea.; MC 124 Tuning Cable .015 per inch, Control Boxes, \$7.50 and \$5.00, used, with back P/P 224, Loop LP21A \$5.00 new.
ITALIA Transceiver, new, Receiver, less rack, \$500.00.
AVT/23 RCA 25 Watt transmitter, new, \$112.50.
APS/13 Tail radar units (good on 460 MC), \$10.00.
TA-12 Bendix 100 Watt (new) transmitter, \$45.00.

PLUGS and hard to get items all new

ART/13, all plugs, set, \$15.00; BC 348 plug, \$1.50.
ARN/7 or 133-G Plugs, set, \$5.00 (includes inverter plug); PL 112, 118, or PL 122, individually, \$1.50. Command set, Plugs, receiver, or xmitr, any 3 for \$1.00.
Right angle drives for Command sets, 75c; Flex. tuning shafts, 13' long, \$1.00; PL 55 Phone plug, 39c; PL 68, JK 26, PL 54 or Phone Jacks, 25c each; SCR 522 plugs, set of 16, complete, \$20.00; any single plug, \$1.50 each; Co-ax Plug 250A, 35c, or 4 at \$1.00.

ACCESSORIES

Earphones HS 33 or 38 with headband (new), \$2.00. Same, export packed with rubber cushions, \$3.75.
BC 348 Q IF unit (Part 191), new, \$2.00.
Slug tuning inductances (new) for SCR 522, a set.
Item at 10c each (minimum order, \$1.00).
Airplane switches, any type, S/P, 35c; D/PST, 50c; D/PDT, 75c; Micro switches, 75c.
Jewell Lights, can be dimmed by turning. Colors: Red, Amber, Green, Yellow. Any 5 for \$1.00.
1042-6A Eclipse voltage regulator, new \$15.00.

DYNAMOTORS—New original cartons
DM 33A, \$1.50; DM 34, \$4.50; DM 35 (12 volt), \$10.00; PE 73, \$5.00; PE 94, \$5.00; PE 118, \$10.00; DM 32, \$4.50; PE 206, \$5.00.

TELEPHONES

EES Field Phone, \$7.50, canvas, used; Leather New, \$15.00; Western Electric 5-bar Generator wood call box and French hand type Phone, used, very good at \$7.50 each; Call box or ringer, only \$4.00; TS-13 Hand set, \$4.50. Ideal shack-to-house rig for the XYL.

FARWEST TRADING CO., Inc.

209 1st Ave. South Seattle 4, Wash.

W7XQV

(We do not issue catalogues)

here is an ideal

**PORTABLE
microphone
stand**

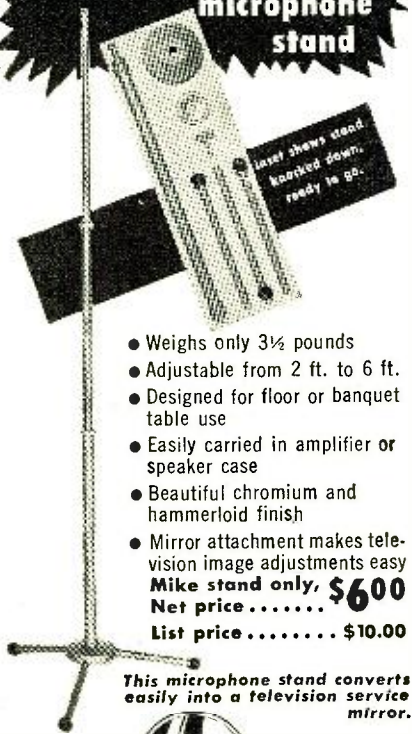

- Weighs only 3½ pounds
 - Adjustable from 2 ft. to 6 ft.
 - Designed for floor or banquet table use
 - Easily carried in amplifier or speaker case
 - Beautiful chromium and hammerloid finish
 - Mirror attachment makes television image adjustments easy
- Mike stand only, \$600**
Net price \$600
List price \$10.00

This microphone stand converts easily into a television service mirror.



All you need to do is unscrew the microphone fitting and attach the mirror. Sketch shows the mirror—on its own stand—being used to adjust the image from the rear of a console set. The mirror gives the technician a front view of the image while he is making adjustments from the back.

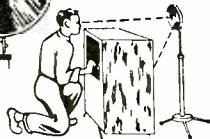

Net price \$195
List price \$3.25

See your local distributor or write
NETTLES MANUFACTURING CO.
1237 16th St. Denver 2, Colo.

**IT DOESN'T TAKE A
Master TO BUILD
TECH-MASTER**

De-Luxe 630 TV Kit
Genuine RCA 630 TS Circuit



Only
168.50
Complete Kit
Less Kinescope

Tech-Master builds faster. Comes 98% assembled. A few enjoyable evenings to finish the job—plug it in and there's your picture! And remember, with our own patented conversion bracket, Tech-Master is readily adaptable to 10, 12, 12½, 15 and 16 inch tubes! Start on the way to pleasure and profit. See Tech-Master today! At leading jobber's everywhere. Write for nearest jobber.

MASTER PRODUCTS CO.
Way, Dept. N-7, New York 13

LETTERS

from our readers

FREQUENCY RESERVATIONS, YET

IN REGARD to an article written by Marvin Gurlin in the April issue, I confess I have had thoughts along that line. For myself, I am only trying to learn the code, and believe me, it is tough.

"I have tried to pick up the station called W1AW at 3555, and just about the time I find it, all hell breaks loose from the other station. It would be a wonderful thing if we could have code lessons starting right from the beginning, on a frequency where we could listen and concentrate.

"Your articles on the 'Beginning Amateur' are swell. It's really the best thing I've seen yet, and I'm anxious to be a licensed amateur. But I do need more code practice, and I sincerely hope you can help us fellows."

Bernard A. Heinle
3305 Westchester Rd.
Toledo 6, Ohio

The idea of a "beginner's frequency" is a new angle, and it might not be too bad at that.

GOT ANY BONERS TO TELL?

HERE is a suggestion for a new department for RADIO & TELEVISION NEWS which should make some good reading, provide for more reader participation in the magazine, and steer others away from the mistakes that have been made. I have in mind a department in which the readers tell of the horrible boners they have pulled in servicing, constructing, or otherwise. I suggest no special name for it, because, if you should decide to have such a department and call for suggestions, the readers would give you plenty to pick from.

"To start things off, here's a real boner of my own:

"I had designed what was to be a high-gain, high-fidelity recording and playback amplifier. Finishing the construction late at night, I ran off a few silent tests (which looked good) and decided to wait until morning for the speaker tests, lest I awaken the whole household. I put the amplifier in its cabinet, closed the cover, listened for hum, installed knobs and some hardware, and then went to bed, neglecting, however, to turn the amplifier off.

"The next morning it was well warmed up, so I decided to try it out with a record, with the most horrible results I have ever obtained. The gain seemed to be very close to zero, the quality of what output there was could be compared to nothing good I have ever heard, and with the volume turned wide open as it must be, there was a fairly low frequency howl much

louder than anything else that came out.

"Suspecting mechanical feedback and interference as the cause of the howl, I used better shock-mounting for the chassis and turntable. I fastened parts, such as blocking condensers, so they would have to be pried loose. I tested tubes and connections, shields, and grounds. I changed needles, and I changed speakers. Finally, I wound up rebuilding the amplifier, with more shielding, more and better bypassing in the 'B plus' circuit, more rigid mounting of everything that shouldn't bounce, and rubber shock mounting of several tubes. After this I got no more howl or mechanical vibration at full volume, but I got very little of anything else, and what there was of that was as bad as ever.

"Then, I did what I should have done at first: I started testing every part from record to speaker, whether it was suspected or not. I didn't have far to go. I had tried needles. Next in line was the crystal pickup, and it was the guilty one."

"The explanation was that I had left the cover down the first night and had not provided proper ventilation, so that the temperature exceeded the maximum 120° F. which a crystal of this type cannot stand without serious damage. This was one of the first things I should have suspected if I had connected conditions with consequences; but, not so doing, I learned a good lesson. Now, when a piece of equipment doesn't work properly, and the cause is not soon evident, I start testing everything from input to output, whether it looks guilty or not.

"Thank you for your consideration of my suggestion and contribution.

"An old reader"

E. J. Dobbie
Oilmont, Montana

Well, OM, that's certainly a good suggestion you've got there, and many thanks for the story of your construction difficulty. It should keep someone else from that pitfall. To get back to the idea of the department—we can't have any stories without storytellers. Let's hear from some of you other experimenters.

CODE FOR CODE'S SAKE

I AM heartily in accord with the views expressed by Messrs. Dietz, Gurlin and Wolfe on code and certainly approve anything that will bring back to amateur radio the fascination of radio, or as we oldtimers knew it, 'wireless'; code.

"Somehow or other, the telegraph code is a means of introduction by air

RADIO & TELEVISION NEWS

TECHNICAL KO's

SPECIAL: 10% discount on orders of \$5 or more, if 3 or more items are ordered.

OIL FILLED CONDENSERS		TRANSMITTING MICAS	
.05 MFD 1000 V	\$0.35	.00005 2500 V	\$0.15
.1 2500 V	.75	.00005 3000 V	.35
.1 7500 V	1.65	.00005 5000 V	.85
2x.1 7000 V	4.10	.000067 2500 V	.20
.12 15000 V	7.95	.00025 5000 V	.85
.25 1000 V	.35	.0005 2500 V	.25
.25 4000 V	2.15	.00072 5000 V	.85
.25 6000 V	3.75	.0008 5000 V	.85
10x.25 600 V	1.05	.002 1000 V	.20
.5 600 V	.28	.002 3000 V	.65
.5 1000 V	.40	.003 2500 V	.30
.5 2000 V	.75	.003 3000 V	.65
.75 2000 V	.60	.004 2500 V	.35
.77 330 VAC	.30	.005 1000 T.V.	.15
1.0 1000 V	.45	.005 3000 V	.65
2.0 200 V	.30	.006 2000 V	.35
2.0 600 V	.40	.008 1200 V	.15
2.0 1000 V	.60	.01 1000 T.V.	.15
4.0 600 V	.60		
4.0 1000 V	1.00		
5.0 220 VAC	.75		
6.0 1500 V	1.45		
8.0 600 V	.85		
8.0 1000 V	1.75		
10.0 600 V	1.00		
30.0 90 VAC	1.40		
30.0 330 VAC	3.75		
25.0 Electrolytic 25 V	.40		
100.0 Electrolytic 25 V	.50		

TELEVISION

BOOSTER—Your Troubles Are Over With Our High Gain Unit—Channels 1-13 in a Beautiful Mahogany Cabinet.....\$24.95

300 Ohm twin lead-100 Ft.....1.75

72 Ohm co-axial cable-100 Ft.....4.50

Standoff ins. 3"-300 Ohm or co-ax......06

Expansion Bolts 1/4"x3"......09

Carboloy Drill 3/8"-5/16".....1.65

3/4" Friction Tape 1/2 lb. Roll......35

\$2.00 min. order F.O.B., N.Y.C. Add postage 50% deposit, balance C.O.D. with all orders. Manufacturers' inquiries invited. Send for Flyer. Prices are subject to change without notice.

TECHNICAL RADIO PARTS CO.

Moved to Larger Quarters
557 McDonald Ave. Dept. RNT14 Brooklyn 18, N. Y.

WE ARE LOOKING FOR TUBES!

WHAT HAVE YOU GOT?

Interested in small or large quantities of all types of Transmitting, Industrial, and Receiving Tubes. Send offerings to:

Send your list to:
MOHAWK ELECTRONICS CO.
160-N GREENWICH ST., NEW YORK 6, N. Y.

LEARN RADIO!

PREPARE FOR A GOOD JOB!
BROADCAST ENGINEER
COMMERCIAL OPERATOR (CODE)
RADIO SERVICEMAN

Television Servicing

(Approved for Veterans)
SEND FOR FREE LITERATURE
BALTIMORE TECHNICAL INSTITUTE
1425 EUTAW PLACE, BALT. 17, MD.

for mutual understanding and fellowship. It is a common bond by which we can exchange intelligence, even though we cannot speak each others' languages.

"Code has many advantages; from a commercial standpoint as well as from that of the amateur or military. The knowledge of code can serve as a useful tool of expression in emergencies.

"As a kid of 15, I learned both the International and American Morse codes; as Mr. Dietz says, the 'light' came from practice. With a mill at high speed, I earned my living for many years in the communications field of Morse and radio-telegraph. The knowledge of high-speed telegraph opened to me the field of fascinating news events, hours before it became public news. I hold a commercial 2nd class radio license of 1929 vintage, and I am a paid up member of the Order of Railway Telegraphers, and an ex-train dispatcher; I also sailed as a wireless operator aboard American vessels. (I wonder if there are any of the old gang around?)

"During the past few years, I was telegrapher for the Boston Record news channel from the World Series games last year, and served as a newspaper telegrapher for the National Air Races, football games, etc.

"Newspapers, brokerage houses, Western Union, postal and railroad systems, as well as the oil pipe lines all have called upon our profession. From a stick, pen and ink, mecograph or mill, with a book or 10 on a line, there is nothing to compare with the enchantment of code, for real enjoyment."

W. H. Corbett, W8DVP
11808 Phillips Ave., N.E.
Cleveland 8, Ohio

Yours is the romantic point of view, and you're right! Those who take the trouble to learn the code and use it to communicate with their fellow enthusiasts will know what you mean.

NEW LIGHT ON TOUGHER EXAMS

SEVERAL years ago, there was considerable agitation for a special radio amateur license, restricted to ultra-high-frequency and super-high-frequency bands, with no code requirements. So far, the plan has gotten nowhere.

"I understand that the regular amateurs are opposed. The FCC is partly guided by their opinions. Also, the government wants to have as many people as possible learn the code, and rightly so. Just the same, I believe that the restricted license would be a good thing for all concerned.

"A lot of people are interested solely in the technical side of radio as a hobby. For instance, I'd rather set up an ultra-high-frequency transmitter and plot its field in the 'shadow' of a hill, than talk to any, or every, ham station in Asia. Two-way communication seems worthwhile to me only when the other fellow isn't near

SURPLUS

BRAND NEW TUBES

304 TLea.	\$.90
Four for	3.00
5 BP1ea.	1.95
5 BP4ea.	2.95

SMASH VALUES IN COMMAND EQUIPMENT

BC-453E.X.C.	\$12.95
BC-454E.X.C.	NEW 7.95
BC-455E.X.C.	7.95
BC-456NEW	2.95
BC-458NEW	7.95
BC-459E.X.C.	9.95
BC-696E.X.C.	14.95

CONDENSERS

2 MFD. 4000V. Pyranol	\$2.95 ea.
4 for	\$10.00
2 MFD. 5000V.	\$3.95 ea.
6 for	\$20.00
.25 MFD. 15-50V.	\$5.95 ea.

R-89/AR-50A

Slide path receiver. Crystal control of local oscillator, 332-338MC, complete with relays, 7-8A5J, 1C-125K7, 2-125N7, 1-25D7 and 3 xtals; 6497, KC-6522 KC, 6547 KC, 90 cyc. band pass and 150 cyc. band pass filters, excellent for making an intermediate checker. Beautiful cabinet and chassis as foundation for many interesting experimental and construction projects. Broad pass band on 20.7 MC. IP's ideal for television. Schematic furnished. Used, excellent, less covers. Only \$12.95

BC-733-D Freq. Range: 108 to 112 Mc. New \$9.95

BC-620 TRANSMITTER-RECEIVER UNIT
FM transmitter-receiver, crystal controlled, two channels, freq. range 20-27.9 mc. 13 tubes, dual meter for testing filament and plate circuits. Used, good \$9.95

MOBILE INSTALLATION KIT
for BC-659 or BC-620
Consists of TS-13, MP-48; 4 section whip antenna; insulators; 2 maintenance manuals. NEW \$12.95

BC-684 27.0-38.9 FM TRANSMITTER
Same as above except for freq. range. New \$24.95
FOB Chicago only

RECEIVER-AMPLIFIER
Contains the following circuits: Blocking oscillator, C.R.T. gate circuit, Azimuth and Vertical sweep circuit. 5 stage 30Mc. IF strip with AFC circuit. Tube complement: 6-6SN7GT, 2-6V8GT, 6-6AG7, 2-6L6GT, 8-6AC7, 2-6H6, 1-2050, 1-884. Used, excellent condition \$14.95

EE-8 ARMY FIELD TELEPHONE
Sturdy, highest quality telephone at less than price of a better-class toy. With ringer. Requires only two flashlight batteries for each phone and two wires between each phone. Excellent condition. Used, Each \$7.95

VERTICAL ANTENNA
1/2 wave vertical dipole antenna, complete with 36 inch whip, 36 inch skirt, 7 ft. aluminum pole, mounting brackets and 3 ft. of coaxial cable with PL-259 plug \$12.95

APQ-2 RADAR TRANSMITTER
200 to 500 MC—Used, good condition.....\$7.95

APQ-9 RADAR TRANSMITTER
500 to 600 MC—Used, good condition.....\$7.95

VHF TRANSCEIVER
Ideal substitute for SCR-522, freq. range 140-144 mc. crystal controlled, 10 watts. The receiver section has two individual RF sections, feeding a common 3 stage 10mc IF amplifier. Both RF sections may be operated simultaneously, or either one individually. The receiver unit has 13 tubes. The transmitter is of straight forward design. Transmitter unit has 7 tubes, one #832 as final modulated by a pair of 6L6 and push-pull. Complete unit in case with tubes, crystals and diagram less dynamotor. EXCELLENT CONDITION.....\$14.95
New Phantom Antenna for above unit. 3 lamps in parallel with sockets, complete for.....95c

ALTIMETER TRANSCEIVER RT-3/ARN-1
Frequency 418-462 mc. FM with 14 tubes including 3-12S47, 4-12SH7, 2-12H6, 1-VR150, 2-955, 2-9004, 24v Dynamotor, used. \$4.95
in working condition.....

SPECIAL!
WESTINGHOUSE TRANSMITTER BC-122
Freq. range 325 to 800 KC; in portable field case; 3 meters plus excellent parts (less tubes)—An Excellent Buy—BRAND NEW \$7.95 ea.

NEW CATALOG
Listing Many Surplus Values.
Write for Your FREE Copy Today!

All shipments FOB Chicago or Los Angeles unless specified. 20% Deposit required on all orders. Minimum order accepted—\$5.00. California and Illinois residents, please add regular sales tax to your remittance.

ARROW SALES, INC., DEPT. N
Main Office: 1712-14 S. Michigan Ave.
Chicago 5, Illinois
North Side Branch: 1802 N. Humboldt Blvd.
Chicago 47, Illinois
West Coast Branch: 1260 S. Alvarado
Los Angeles, Calif.

SURPLUS BARGAINS

RECVR. & XMITTER

N E W BC-454 (3-6mc. Rcvr & your choice of either a 274X or ARC-5 4-5.3mc. or 5.3-7mc. Xmitr (slightly used)

BOTH FOR **\$895**



#C 459, 7 to 9.1 mc. (new)	14.95
720 ARC 5, 4 to 5.3 mc.	11.95
722 ARC 5, 7 to 9.1 mc.	11.95
#C 454 7-9.1 mc. (used)	12.95
722/ARC-5 7-9.1 mc. (new)	12.95
(Used)	3.25
720/ARC-5 4.5-5.3 (used)	4.95
274-N Type Trans. 2.1-3 mc. (used)	7.95
BC 453 190-550 kc. (used)	7.95
#C 454 3-6 mc. (new)	12.95
(Used)	3.25
#C 455 6-9.1 mc. (used)	4.95
274-N Type Receiver 1.5-3 mc. (new)	15.95
(Used)	7.95
12 volt Dynamotor (can be used for above)	
ARB Recvr 190-9.05 mc. continuous (exc. for marine) (used)	19.95
ARB CONTROL BOX (Single or Double Type) BRAND NEW	1.49
ARN-7/BC 433 Recvr 150-1750 kc. continuous (used)	14.95
ASB/7 Indicator Unit with Tubes (exc. basic unit for 5" scope) (used)	14.95
Spare set of 4 tubes Command Recvr or Trans. Specify which set.	1.25
Dynamotor, 6 volts DC-300 volts DC 85 ma.	2.45
BC 375 Tuning Unit, New	2.45

SELSYN XMITTER & INDICATOR



Ideal as Radio beam position indicator for Ham, Television or commercial use. Complete with I-82... **\$595**

SCR-522 TRANS. & REC.

With Case & all Tubes. Like New... **\$39.50**

FILAMENT TRANSFORMERS—110 volt 60 cycle primary.

12-24 volt at 2 amp. **\$ 2.95**

5-24-30 volt at 20 amp. **3.95**

6.3 volt at 5 amp.—5 volt at 3 amp.—33 volt at 150 ma. **1.95**

PLATE TRANSFORMERS—115 volt 60 cycle primary.

3200 volts NO CENTER TAP—NEW

Two (2) used SINGLE PHASE FULL WAVE RECTIFIER CIRCUIT give 2900 volts WITH 300 ma. LOAD. **6.95**

2 for. **15.95**

540 C.T. @ 150 ma.; 5 volts @ 3 amp.; 6.3 volt @ 3 amp. **3.95**

880 C.T. @ 150 ma.; 6.3 volt @ 4.5 amp.; 1.7 volt @ 5 amp. **4.95**

HEINEMAN CIRCUIT BREAKERS

120 volts @ 10 amperes. **.89**

120 volts @ 20 amperes. **1.95**

FL-8 Audio Filter (new). **1.79**

Add 40c for postage.

DC Ammeter 60-0-60 (new). **.97**

FILTER CONDENSERS OIL FILLED

2 mfd. @ 600 volts, 3 for. **\$.49**

10 mfd. @ 600 volts, 3 for. **1.19**

1 mfd. @ 1000 volts, 3 for. **.49**

8 mfd. @ 2000 volts. **2.39**

8 mfd. @ 2500 volts. **2.95**

1 mfd. @ 3600 volts. **2.95**

1 mfd. @ 4000 volts. **3.49**

2 mfd. @ 4000 volts. **4.95**

3 mfd. @ 4000 volts. **5.95**

2 mfd. @ 5000 volts. **5.95**

EE-8 FIELD PHONES

Headset, generator, ring, etc. All in case. Fine for Garage extensions. Installation work, etc. PHONES TESTED BEFORE SHIPMENT. Used in excellent condition. **\$15.95** per pair, **\$8.95** each. Remittance with Order. Minimum Order **\$2.50**. Orders F.O.B. Los Angeles, Calif. Prices Subject to Change without Notice.

ESEGE SALES CO. LTD.

Distributors of Surplus Radio and Electronic Parts

1306 Bond Street at Pico

Los Angeles 15, Calif.

CIRCUIT ALIGNED COMPONENTS!

Proved the only satisfactory method for Quality Results.

TECH-MASTER

de-luxe 630-TV KIT
GENUINE RCA 630-TS CIRCUIT

Only

168.50

Complete Kit
Less Kinescope

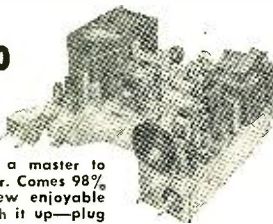

It doesn't take a master to build Tech-Master. Comes 98% assembled. A few enjoyable evenings to finish it up—plug in and there's your picture.

Several jobber's territories still open—Write

TECH-MASTER PRODUCTS CO.

Way, Dept. N-7, New York 13

a telephone. Perhaps I should set aside one or two hundred hours and get that 13 word code speed, but that much time spent on a technique that doesn't interest me, and that I'd never use, seems wrong for a hobby. If I spent the same time studying, say electromagnetic field equations, it would be fun, and the information would be useful.

"Amateurs would have a right to complain if there were any crowding on the high bands, but everyone knows there's room for all. If the exam were made tougher, and it should be, there would be enough room for a long time. And as far as the interests of the government go, aren't high-frequency technicians as useful as low-frequency communications experts?"

"If RADIO AND TELEVISION NEWS agrees with these ideas, a little action, along with your excellent drive for more regular amateurs, would help considerably."

Sayre Rodman
Oakmont, Allegheny County
Pennsylvania

Between high code speed and low code speed, it was bad enough. Now, here's an advocate of "no code." The point is well taken, however; there may be more operators than we know about who are interested only in the technicalities of radio.

* * *

EVERY VOTE HELPS

AS AN old timer in ham radio, and also one of the pioneers of the 160 meter band, I for one would like to see the return of the whole band to amateurs.

I am also in favor of a return of the code speed examination to 10 w.p.m.

V. P. Baughn
1411 Lagonda Ave.
Springfield, Ohio

Short, but direct. You know your own mind, V. P.

—30—

TV SET OUTPUT AT NEW PEAK

IN a recent report by the Radio Manufacturers Association, it was announced that television set production by RMA member-manufacturers reached new records during the first quarter of 1949.

In March, the manufacture of TV sets reached a total of 182,361, and the combined figure for the first quarter was 422,537. This is a new high over the previous record of 161,179 reached in December of 1948; March and December were five-week work months. TV set production by RMA members was 121,238 in January, and in February, 118,938.

Breaking down the March figure to a weekly estimate, the average weekly production was 36,472, which represented an increase of nearly 23 per cent over the weekly average in February. The quarterly output of TV receivers this year was three and one-half times that of the first quarter in 1948.

—30—

STOP! LOOK!

A New
T. V. Kit
BY



of
Wash., D. C.
2413 Pa.
Ave. N. W.

The Kit consists of the following:

- A Complete Drilled and Punched Chassis
- 13 CHANNEL TUNER (mounted on chassis)
- All component parts made and fully guaranteed by leading mfrs.
- Complete simplified step by step wiring procedure & diagrams makes it easy to assemble
- Prices for these Kits are amazingly low:
 - 7" complete with tubes \$99.50 (less c.r.f.)
 - 10" complete with tubes \$139.50 (less c.r.f.)
 - 12" complete with tubes also 12ip7 \$199.50

Write today for full particulars

BLUE GRASS BUYS

805 Tubes—Splendid Modulators **\$395**
Surplus—New

12-Tube Servo Amplifier #2CVIC1. Full of Resistors—Sockets—Condensers. Also Shock Mount Chassis 11¼ x 11¼ **\$195** with Cover. Made by G.E.

Stancor No. A—3808 Mod. Trans. Used **2.95**

Stancor No. C—1721 Choke. Used **1.69**

Stancor No. P—1325 Trans. Used **2.69**

RADIO EQUIPMENT CO.

DEPT. LD, 480 SKAIN ST., LEXINGTON, KY.

ATTENTION Amateurs-Experimenters-Inventors

Cut your cost on radio supplies and equipment in half. Clip coupon today.

Hundreds of "hard to get" war surplus items along with the best in standard brand equipment—all at great savings to you. Let us know your particular requirements. IMMEDIATE DELIVERY.

PLEASE PUT MY NAME ON YOUR MAILING LIST FOR SPECIAL BULLETINS.

NAME
ADDRESS ZONE
CITY STATE

NIAGARA RADIO SUPPLY CORP.

160 N. Greenwich St., New York City 6, N.Y.

Mass. Radio School

273 Huntington Ave., Boston 15, Mass.

Offers Training Courses for Radio Technician (Pre-Television) and Licensed Radio Operator (All Types) including maintenance and operation of General Electronic Equipment. Over 20,000 Alumni and 30 years radio training EXPERIENCE. Courses approved for Training for Veterans.

Send for Catalog

Licensed by Commonwealth of Mass.
Department of Education

SURPLUS HIGH SPEED DRILLS MICROMETERS

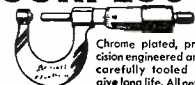

Chrome plated, precision engineered and carefully tested to give long life. All new.

0-1" capacity . . . each **\$2.25**

1-2" capacity . . . each **3.50**

2-3" capacity . . . each **5.50**

3-4" capacity . . . each **6.50**



All New Drills! Orig. value \$15.

30 assorted sizes and lengths \$3.50

SEND FOR FREE DESCRIPTIVE CATALOG

Send check, money order or cash. 25% deposit required on C. O. D. orders. All prices F.O.B. Culver City, Calif.

AIRBORNE SALES CO., INC. DEPT. 2111
CULVER CITY, CALIF.

RADIO & TELEVISION NEWS

Microwave Spectroscopy

(Continued from page 29)

is the 1 centimeter wave guide ($\frac{1}{2}$ " x $\frac{1}{4}$ " rectangular tubing) at left top utilizing a Raytheon RK33 tube. Absorption of a given frequency of an incoming microwave signal by gas such as an ammonia vapor is revealed on the oscilloscope or recorder as a relatively sudden intensity drop, representing a spectral line. For sensitive detection of spectral lines, the Bureau also employs a Stark absorption cell (the larger wave guide 3" x $1\frac{1}{2}$ " shown below the $\frac{1}{2}$ " x $\frac{1}{4}$ " wave guide system) in which an electric field is used to modulate a wave traversing the cell by electrically shifting the frequency of the spectral line back and forth. Extremities support the Stark ribbon inside the larger guide. Heavy or deuterated ammonia is used inside the wave guide absorption cells to extend the frequency coverage below that now available with other substances.

A basic setup for microwave spectroscopy may be relatively very modest. It comprises:

1. A source of microwave power. Normally this is a tube feeding directly into a wave guide. Work started with the Western Electric 2K50 reflex oscillator. When production of that tube ceased after the war and the supply became exhausted, Raytheon developed the reflex klystron types QK140 and QK141 for the region 8 to 11 millimeters. They have also developed the types QK226 and QK227 for the region 5.8 to 8 millimeters where the power output is in the order of 5 milliwatts.

2. A calibrated variable attenuator to control the energy from the tube into the gas cell. Fig. 5 (left) shows a modern type where attenuative material is inserted into the wave guide to provide the degree of attenuation desired. Each thousandth of an inch penetration as controlled by the knob represents one division on the indicator scale. The scale is calibrated against a graph furnished with the instrument.

3. A wavemeter for measurement of the absorbing frequency such as shown in Fig. 5 (right). In the better versions, it is made of invar for the main cavity portion in order to minimize frequency error with temperature change. A silver plated plunger is mounted on the end of a micrometer barrel. The frequency is determined by the use of differential readings on the micrometer between two adjacent signal points. These are referred to calibration tables, one showing differential micrometer reading versus frequency in kilomegacycles, while the other gives the exact frequency in megacycles for each thousandth of an inch in micrometer reading.

4. Various optional items and features including power supply, modula-

Nothing Finer!

CHICAGO FEATHERWEIGHT MULTI-TESTERS

Highest Quality—Chicago "Featherweight" Multi-testers are made with the precision of a fine watch. Strict tolerances provide accuracies far above commercial standards—readings are absolutely dependable.

Most Compact—Chicago "Featherweights" are the smallest multi-testers in the world. They are truly pocket-size instruments, weighing only a few ounces . . . a pleasure to use in or out of the shop.

Lowest Cost—Chicago "Featherweights" guarantee more real usefulness and dependability at considerably lower cost. There is nothing like a "Featherweight" for standing up under hard daily use. They are built to "take it."



Chicago "Featherweights"

<p>Model 450A Volt-Ohm Milliammeter for DC Volts 0-5/10/50/500/1000 Mils 0-1 Ohms Full Scale 5000/50,000/500,000 Ohms Center Scale 30/300/3000 Net price \$10.90</p>	<p>Model 451A Volt-Ohmmeter for AC and DC Volts DC 0-10/50/100/500/1000 Volts AC & Output 0-10/50/100/500/1000 Ohms Full Scale 500,000 Ohms Center Scale 7200 Net price \$14.90</p>
<p>Model 452A High Sensitivity DC Volt-Ohmmeter Volts 0-10/50/100/500/1000 10,000 Ohms per Volt Ohms Full Scale 2000/20,000/200,000/2,000,000 Ohms Center Scale 30/300/3000/30,000 Net price \$14.90</p>	

Chicago

There is a Chicago Multi-Tester for every purpose

Write for our complete catalog

CHICAGO INDUSTRIAL INSTRUMENT CO., 536 W. ELM ST. CHICAGO 10, ILL.

TRADE-INS ARE MY BUSINESS! TELL ME WHAT YOU HAVE AND WHAT YOU'D LIKE TO HAVE. WE CAN MAKE A DEAL!

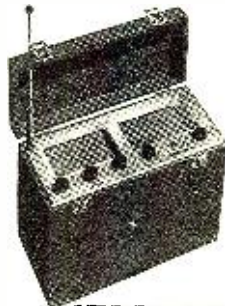

HOW ABOUT THIS NEW S-72 HALLICRAFTERS ALL-WAVE PORTABLE

Super powered. Maximum efficiency on AC, DC or battery. Covers standard broadcast band and 3 short-wave bands—540 KC to 30.5 Mc. 8 tubes plus rectifier. Handsome brown leatherette cabinet with brass plated hardware. Less batteries. Only \$79.95.

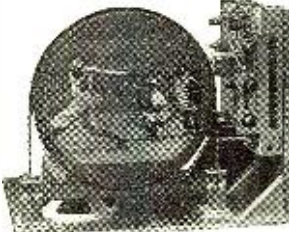

T-69 NEW HALLICRAFTERS 15" TV CHASSIS FOR CUSTOM INSTALLATIONS

Complete with picture tube. Needs only cabinet or mounting place in your wall. Brilliantly lighted. All channel push-button tuning. 8 inch P.M. Speaker included. 19 $\frac{1}{2}$ " x 23" x 21". Here's a custom installation at a real saving in price. Only \$259.50.

Nobody can beat Bob Henry on a trade-in! (I make the deals myself.) Nobody can beat Bob Henry's world's lowest credit terms! (Because I handle it myself.)

Bob Henry gives you immediate delivery on practically anything in the amateur or communications receiver line. (I carry the world's biggest stock.) Bob Henry gives YOU FREE ten-day trial and FREE 90-day service!

These are just some of the reasons why Bob Henry sells more receivers than anyone in the world! EVERYTHING has some trade-in value. Write me what you have and what you want. We can do business!

BOB HENRY WOPARA
COMPLETE STOCK OF ALL HALLICRAFTERS RECEIVERS AND TRANSMITTERS

Write for catalog prices, time sale information



Buller 2, Missouri

HENRY RADIO STORES

11243 Olympic Blvd.
LOS ANGELES 25
CALIF.

WORLD'S LARGEST DISTRIBUTORS OF SHORT WAVE RECEIVERS



Assembled for your convenience
Facts, standards
practices, data
for the whole field
of radio engineering

Radio Engineering Library

RADIO specialists of the McGraw-Hill publications selected the books for this library as those giving the most complete, dependable coverage of facts needed by engineers whose special fields are grounded on radio fundamentals. They cover circuit phenomena, tube theory, networks, measurements, and other subjects... give specialized treatment of all fields of practical design and application.

- ★ Special Low Price
- ★ Bought singly, the five volumes would cost \$30. Under this offer you save \$2.50
- ★ Pay in easy installments

FREE 10 Day Trial!

McGraw-Hill Book Co., 330 W. 42nd St., N.Y.C. 18
 Send me Radio Engineering Library, 5 vols., for 10 days' examination on approval. In 10 days I will send \$2.50, plus few cents postage, and \$5.00 monthly till \$27.50 is paid, or return books.

Name

Address

City..... Zone.... State.....

Company

Position..... RN-7-49
 Books sent on approval in U. S. and Canada only.

Library includes:

1. Fundamentals of Vacuum Tubes—Eastman
 2. Radio Engineering—Terman
 3. Communication Engineering—Everitt
 4. High-Frequency Measurements—Hund
 5. Radio Engineering Handbook—Henney
- 3559 pages!
 2558 illustrations!

tor, crystal assembly with its output feeding into an amplifier and indicating meter as illustrated in Fig. 1 for general microwave laboratory setups not particularly limited to spectroscopy alone. The usual procedure is to take a wave guide section and make it gas tight by using a thin transparent mica seal at its flanges where it joins the adjacent plumbing section. Suitable fitting is provided to connect to a glass piping system for evacuation, inserting pressure, insertion and removal of samples, etc.

Fig. 4 is a map of the United States showing the principal activities and locations of the Atomic Energy program, together with their associated universities. Microwave spectroscopy is taking place at such activities as the Gaseous Diffusion Plant at Oak Ridge, Tennessee (Fig. 6) and the Brookhaven National Laboratory at former Camp Upton on Long Island. At Brookhaven National Laboratory, Dr. Victor W. Cohen heads the Nuclear Moment Laboratory where work is going on with microwave spectroscopy to study nuclear spins within the molecule. Fig. 7 shows a spectral line with the base line protuberances (two at each end). These are typical of phenomena under study for nuclear spins or moments. One of these studies is with the element Sulphur 32 as compared to the radioactive element Sulphur 35. The difference of three in its nuclear makeup accounting for its radioactivity is under study by means of microwave spectroscopy.

The art of microwave spectroscopy started out with a combination of home-made components except where they could be made up from commercial sources manufacturing 1 centimeter radar plumbing. One manufacturer was particularly fortunate in having a complete line of 1 centimeter components in regular production postwar as the result of having guessed wrongly as to the direction in which radar and communication frequencies would move. Microwave spectroscopy has been depending on such source for their commercial requirements.

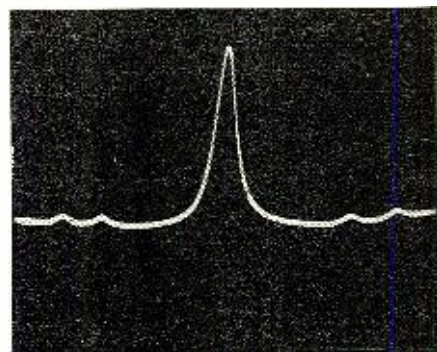

Fig. 7. A typical spectral line with indications of nuclear moments due to the nature of the molecule.

To name a few of the far-reaching applications for microwave spectroscopy as now undertaken or contemplated in various parts of the United States, the author has discovered the following in the course of his investigations during the past six months:

1. A leading oil company is engaging in the analysis of hydrocarbons. Their plan is to determine interatomic distances, molecular structure, molecular flexing, and rotation. They feel some of this phenomena occurs in the microwave region at approximately 50,000 megacycles, which should be possible to determine by shooting microwave energy through gas samples in a wave guide.

2. Dr. W. D. Hershberger of the RCA Laboratories in Princeton, N. J., is attempting frequency stabilization with microwave spectral lines involving use of the absorption frequency of ammonia at 23,780.1 megacycles.

3. Dr. Townes and staff of the Columbia Radiation Laboratory in New York are doing outstanding work in studying the absorption of a large number of elements and compounds. They are developing one of the most complete lists of absorption frequencies to facilitate identification.

4. The Western Regional Research Laboratory of the U. S. Department of Agriculture have a number of plans of attack for their newly acquired microwave spectroscopy equipment. One

Fig. 6. One of the mammoth plants of the Atomic Energy Commission at Oak Ridge, Tennessee, employing microwave spectroscopy to facilitate their work.

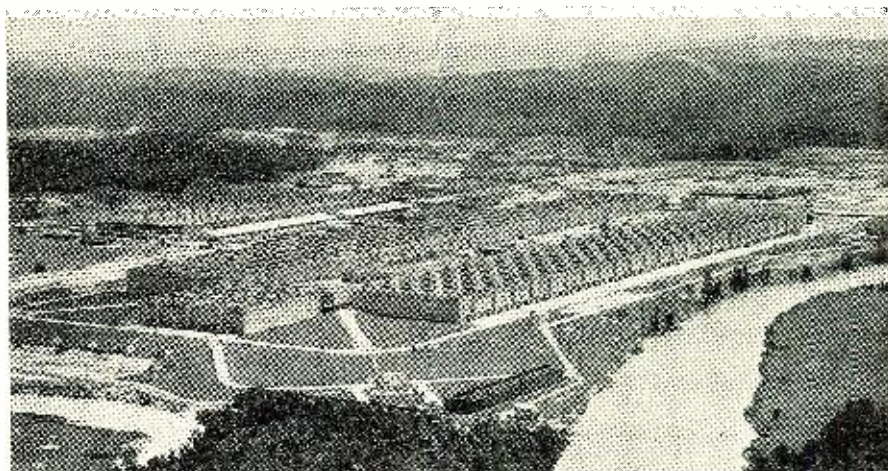

FREE

HOW TO GET THE MOST FROM YOUR RADIO "KNOW-HOW"

Learn all about a new, simplified way of fixing radios. Nothing complex to learn, no calculating. Used by beginners and experts. Send for FREE manual, "THE INSIDE STORY," today. 28 pages—illustrated—easy to read! Shows how obsolete methods prevent full use of your real ability. Explains use of NEW techniques. You owe it to yourself and your future to "get out in front" in your work.



SEND COUPON OR PENNY POSTCARD FOR FREE MANUAL TODAY!

FEILER ENGINEERING CO., Dept. 7H9
 945 George St., Chicago 14, Illinois
 Please RUSH my FREE copy of "The Inside Story"

Name

Address

City..... Zone.... State.....

All-Purpose QUIK-SHOT
Soldering Iron Heats Itself

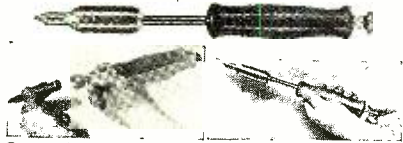

Open tip. Put in cartridge. Pull rod and release. Iron heats up fast.

Cartridge-heated, this iron develops 865°F (300 watts equivalent) in 10 seconds from a cold start. Six interchangeable tip sizes from 3/8" to 1 1/8" can be used on same iron. No breakable parts requiring replacement. All pure copper and steel construction throughout.

EVERY IRON BEARS LIFETIME GUARANTEE!

Revolutionary, first all-purpose soldering iron ever designed. On outdoor antenna work or indoor bench jobs, Quik-Shot performs beyond comparison with conventional irons. See iron at your dealer. If he cannot supply, order direct. Circular on request.

Quik-Shot Iron, with standard 3/8" or 5/8" tip, plus 4 cartridges..... **\$595**

KEMODE MFG. CO.
161 W. 18th St., N. Y. 11
Canada: Atlas Radio Corp.
560 King St. W., Toronto



JOBS IN TELEVISION

YOUNG MEN 16 TO 60

There is a job opening for every qualified trained Television Technician.

WE CAN TRAIN YOU
FREE EMPLOYMENT SERVICE

Visit Our Modern Laboratories and Class Rooms
Approved Under G.I. Bill of Rights

AMERICAN RADIO INSTITUTE

New York, N. Y. 2010 Broadway
Syracuse, N. Y. 131 Shonnard St.
Mt. Vernon, N. Y. Buffalo, N. Y. 640 Main St.
174 Gramatan Ave. 640 Main St.

"Teaching Radio Since 1935"

This is our



ANNIVERSARY!

WE'RE celebrating with you by reducing our package rates up to 12%. Saving to you now up to 104% compared to Express. Various other reductions. Low cost plus service backed by half a century of courteous efficiency. Write today for our new rates.

Freight Forwarders . . . Est. 1899

LIFSCHULTZ
FAST FREIGHT
173 W. Madison • Chicago 2

of their dreams is to analyze the evaporated vapors from strawberries or similar fruits to connect the data with taste and flavor of such agricultural products.

5. Meteorological activities are lining up microwave spectroscopy techniques for lower and upper atmosphere research to determine the concentrations and compositions of the various gaseous elements in air at all levels.

6. Others are using microwave spectroscopy techniques to facilitate their research in the adjacent infrared region.

7. Some speak of the development of a push-button microwave microscope working with molecules of gas, liquids or solids. It is expected to perform many new functions that have been found impossible to do with the electron microscope, x-ray or spectrometers and spectrographs.

In addition to the sources of information mentioned in the text, the author wishes to thank Dr. Walter Gordy of Duke University, Professor Smyth of Princeton University, Professor Gwinn of the University of California at Berkeley, Marks Brook of the University of California at Los Angeles, Dr. D. K. Coles of *Westinghouse Research Laboratories* in East Pittsburgh, Mr. Sharbaugh of the *General Electric Laboratories* in Schenectady and many others. They are all hard at work on this development and making invaluable contributions about which there will be a good deal more to report in the future. It is going to result in many new avenues of opportunity for the radio and electronic technician or engineer. He is becoming very helpful in hitherto little related fields such as food, petroleum, metallurgy, plastics, medicine, and almost every field involving substances made up of molecules of matter in gaseous, liquefied, or solid states. In the modern university today, microwaves have expanded from 10,000 megacycles and below for electrical engineering, to as high as 30,000 megacycles for physics and to 50,000 megacycles and beyond for the chemistry departments. The field of chemistry now becomes the most important field for microwave application in connection with molecular analysis. In universities such as Princeton and University of California at Berkeley, the most advanced microwave developments on the highest frequencies are now in the chemistry department notwithstanding the importance of their electrical engineering and physics departments.

The techniques are sufficiently straightforward as to also be practicable for the radio amateur utilizing his highest assigned frequencies such as 21,000 to 22,000 megacycles or to lone experimenters, since the simplest microwave spectroscope or microscope is a tube and a piece of pipe. Anything more than that makes for precision and refinement.

CHAMPION
OF ALL
ANTENNAS

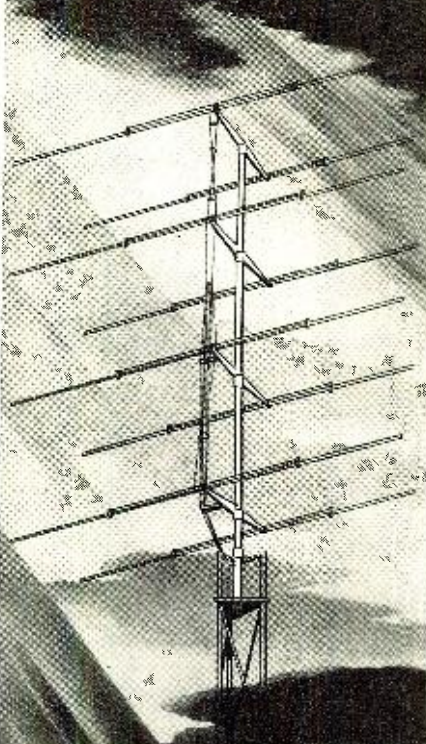

VEE-D-X

holds every record
for LONG DISTANCE
RECEPTION

This is fact -- not fiction. VEE-D-X super high-gain antennas have put good TV reception into thousands of homes where it was thought impractical because of distance. Our own research, and several hundred unsolicited letters from enthusiastic users, provides convincing proof that VEE-D-X means video distance -- and delivers it. For further information, write or mail coupon below.

LaPointe-Plascomold Corp., Unionville, Conn.
Send complete details on Vee-D-X antennas to

Name

Company

Street

City Zone State



In Steel, Aluminum or Monel

The efficiency of Premax Tubular Antennas for marine radio communication has been definitely established through their wide use in pleasure, commercial and government craft. Many types are available in aluminum and monel, each particularly designed to meet certain conditions and maintain efficient communications from ship to shore or between vessels at sea or on inland waters. All are fully telescoping and adjustable and may be had in heights from 6'3" to 35'8" extended length.

Send for the new Premax Marine Antenna Bulletin showing Antennas and Mountings.

PREMAX PRODUCTS DIVISION CHISHOLM-RYDER CO., INC.

4909 Highland Ave., Niagara Falls, N. Y.

RADIO Surplus Buys

COMMAND REC.

Used, good.
BC453—
19 550KC . . . \$12.95
BC454—3-6-MC. . . 5.95
BC455—6-9.1-MC. . . 6.95
6 1/2" CONTROL
CABLE for
above Command
sets 1.00

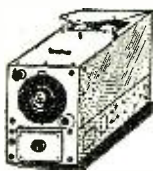

BC603 FM Receiver. Used, good. . . . \$12.95
BC683 FM Receiver. Used, good. . . . 24.95
BC684 FM Transmitter. Used, good. . . 15.95
Mountings FT237-D for 603, 604, 683, 684 7.95
APS-13 Transceiver. New. 17.95
APS-13 Racks. New. 1.00
R5/ARN7 Compass Receiver.
Like New 14.95
BC-433G Compass Receiver.
Like New 14.95
R4-ARR-2 Receiver. Used, good. . . . 10.95

R-1/ARR-1 HOMING RECEIVER

Jan. RADIO NEWS article tells how to convert this receiver to high freq. converter for use with your present receiver. Easily converted, compact, well built. Like new, with 4 acorn tubes and plug. Priced at only \$9.95



Send 25% with Order. Balance C.O.D.
All equipment F.O.B.

C & H SALES CO.

950-C7 East Colorado St., Pasadena 8, Calif.

Classified

Rate 20c per word. Minimum 10 words

RADIO ENGINEERING

SPECIAL instrument panels made for Custom Constructors, Designers. Complete Service. Gilpin, Box 638, Rte. 4, Mt. Clemens, Mich.

RADIO Engineering Broadcasting, Aviation and Police Radio. Servicing, Marine Operating and Electronics taught thoroughly. Expenses low. Write for catalog. Valparaiso Technical Institute, Dept. N., Valparaiso, Ind.

SALE

100 WATT Transmitter, ART 13, completely converted for marine use. Crystals included for 6 channels. 24 to 32 volts DC. Included also, Bendix tunable receiver. Price \$350. A. J. Seamon, 45 Lawrence Pkwy., Tenafly, N. J.

HALLICRAFTERS 7" TV \$110. Dual-speed disc-recorder, complete \$100. Shortwave receiver \$20. Write for particulars. Peter Rosenbaum, 39-21 65th Pl., Woodside, N. Y.

TELEVISION Wiring Diagrams. Set of ten. Only \$1.00 postpaid. Melpro Co., P.O. Box 40, Bay Ridge Station, Brooklyn 20, N. Y.

RECORD Collection. Write for details Ned Fleishman, Box 703, Fayetteville, N. C.

AMP. ACA-100 ADC. Guaranteed, 25 W. Johnston, Box 193, Nogales, Ariz.

RECORD Changer Parts for leading makes of changers. We ship everywhere. Mail orders invited. Friend's Wholesale Distributors, 106 North Sixth St., Philadelphia 6, Pa.

12B8 & 25B8 TUBES, Adapter Unit using 2 miniature tubes (6AT6 & 6BA6 for 12B8, and 12AT6 & 12BA6 for 25B8). Takes less space than original tube—nothing else to buy—just plug in & it works. Money-back guarantee. 12B8 or 25B8 unit complete: \$2.49 each. 10 units for \$22.50. Send 25% deposit, balance C.O.D. Write for free parts catalog. Commercial Radio, 36 Brattle St., Boston, Mass.

GRILL Cloth, Celanese, light and dark pieces. 1000 square inches for \$1 bill. Write for list of lowest priced national brand parts in nation. Bursma Radio, Route 5, Grand Rapids, Mich.

COAXIAL Cable. Identical characteristics as RG-58/U. Send dime for 3-foot sample. Harry H. Van Dick, Box 236, Little Falls, N. J.

COMPLETE sixteen-inch recording equipment, reasonable. E. Bernash, 46 Hillside Ave., Woodlawn, Buffalo 19, N. Y.

WIRE Recorder 70-7,000 cycles. 65 minutes recording with time scale, automatic stop, positive erase. Designed to be used with your present Amplifier without modifications. Portable, self-contained in luggage carrying case. New, guaranteed by Wirecorder of Detroit. Precision performance instrument. Record live F.M. with realism. Complete ready to play with Mike, Spools, Wire, Instructions. \$140.00 less Amplifier. Lester Brown, P. O. Box 1071, Philadelphia 5, Pa.

SPEAKERS. 5000 used 8-inch speakers with line transformer. Suitable for Drive-In Theatres, public address systems, replacements. \$3.00 each. Can be seen in Detroit, Cleveland, Chicago, Milwaukee, Indianapolis, St. Louis, and Kansas City. Write to Arnold Berger, Midwest Drive-In Theatres, 359 Boylston St., Boston, Mass.

ONAN Power Plants. 2500 watts. 120V. 60C.P.S., new, \$250. Kentucky Radio Kit Co., Box 35, C. T. Branch, Louisville 13, Ky.

AIRCRAFT-Marine Radio Electric Shop. Sale or lease. Come to beautiful St. Petersburg and step into a real live paying business. New equipment and inventory. Quarters available, low overhead. W. M. Wood, Pinellas Airport, St. Petersburg, Fla.

TOGGLE Switches, new H & H arrow 3 amp DPDT, ball handle, stem length 3/4", 4 for \$1.00, 9 for \$2.00. Rectifier capacitors, surplus Aerovox, 2000 mfd 35 VDC \$2.50 each. All items postpaid in U.S. Kissel Electric Products, 431-N, Sherman, Gallon, Ohio.

BARGAIN Hunting? Radio Servicemen write. Sensational catalog. Henshaw Radio Supply, 3619 Troost, Kansas City 3, Mo.

RADIO Diagrams under seven tubes 30c, over six tubes 60c. Television Diagrams \$1.00, with service data, \$2.00. State manufacturer and model number. Kramer's Radio Service, 36 Columbus Ave., New York 23, N. Y.

BARGAINS: New and reconditioned Hallicrafters, National, Collins, Hammarlund, RME, Meissner, other receivers, tuner, television receivers, transmitters, amplifiers, speakers, etc. Lowest wholesale prices. Terms. Shipped on trial. Liberal trade-in allowances. Write. Henry Radio, Butler, Mo., and 11240 W. Olympic, Los Angeles, Calif.

HEARING Aids. Zeniths, others. All used but working. Make miniature transmitters or receivers. Complete with cords, ear piece, \$20 ea. Shelby Instrument, 321 W. 7th, Long Beach, Calif.

RADIOS, record players, tubes, parts; send for free list. Mr. Morillo, Mike's Radio Service, 173 E. 101st St., New York 29, N. Y.

LOWEST Prices Radio Tubes, parts. Bargain lists, 3c. Potter, 1314 McGee, Kansas City 6, Mo.

WRITE Dept. RN18 for our free wholesale list of Radio parts & accessories. R. C. Radio Parts & Distributing Co., 731 Central Ave., Kansas City 6, Kan.

HOTTEST surplus list in the country. Electronics-Hydraulics, Aircraft-Gadgets. Dick Rose, Everett, Wash.

SPECIAL parts made to your spec. Very reasonable. Leo J. Vince, WSFYA, 2805 E. 117th St., Cleveland 20, Ohio.

WIRE Recorder, Webster 73, 6 spools wire and speaker, new. Best offer. Sweger, 118 McLain, Rockford, Ill.

ALUMINUM tubing, etc. Beams for Amateurs, TV, FM. Write for lists. Willard Radcliff, Fortoria, Ohio.

RADIO Parts 9c up! Tubes low as 29c. Speakers 89c up. Condensers 9c to 99c. Vibrators 99c. Loop Ants., 19c 500m Vol. Cont. v.s.w. 29c. No junk. No surplus. Free list. Paramount Co., 4406 York Blvd., Los Angeles 41, Calif.

CODE Tapes. Radiotelegraph tapes for Beginners, Advanced practice. Also designed for FCC preparation. Fits most phototube keyers. \$2.50 each, postpaid. For Tape list, write: Ultradyn Electronics, Oswego, Ore.

SURPLUS B-29 Gunsights, Servos, Computers, Motors, Automatic Pilots. Get list. Smead, 5608 Commercial, Everett, Wash.

WANTED

WE are eager to obtain privately owned electronic laboratory equipment. Write to The Overbrook Company, Overbrook, Mass.

MAGAZINES—Modern Electronics and Popular Electricity 1909. J. Landa, 157 Leverett, Boston 14, Mass.

URGENTLY need R. F. Plumbing parts, elevation and azimuth rotary joints, choke coupling, dipole antenna and wobbler assemblies which were used on SCR-615B. Electronic Engineering Co., 2008 W. 7th St., Los Angeles 5, Calif.

TEN SCR 694 new Government surplus Radio Receiver-Transmitters. Crescent International Corp., 16 Liberty St., New York 5, N. Y.

APR-4 Receivers and Tuning Units, any condition, any quantity, one or more; give condition and price in first letter. We also will buy anything of scientific interest, including quantities suitable for marketing; electronics surplus specialists. Engineering Associates, Farhills Branch Box 26, Dayton 9, Ohio.

TUNING units for GP-7 or TCE. Write to J. J. Towey, 1420 4th Ave. West, Seattle 99, Wash.

HELP WANTED

EXPERIENCED men to take charge of radio maintenance department for small scheduled airline. Write to Box 483, % Radio & Television News, 185 N. Wabash Ave., Chicago 1, Ill.

INSTRUCTORS in Electronics and Radio. Prefer former Navy Radio Technician instructors willing to locate in the Detroit, Mich., area. Write to Box 452, % Radio & Television News, 185 N. Wabash Ave., Chicago 1, Ill.

PATENT ATTORNEYS

LANCASTER, Allwine & Rommel. Registered Patent Attorneys. Patent practice before U.S. Patent office. Validity and Infringement investigations and opinions. Booklet and form "Evidence of Conception" forwarded upon request. Suite 414, 815 15th St., N.W. Washington 5, D.C.

HERMAN Lewis Gordon, Registered Patent Attorney. Patent Investigations and Opinions. Warner Building, Washington, D. C.

CORRESPONDENCE COURSE

AMATEUR radio licenses. Complete code and theory preparation for passing amateur radio examinations. Home study courses. American Radio Institute, 101 West 63rd St., New York 23, N. Y.

USED Correspondence courses and books bought, sold, rented and exchanged. Catalog free. Lee Mountain, Pisgah, Alabama.

RADIO & TELEVISION NEWS

USED Correspondence Courses and Educational Books, bought, sold, rented. Catalog free. Educational Exchange, Summerville, Ga.

MISCELLANEOUS

TRADE. American Flyer trains, test equipment, appliances, all new for boxed tubes. Army surplus in quantity, or? Send your list. C. L. Hollman, 122 N. Broadway Park, Lexington, Ky.

GET more distance. Subscribe "Radiobuilder," 3 issues 25c. Catalog. Laboratories, 378-C San Carlos, Calif.

EMBOSSED Business Cards 1,000, \$3.45 postpaid. Spada Enterprises, 10D Lexington, Wethersfield 9, Conn.

SWAP latest Bolex H-8 camera for Hallierafter SX-62 speaker and/or other equipment. Wm. Beska, 301 Fitch Rd., Hathoro, Pa.

ELEMENT One revision complete, Elements Five and Six newly released questions only with answers for Radio-telegraph exams; one dollar. A. A. McKenzie, 245 Poplar Ave., Fairmont, Hackensack, N. J.

F. M. CONVERTER, old to new band, with instructions. Paine, Cornelia St., Boonton, N. J.

TECHNICAL Report No. 101. Practical Transformer design, construction and repairing. \$2.00 Postpaid. Conrad Roeschke, Buckhorn, New Mexico.

27 YEARS of experience Radio Repairing. Simplified system. No calculations. No formulas. Total price \$2.00 postpaid or C.O.D. Moneyback guarantee. Ross Radio, 14615 Grandriver, Detroit 27, Mich.

INFINITELY variable voltage transformer operates from home lighting current. Steps voltage up or down. Vary speed of motors, dim lights, do radio test work. Copyright data \$1.00. PeJay Engineering, P.O. Box 1172, Oakland 4, Calif.

RADIOMEN, Servicemen, Beginners. Make more money, easily, quickly. \$250 weekly possible. We show you how. Information free. Merit Products, 216-32R 132 Ave., Springfield Gardens 13, N. Y.

FOR BARGAINS IN

Receivers, Transmitters, Amplifiers, Television Sets, Batteries, Instruction, Surplus Parts, Phonograph Records, and many more items.

Read

RADIO & TELEVISION NEWS
Classified Columns Every Month

NEW STANDARDIZING PROJECT

A PROJECT designed to establish standard service agreements and practices for television sets has been started by the Television Manufacturers Association.

The first step in the plan will be a survey of service organizations and dealers who service sets. TMA will seek recommendations from the various groups on the proposed standardization. Servicing and non-servicing dealers will also be contacted on their reaction to the proposal. Leading manufacturers and the public have also been invited to air their ideas on the subject.

As soon as this data has been sifted, TMA expects to be able to formulate a standardized service contract under which service organizations will be expected to meet certain qualifications as to experience, background, technical ability, and reputation.

The plan, according to Michael L. Kaplan, TMA president, will benefit the consumer, the service technician, and the manufacturer.

-30-

RADIO ENGINEERING I

COMPLETE Radio Engineering Course. Bachelor of Science Degree. Courses also in Civil, Electrical, Mechanical, Chemical, Aeronautical Engineering, Business Administration, Accounting, Secretarial, Science. Graduates successful. 66th year. Enter June, Sept., Jan., March. Write for catalog.

DEGREE IN 27 MONTHS

TRI-STATE COLLEGE
July, 1949

1679 College Ave.
Angola, Indiana

your MODERN MIRACLE TELEVISION line!

Revolutionary

**THREE MAGIC DIALS
TO PERFECT PERFORMANCE**

One easy turn of the dial and presto... picture and sound tune in simultaneously! No vertical, horizontal, brilliance or focus control! Remarkably brilliant and "flicker-free" pictures... amazingly sharp details... wonderfully clear reception. That is the miracle of Federal Television... so simple a child can operate it!

OTHER OUTSTANDING FEATURES

- DISTINCTIVE STYLING!
- TELEVISION SCREENS 12½ INCHES AND UP!
- POWERFUL NEW CIRCUITS!
- AUTOMATIC GAIN CONTROL!
- FULL CHANNEL COVERAGE!
- AUTOMATIC PICTURE LOCK!

HERE'S YOUR 1950 LINE NOW!
SLATED TO BE YOUR BIGGEST SELLER TODAY!
CHOICE TERRITORIES AVAILABLE!
WRITE, WIRE, OR PHONE DEPT. 6G FOR DETAILS!



137 DUANE ST. • NEW YORK 13 • FACTORIES: NEW YORK • CONN.

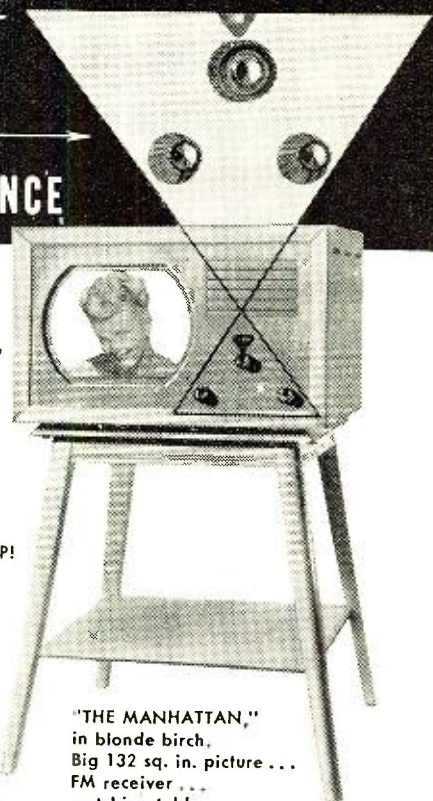

"THE MANHATTAN,"
in blonde birch.
Big 132 sq. in. picture...
FM receiver...
matching table.

SAVE MONEY BRAND NEW GUARANTEED GENERAL ELECTRIC SELSYN

Type 2JIG1
Will operate from 110 volts, 60 cycle by using a resistor or a condenser in series. Size is 2¼" in diameter x 4¾" long. Ideal for beam antenna position indicator.



Price **\$2.75**
per pair — removed from new equipment

HAYDEN TIMING Type 45629R
110 volts, 60 cycle, 2.2 watts, 1/240 R.P.M.



Price **\$3.00**
ea. net, new.

HAYDEN TIMING Type 36938-2
110 volts, 60 cycle, 2.2 watts, ½ R.P.M.

Price **\$3.00**
ea. net, new.



DELCO ALNICO Field Motor Type 5069466
27.5 volts D.C. 10,000 R.P.M. 1" x 1¾" x 2¼" long.

Price **\$3.00**
ea. net—new.

INSTRUMENT ASSOCIATES
147-57 41st Ave., Flushing, N. Y.
Independence 3-1919

CREI Prepares Young Men for Professional Careers with Industry-Recognized training in a minimum of time
RADIO-ELECTRONICS-TELEVISION ENGINEERING

GRADUATES of the Capitol Radio Engineering Institute residence school are preferred by industry because of their training and ability. This recognition is the reason that CREI men quickly find good jobs in radio-electronics-television engineering and technical fields.

With 22 years of practical teaching experience in these highly technical fields, CREI offers an outstanding faculty, modern and complete laboratories, shops and equipment.

New students are accepted twice monthly and each may advance as rapidly as he is capable. The basic course with one specialized course requires an average of 20 months to complete, depending on the ability of the individual student.

CREI is recognized as one of the country's leading technical institutes. Its work is of college level. It prepares the young man for a good job in industry in a minimum of time.



Approved for Veterans' Training

CAPITOL RADIO ENGINEERING INSTITUTE
An Accredited Technical Institute Founded in 1927

MAIL COUPON FOR FREE CATALOG
Capitol Radio Engineering Institute, Dept. 137-A
16th and Park Rd., N.W., Washington 10, D.C.

Please send me your catalog and details.

Name _____ Age _____
Street _____
City _____ Zone _____ State _____

I am entitled to training under G.I. Bill.

FACTORY TO YOU DIRECT!

THE NEW
Certified
TELEVISION KIT

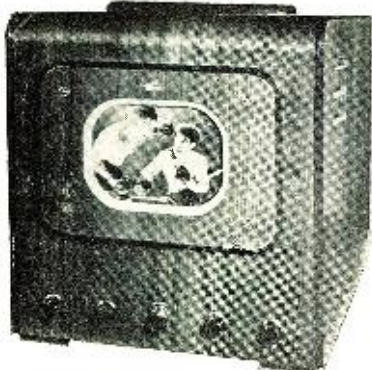

10" KIT \$64.50*
*LESS TUBES

7" KIT \$54.50 **\$89.50**
Less tubes with all tubes

Money Back Guarantee—Buy it, inspect it, if you don't think it's the best buy on the market—return unused within five days and your money will be refunded.

All prices F.O.B. New York. 20% deposit with order

IMMEDIATE DELIVERY

Certified TELEVISION LABORATORIES
5507 — 13th AVE. BKLYN. 19, N. Y.

WANTED

TELEPHONE CARRIER EQUIPMENT
(Western Electric) types C, CF-1, CF-3,
CF-4, CF-5, H, H-1.

TELEGRAPH CARRIER EQUIPMENT
(Western Electric) X-61822A, CF-2,
CF-6, 40ACL

TELETYPEWRITERS—All Models.

TELEPHONE SWITCHBOARDS—
Manual and automatic.

RADIO TELEPHONE LINKS—
AN/TRC-1, AN/TRC-3, AN/TRC-4,
T-14/TRC-1 Transmitters, R-19/TRC-1
Receivers, Antennas.

Box 484, % RADIO & TELEVISION NEWS
185 N. Wabash Ave. Chicago 1, Ill.

QUAD SMASHES PRICES!

Write for Midsummer Sale
Circular—Red Hot Bargains
AD ELECTRICAL SUPPLY, INC.
1650 N. Damen, Chicago 47, Ill.

INDEX OF Advertisers

JULY
1949

While every precaution is taken to insure accuracy, we cannot guarantee against the possibility of an occasional change or omission in the preparation of this index.

ADVERTISER	PAGE	ADVERTISER	PAGE
Acorn Electronics Corp.	137	Lehigh Television Company	89
Aero Towers	121	Leotone Radio Co.	80
Airborne Sales Co., Inc.	130	Lifschultz Fast Freight	133
Alliance Manufacturing Company	68		
Allied Radio Corp.	9	Mallory & Co., Inc., P. R.	4th Cover
Altec Lansing Corporation	80	Martin School of Radio Arts, Don.	113
American Phenolic Corporation	97	Mass. Radio School	130
American Radio Institute	133	Aerit Coil & Transformer Corp.	14
American Television & Radio Co.	82	Mid-America Co., Inc.	104
Amplifier Corp. of America	101	Midway Sales Co.	111
Arrow Sales, Inc.	129	Milwaukee School of Engineering	109
Ashe Radio Co., Walter.	76, 77, 124	Mohawk Electronics Co.	129
Audio Development Co.	91	Mosley Electronic Specialties	116
		McGee Radio Company	69, 70, 71
Baltimore Technical Institute	129	McGraw-Hill Book Co.	132
Bell Telephone Laboratories	18		
Bliss Electrical School	103	Nation Wide Radio	81
Brook Electronics, Inc.	123	National Company, Inc.	19
		National Radio Institute	3
C. & H. Sales Co.	134	National Schools	17
Candler System	125	Nescorp Electronics, Division of National Equipment & Supply Co., Inc.	74
Cannon Electric Development Company	60	Nettles Manufacturing Co.	128
Capitol Radio Engineering Institute	23, 135	Newark Surplus Materials Co.	125
Centralab, Division of Globe-Union, Inc.	24, 25	Newcomb Audio Products Co.	116
Certified Television Laboratories	125, 136	Niagara Radio Supply Corp.	130
Chicago Industrial Instrument Co.	85, 131		
Chicago Transformer, Division of Essex Wire Corporation	67	Offenbach & Reimus Co.	99
Cinacundagraph Speakers, Division of Aireon Mfg. Corp.	74	Olin Industries, Inc.	21
Cinex, Inc.	111	Onan & Sons, Inc., D. W.	88
Clear-Vac Co.	119	Opad-Green Company	87
Cleveland Institute of Radio Electronics	5		
Clippard Instrument Laboratory, Inc.	68	Peak Electronics Co.	112
Columbia Electronics	86	Peerless Transformer, Div. of Altec- Lansing	74
Comet Electronic Sales Co.	107	Photocon Sales	91
Commercial Radio Institute	117	Premax Products	134
Communications Equipment Company	83	Premier Radio Tube Company	73
Communications Measurements	123	Progressive Electronics Co.	108
Cosmic Counters	121	Pyramid Electric Company	20
Coyne Electrical & Radio School	126		
		Quad Electrical Supply Inc.	136
DeForest's Training, Inc.	7	Quam-Nichols Co.	97
Dynamic Television of Washington, D.C.	130		
		RCA Institutes, Inc.	107
Editors and Engineers	72	R & M Radio Company	119
Edlie Electronics Inc.	80	R & T Electronics Company, Inc.	105
Electro-Technical Industries	95	Radio Corporation of America	6
Electronic Instrument Co., Inc.	81	Radio Craftsmen Inc., The	78
Electronic Measurements Corp.	106	Radio Electric Co.	130
Electronic Supplies	94	Radio Ham Shack Inc.	79
Electronics Institute, Inc.	121	Radio Kits Company	90
Ers. ROYAL	113	Radio Parts Company	101
Esege Sales Co. Ltd.	130	Radio Research Products	136
Espey Manufacturing Company, Inc.	105	Radio Supply & Engineering Co., Inc.	114
		Radionic Equipment Company	106
Fair Radio Sales	88	Rauland-Borg Corp.	97
Farwest Trading Co., Inc.	127		
Federal Telephone and Radio Corporation	26, 106	Sams & Co., Inc., Howard W.	10
Federal Television Corp.	135	Senco Radio, Inc.	103
Feiler Engineering Co.	132	Sonotone	118
Franklin-Ellis Co.	121	Sovereign Television Co.	125
		Spellman Television Co., Inc.	127
G. L. Electronics	122	Sprague Products Co., Inc.	123
General Electric Company	2nd Cover, 59	Stahl, Inc., Michael	100
General Electronic Distributing Co.	75	Standard Radio & Electronic Products	116
General Test Equipment	103	Standard Transformer Corporation	16
Goodheart, R. E.	107	Sternoff's Ham Shack	109
Gould Green	103	Sun Radio and Electronics Co., Inc.	127
Greylock Electronics Supply Co.	125	Sun Radio of Washington, D. C.	110
		Supreme Publications	85
Harvey Radio Company Inc.	98	Sutton's Wholesale Electronics, Bill	105
Heath Company, The	61, 62, 63, 64, 65	Sylvania Electric	15
Henry Radio Stores	131		
Hiway Company	68	TAB	93
Hollywood Sound Institute, Inc.	107	Tech-Master Products Co.	128, 130
Hytron Radio and Electronics Corp.	11	Technical Radio Parts Co.	129
		Telex, Inc.	22
Indiana Technical College	111	Transvision, Inc.	12
Instructograph Company	117	Tri-State College	135
Instrument Associates	135		
International Resistance Co.	115	Valparaiso Technical Institute	115
JFD Manufacturing Co., Inc.	120	Ward Leonard Electric Co.	111
Jensen Manufacturing Company	13	Ward Products Corporation	3rd Cover
Jerrold Electronics Corp.	92	Weller Manufacturing Company	8
		Wells Sales, Inc.	138
Kemode Mfg. Co.	133	Wholesale Radio Parts Co., Inc.	102
		Workshop Associates Inc., The	137
LaPointe-Plascomold Corp.	133	World Radio Laboratories Incorporated	113
Lear, Incorporated	16		
Leco Engineering Co.	115		
Leeds Radio Co.	117		

THAT'S A LONG WAY AWAY!

JOHN B. SPENCER of Spencer's Radio Service, Savanna, Illinois, has written us about a new long-distance record for television reception.

On April 27th, John received perfect video and excellent sound reception from station WTVJ in Miami, Florida, a distance of approximately 1500 miles. He reports that between 7:10 and 8:49 p.m. (C.S.T.) reception was sufficiently good to permit the booster to be disconnected. An Admiral television receiver and an Amphenol stacked array 85 feet above ground were used in this instance. Mr. Spencer notes, however, that since his organization has been doing considerable research on the problems of fringe area reception, the installation had been made with the greatest care.

One of Mr. Spencer's most cherished mementoes is a letter from Earl W. Lewis, chief engineer of station WTVJ in Miami, in which Mr. Lewis states: "This is confirmation of your reception of our television programs on the evening of April 27th, 1949. Your letter and one from Indianapolis are the greatest distance we have heard from thus far. Thanks very much for your interesting letter and appreciate the interest shown in the reception of our station."

-30-

ERRATA

In the April edition, our International Short-wave Dept. reports, in error, that Canada has no facilities at present for utilizing the 21 mc. band. As stated by E. J. Clark, of the CBC International Service, Canada has 21 mc. antennas for transmission on this band to Africa as well as to South America and the West Indies. These antennas like all the antennas used at Sackville are curtain arrays. The 21 mc. antennas are the 4/4 type, i.e., four horizontal half-wave elements fed in-phase with four such stacks in the vertical plane giving a gain of approximately 20 db.

On page 45 of the April issue, Table 2, Fig. B and C were arranged incorrectly. They should be interchanged.

On page 110 of the May issue, the Ninth District Office should have been listed as being in Houston, Texas, and not Galveston. The new address is: Federal Communications Commission, Engineer-in-charge, District Nine, U. S. Appraiser, Store Bldg., 7300 Wingate St., Houston, Texas.

PHOTO CREDITS

Page	Credit
27, 29	DeMornay Budd, Inc.
28 (Figs. 2-3) 132 (top)	National Bureau of Standards
28 (Fig. 4) 132 (bottom)	Atomic Energy Commission
30, 31 (lower left)	Columbia Broadcasting System
31 (top)	WGN-TV
31 (lower right)	WENR-TV
37	American Television, Inc.
38	The Better Home Shop
46 (top)	Cleervue Television Corp.
46 (center)	Motorola, Inc.
46 (bottom) 48	Radio Corporation of America
47 (top and bottom)	General Electric Co.
47 (center)	Allen B. DuMont Laboratories, Inc.
49 (top, left)	Zenith Radio Corp.
49 (top, right)	Hoffman Radio Corp.
49 (bottom, left)	Admiral Corporation
49 (bottom, right)	Garod Electronics Corp.
56, 57, 58	The Ward Products Corp., Div. of Gabriel
90	U. S. Coast Guard
95	U. S. Army
102	U. S. Army Air Force

HEADQUARTERS FOR TOP VALUES

ACORN

• SPEEDY SERVICE
• GREATER BUYS

TV COMPONENTS

RCA front end, completely aligned, 3 tubes, for 630 chassis	\$36.95
RCA Type 1F and Video Coil Kit	10.95
Horizontal Output and H.V. Transformer	6.95
Voltage Control Kit, RCA Type, Complete—9 controls	9.85
Vertical Output Transformer	2.99
Punched Chassis for 630 RCA Type	5.25
Deflection Yoke, RCA Type	4.95
Focus Coil	4.55

★ DEFLECTION YOKE

RCA Type 201 D2 used for 5TP4 projection tubes, Very Special	\$ 4.69
SLEEPER SPECIAL—5TP4's CR Tube, scored but electronically perfect. Excellent for experimenting. Complete with yoke	10.95
300 Ohm Twin Lead Transmission Line—100 ft. length	1.79

FULL LINE OF RCA 630 TV KITS—SAVE MONEY! WRITE FOR PRICES AND FLYER

FM COMPONENTS

3 gang variable condenser with drum	\$1.10; 3 for 3.00
4 gang—3-30 maud.	1.79; 3 for 4.75
★ IF TRANSFORMER	
10.7 mc. (shielded)	.59c each; 3 for \$1.59
Discriminator transformer to match	.69c each; 3 for 1.89

STANDARD COMPONENTS

★ BARGAINS IN SPEAKERS

8" Magnavox PM 22 oz. Alnico III Magnet 8 watts output. A Terrific Value	\$ 2.99
10" PM Jensen, "Standard Series" P10T ST. 119. An excellent speaker for good quality radio sets or PA systems. Output undistorted 8 watts. Voice coil impedance 6-8 ohms. Wt. 7 lbs.	\$ 4.49
12" high fidelity extended range 50-10,000 Cy. Jensen PM 12SH. Alnico V Magnet, 6-8 ohms voice coil imp. 9 watts output. Wt. 12 lbs. (List \$18)	\$ 8.45
12" coaxial JRP-40 Jensen high fidelity, tweeter woofer. Built-in network. Frequency range 50-12,000 C.P.S. Voice coil impedance 6-8 ohms. 12 watt undistorted output. Wt. 15 lbs.	\$16.50

★ TRANSFORMERS

Stancor, 800 v. ct. @ 200 mils. 6.3 @ 7 amps. 3v @ 6 amps. Very Special	\$3.99
Stancor Output Transformer, 61.6 p.p. parallel, 30 watts output. Voice coil tapped @ 4-8-15-500 ohms impedance. Upright mount.	2.69
Stancor—61.6 p.p. Output Transformer, 25 watt output. Voice coil tapped @ 4-8-15-250-500 ohms impedance. Upright mount.	2.59
Stancor Inter stage Transformer, p.p. plate to p.p. grids. Upright mount.	1.39
Thordarson, Pri. 115v 60 cy. Sec. 750v ct. @ 143 mils. 6.3v @ 4.5 amps. 5v @ 3 amps. upright mt. Wt. 7 lbs. Each Only	3.29
Thordarson, Pri. 115v 60 cy. Sec. 600v ct. @ 100 mils. 6.3v @ 3 amps. 3v @ 2 amps. 1/2 shell mgr. Mtg. centers 2 3/16" x 2 3/8". Dimensions: H-3 1/4" W-3 3/8" D-2 3/16". Wt. 5 lbs. A Real Bargain.	2.69
Power Transformer, 500v ct. @ 55 mils. 6.3v @ 1 amp. 5v @ 2 amps. Upr. mt.	1.49
Isolation Transformer: 115v 60 cy input. Sec. 125v 60 mils. 135v 60 mils. 6.3v @ 1.2 amps. Upr. mt.	1.47

★ FILTER CHOKES

	Hy	Mils	Ohms DC	Each
Thord. Channel Mt.	10	55	350	\$.69
Stancor Herm. Sealed	15	70	420	.79
Thord. Channel Mt.	19	85	250	.89
Stancor Upr. Mt.	10	150	70	1.49
Channel Mt.	2 1/2	235	60	1.59
G.E. Herm. Sealed	10	250	100	2.49
Stancor Upr. Mt.	10	300	55	2.79
Cased	5	400	300	3.25

PHONE: WORTH 4-3270

ACORN ELECTRONICS CORP.

76 Vesey St., Dept. N-7, New York 3, N. Y.

TERMS: 20% cash with order. Balance C.O.D. All prices F.O.B. our warehouse in New York City. No orders under \$2.50.

TELEVISION RECEPTION PROBLEM—No. 5 of a series
WIND—RAIN—SNOW—ICE
Weather is a major factor in TV antenna performance. Along with acknowledged electrical superiority, Workshop antennas have proven equal to Florida hurricanes and Alaskan ice storms. For a rugged, clean-cut, permanent antenna installation, why not get the best? Specify Workshop.

Send for the new Workshop TV Catalog (No. 49)

THE **WORKSHOP ASSOCIATES, Inc.**

Specialists in High-Frequency Antennas

62 NEEDHAM STREET, NEWTON HIGHLANDS 61, MASSACHUSETTS



RELAYS

FOR EVERY PURPOSE

Over a Million in Stock!

Whether you require large quantities of relays for production runs or single units for laboratory or amateur work, Wells can make immediate delivery and save you a substantial part of the cost.

Our capable engineering staff is prepared to offer assistance in the selection of correct types to suit your exact requirements.

Each relay is brand new, standard make, inspected, individually boxed and fully guaranteed.

The following list represents only a tiny portion of our relay stock. Write or wire us for information on types not shown.

STANDARD DC TELEPHONE RELAYS

Stock No.	Operating Voltage	Coil Resistance	Contacts	Manufacturer	Net Each
R-101	24V	1500.	SPDT (NO)	Auto. Elec.	\$1.35
R-102	24V	400.	SPDT	Auto. Elec.	1.10
R-103	24V	DUAL-1000	3PST (NO)	Auto. Elec.	1.35
R-105	24V	600.	3PST (NO)	Clare	1.20
R-106	24V	1300.	3PST (NC)	Clare	1.25
R-152	12V	50.	DPDT-SPST (NO)	Guardian	1.10
R-153	12V	200.	SPDT-SPST (NO)	Stromberg	1.20
R-154	12V	200.	SPST (NO)	Clare	1.20
R-155	12V	100.	SPST (NO/4NC)	Auto. Elec.	1.15
R-158	6V	50	4PST (NO)	Stromberg	1.10
R-159	6V	50	4PST (NO)	Stromberg	1.10
R-160	6V	12	3PDT-3PST (NO)	Auto. Elec.	1.05
R-161	6V	10	3PST (2NC-1NO)	Auto. Elec.	.90
R-121	150V	5000.	2PST (NO) SPDT	Clare	1.65
R-123	150V	6300	SPST (NO)	Clare	1.75
R-602	150V	6500	SPST (NO)	Clare	1.75
R-515	24V	750	SPST (NO)	Clare	1.25
R-517	12V	250	DPST (NO)	Clare	1.20
R-519	250V	14000.	SPDT	Auto. Elec.	1.95
R-520	250V	14000	DPDT	R.B.M.	2.10
R-521	32V	1000.	DPDT	Kellogg	1.20
R-166	24V	DUAL-200.	DPDT-SPST (NO)	Stromberg	1.59
R-168	24V	DUAL-200.	4PST (NO)	Auto. Elec.	1.20
H-240	250 350V	40000	DPST (NO)	Auto. Elec.	2.95
H-241	48V	650	SPDT-SPST (NO)	Clare	1.25

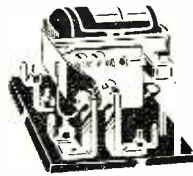

SENSITIVE DC RELAYS

Stock No.	Operating Voltage	Coil Resistance	Contacts	Manufacturer	Net Each
R-218	4-6V	1800.	SPDT	Kurman 220C	\$1.95
R-220	75V	5000	SPDT	Allied Cont.	1.20
R-221	18-24V	5000	SPST (NO)	Allied Cont.	1.15
R-174	250V	5000	DPST (NO)	G.M.	2.95
R-175	350V	11000	DPST (NO)	G.M.	1.50
R-176	24V	250	DPDT-SPST (NO)	G.M.	1.65
R-177	24V	300	4PDT	G.M.	2.10
R-600	8-12V	5000	SPDT	S. Gunn-KS	1.15
R-507	24-48V	1000	SPDT-DPST (NC)	Guardian	1.15

CUTLER HAMMER HEAVY DUTY CONTACTORS



Stock No.	Operating Voltage	Coil Resistance	Contacts	Manufacturer	Net Each
R-178	24V DC	100	SPST (NO) 100A.	614H34A	\$3.85
R-179	6V DC	6.5	SPST (NO) 50A.	6C41H83A	3.00
R-180	12V DC	25.	SPST (NO) 50A.	604H308	3.25
R-181	24V DC	65	SPST (NO) 100A	604H48B	3.85
H-232	24V	55.	SPST (NO) 50A.	Metal Case	3.25
H-233	6V	15.	SPST (NO) 50A.	Metal Case	3.15
H-235	24V	70.	SPST (NO) 100A.	Type B6	3.85

DIRECT CURRENT AIRCRAFT CONTACTORS

Stock No.	Operating Voltage	Coil Resistance	Contacts	Manufacturer	Net Each
R-182	28V	80	SPST (NO) 25 A.	Guardian	\$1.85
R-183	24V	60	SPST (NO) 50 A.	Allen Bradley	2.75
R-184	28V	50	SPST (NO) 100A.	Type B6A	2.95
R-185	24V	100	SPST (NO) 50 A.	General Elec.	2.45
R-186	24V	132	SPST (NO) 50 A.	Leach 7220-3-243.50	2.75
R-187	24V	100	SPST (NO) 50 A.	Allen Bradley	2.95
R-188	24V	200	SPST (NO) 75 A.	Allied Cont.	2.95
H-234	14V	45	SPST (NO) 30 A.	—	1.65

ANTENNA CHANGEOVER RELAYS

Stock No.	Operating Voltage	Coil Resistance	Contacts	Manufacturer	Net Each
R-192	6-12V DC	44	2PDT 10 AMP	Allied-NBS	\$1.35
R-231	12V DC	100.	DPDT 6 AMP	G. E.	1.95
R-256	24-32V DC	—	DPDT-SPST (NC) 1KW	Guardian	1.45
R-501	110 AC	4.	OPDT (1KW)	G. E.	2.45
R-503	12-32V DC	100.	SPDT-5PST	G. E.—500 W.	1.95

COMBINATION PUSH BUTTON AND REMOTE RELAY

Stock No.	Operating Voltage	Coil Resistance	Contacts	Manufacturer	Net Each
H-244	12-24 V DC	Dual-60	SPDT	CR2791-R106C8	\$1.65

ADJUSTABLE TIME DELAY RELAY

Stock No.	Operating Voltage	Coil Resistance	Contacts	Manufacturer	Net Each
R-246	115 AC	—	SPST (NO) or (NC) 10 AMP	R. W. Cramer 1-120 Sec.	\$8.95

DC MECHANICAL ACTION RELAYS

Stock No.	Operating Voltage	Coil Resistance	Contacts	Manufacturer	Net Each
R-245	12V	25.	4* Lever	G.M.	\$0.95
R-527	6-12V	200.	2* Lever	—	.95

TYPE C.M.S. RELAY

Stock No.	Operating Voltage	Coil Resistance	Contacts	Manufacturer	Net Each
R-511	24V DC	200	MICRO-SW. SPST (NO)	Clare	\$2.45

DC CURRENT REGULATOR

Stock No.	Operating Voltage	Coil Resistance	Contacts	Manufacturer	Net Each
R-509	6-12V DC	40	SPST (NC)	G. E.	\$0.85

LATCH AND RESET RELAY

Stock No.	Operating Voltage	Coil Resistance	Contacts	Manufacturer	Net Each
R-500	12V DC	10.	DPDT-10 AMP	St. Dunn CX-3130B	\$2.85

DC-ROTARY STEP RELAY

Stock No.	Operating Voltage	Coil Resistance	Contacts	Manufacturer	Net Each
R-621	6-12V	30.	3 POLE 23 POSITION	W. E.	\$10.95

DC-RACHET RELAY

Stock No.	Operating Voltage	Coil Resistance	Contacts	Manufacturer	Net Each
R-230	5-8V	2.	SPDT-DPST (NO)	Guardian	\$2.15

Special Sample Engineering Offer
Any ten relays listed (one of each type) with the exception of Stock Nos. R-621 and R-246—only \$10.00.

ORDER DIRECTLY FROM THIS AD OR THROUGH YOUR LOCAL PARTS JOBBER
Manufacturers: Write For Quantity Prices.
Distributors: Write For The New Wells Jobber Manual.

TYPE 18 DC TELEPHONE RELAYS

Stock No.	Operating Voltage	Coil Resistance	Contacts	Manufacturer	Net Each
R-109	24-48V	4000.	SPDT	Auto. Elec.	\$1.50
R-110	24-32V	300	SPST (NO)	Auto. Elec.	1.75
R-112	90-120V	6500	SPST (NC)	Auto. Elec.	1.30
R-114	24V	500	4PST (NO)	Auto. Elec.	1.25
R-603	24V	400	DPST (NO)	Auto. Elec.	1.25
R-233	24V	150	DPDT-SPST (NC)	R.B.M.	1.25
H-239	24V	180	DPST (NO)	Auto. Elec.	1.25



SEALED DC TELEPHONE RELAYS

Stock No.	Operating Voltage	Coil Resistance	Contacts	Manufacturer	Net Each
R-125	24V	2000	DPDT	Clare	\$2.75
R-126	90-120V	2000	DPDT	Clare	3.00
R-504	24-70V	2800	SPDT	GE-C103C25	3.00

V TYPE DC TELEPHONE RELAYS

Stock No.	Operating Voltage	Coil Resistance	Contacts	Manufacturer	Net Each
R-164	24-32V	1000.	SPST (NO)	W. E.	\$1.20
R-512	24-48V	3500	DPDT	W. E.	1.30
R-513	12-24V	300	DPDT-SPST (NC)	W. E.	1.20
R-514	4-6V	60	SPDT	W. E.	1.05
R-526	6V	35	DPDT-SPST (INC-1NO)	W. E.	1.05

AC-STANDARD TELEPHONE RELAYS

Stock No.	Operating Voltage	Coil Resistance	Contacts	Manufacturer	Net Each
R-212	90-135V	—	NONE	Clare	\$0.95
R-213	5-8V	—	DPST (NO)	Clare	1.50
R-605	24V	—	3PST (NO)	Auto. Elec.	.95
R-606	24V	—	DPST (NO-1NC)	Auto. Elec.	.95
R-607	24V	—	SPST (NO)	Auto. Elec.	.95



DIRECT CURRENT MIDGET RELAYS

Stock No.	Operating Voltage	Coil Resistance	Contacts	Manufacturer	Net Each
R-132	24V	300	DPDT	Clare	\$1.20
R-133	24V	300	NONE	Clare	1.50
R-134	24V	250	4PDT	Clare	1.20
R-135	24V	300	SPST (NC)	Clare	1.15
R-137	24V	300	SPDT	Clare	1.15
R-138	24V	300	4PST (NO)	Clare	1.15
R-139	24V	200	4PDT	Clare	1.15
R-140	24V	200	SPDT	R.B.M.	1.15
R-141	24V	280	3PST (NO)	R.B.M.	1.15
R-142	24V	400	DPDT	Allied Cont.	1.20
R-143	24V	280	SPST (NO)	R.B.M.	1.15
R-144	24V	250	SPST (NO)	Allied Cont.	1.15
R-145	24V	300	DPST (NO)	Allied Cont.	1.15
R-146	12V	126	DPST (1NO) (1NC)	Clare	1.10
R-147	9-14V	75	SPDT	Guardian	1.05
R-148	12V	100	DPDT-SPST (NC)	Price Bros.	1.10
R-149	6-8V	45	SPST (NC)	Clare	1.00
R-150	6V	30	SPST (NO)	E-Z Elec.	.95
R-522	2-6V	2.	SPST (NO)	R.B.M.	.65
R-523	90-125V	6500	DPDT	Clare	1.90
R-222	12V	100	DPST (NO)	P & B	.95
H-242	24-32V	300	DPDT	R.B.M.	1.20
H-243	24-32V	300	4PDT	R.B.M.	1.20

TYPE B0 DC RELAYS

Stock No.	Operating Voltage	Coil Resistance	Contacts	Manufacturer	Net Each
R-169	24V	250	SPST (NO)	Allied Cont.	\$1.95
R-171	24V	230	DPDT	Allied Cont.	2.15
R-172	5-8V	30	DPDT-SPST (NO)	Allied Cont.	1.70
R-173	2-6V	5	SPST (NO)	Allied Cont.	1.25
R-529	24-48V	1000	DPDT	Allied Cont.	2.50

TYPE BJ DC RELAYS

Stock No.	Operating Voltage	Coil Resistance	Contacts	Manufacturer	Net Each
R-204	12V	65	SPST (NO)	Allied Cont.	\$1.15
R-205	24V	260	DPDT	Allied Cont.	1.25
R-224	12V	75	SPST (NO)	Allied Cont.	1.15
H-237	27V	230	DPDT	Allied Cont.	1.25

HEAVY DUTY KEYING RELAYS

Stock No.	Operating Voltage	Coil Resistance	Contacts	Manufacturer	Net Each
R-248	28V DC	150	SPST (NO) 10A.	Guard. 36471	\$1.05
R-244	75V AC	265	SPST (NO) 20A.	Leach 1327	1.75
R-206	24V DC	150	SPDT-3 AMP.	P&B-KL	1.20
R-207	24V DC	210	4PDT-3 AMP.	P&B-KL	1.10
R-219	50V DC	1500	DPST (NO) 15A.	P&B-SP	1.25
R-217	115 AC	600	DPDT-10 AMP.	St. Dunn 1KAX2.25	1.25
R-525	24V DC	200	DPDT-10 AMP.	Guard. 34464	1.25
R-508	110 AC	600	SPDT-6 AMP.	Guard. 37189	1.95
R-506	24 V DC	300	DPST (NO) 6A.	Guard. 516903	1.05
R-510	24 V DC	200	3PDT-10 AMP.	St. Dunn-B2A	1.25
R-604	24 V DC	200	SPST (NO) 30A.	St. Dunn-1HX2.25	1.25
H-608	115 AC	—	SPST (NO) 20A.	Guard-BK2	1.05
R-620	12V DC	35	3PST (NO) 10A.	Price Bros.	1.35
R-223	28V DC	150	SPST (NO) 40A	Price Bros.	1.20
H-230	12-24V DC	80.	DPST (NO) 10A.	R.B.M.	1.15
H-231	24V	230.	DPST (NO) 5A.	—	—

DC-TYPE 76 ROTARY RELAYS

Stock No.	Operating Voltage	Coil Resistance	Contacts	Manufacturer	Net Each
R-197	9-16V	70	DPDT	Price Bros.	\$1.65
R-198	9-16V	125	6PST (3NO)	Price Bros.	1.65
R-199	24-32V	250	(3NC) SPDT	Price Bros.	1.65
R-200	24-32V	275	SPDT-10 AMP	Price Bros.	1.65
R-201	24-32V	250	DPST (NO) SPDT	Price Bros.	1.65
R-601	9-14V	60.	(NC) DPDT 3PST (NO)	Price Bros.	1.65

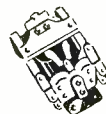

DIRECT CURRENT KEYING RELAYS

Stock No.	Operating Voltage	Coil Resistance	Contacts	Manufacturer	Net Each
R-190	12V	65	DPDT 10 AMP	Advance Elec.	\$1.15

WARD SMASHES TV ANTENNA INSTALLATION COSTS!

IT COSTS ONLY 6c IN LABOR TO ASSEMBLE WARD'S SENSATIONAL MINUTE MAN ANTENNA

(WP) CLEVELAND, OHIO

The Chief Engineer of the Ward Products Corporation states that the new sensational Minute Man antennas are being made of PERMA-TUBE — a newly perfected non-corroding coated steel tubing, created especially for Ward by the Jones and Laughlin Steel Corp., Pittsburgh, Pa. Independent laboratory tests on over 30 metals commonly used for antennas have proved PERMA-TUBE the best for all weather installations. Aluminum is too weak and other types of coated steel corrodes. Ward is the only manufacturer using PERMA-TUBE in constructing antennas. See your Ward Distributor today.

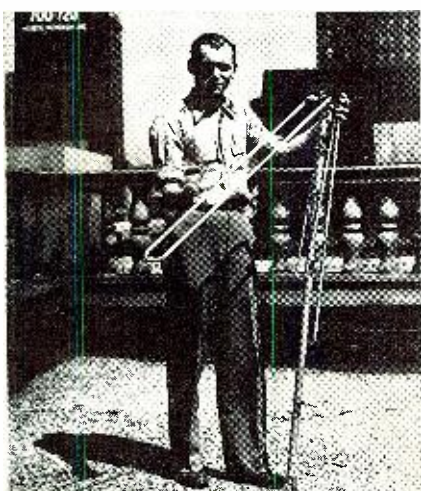

Dick Moss, television engineer, flicks up dipole in assembly operation of Ward Minute Man antennas. (Model TV-46).



A few seconds later and Dick snaps the high frequency dipole into position. It costs only 6c in labor to assemble this Ward Minute Man antenna.

FLASH!

WARD USES PERMA-TUBE IN CONSTRUCTING MINUTE MAN ANTENNAS.

(WP) CLEVELAND, OHIO

The Ward Products Corporation, a Division of the Gabriel Company, disclosed today their new Minute Man line of TV antennas. These 13 antennas, ranging in list prices from \$2.45 to \$49.95 are completely pre-assembled. Where it formerly took two installation men three-quarters of an hour (or approximately \$7.50 in labor) to assemble the ordinary TV antenna, one man can assemble any Ward Minute Man antenna in a few minutes. This is the greatest technical engineering improvement in the antenna field and the Ward engineers are to be congratulated on its achievement. They have spent many months in their laboratory perfecting the many ingenious construction features. See your Ward distributor today.

GREATER INCOMES AND PROFITS REALIZED BY INSTALLING WARD ANTENNAS.

(WP) NEW YORK, N. Y.

Now you can make big money on a standard installation fee. It has been reported that servicemen and retailers are realizing greater profits by installing Ward Minute Man Antennas. The quick 3 minute installation makes the big difference. It means more installations per day and at greater returns. No consumer complaints have been registered by big labor bills. See your Ward distributor today.

See Your
Ward Distributor
Today

INTRODUCING WARD'S NEW "MINUTE MAN" TV ANTENNAS

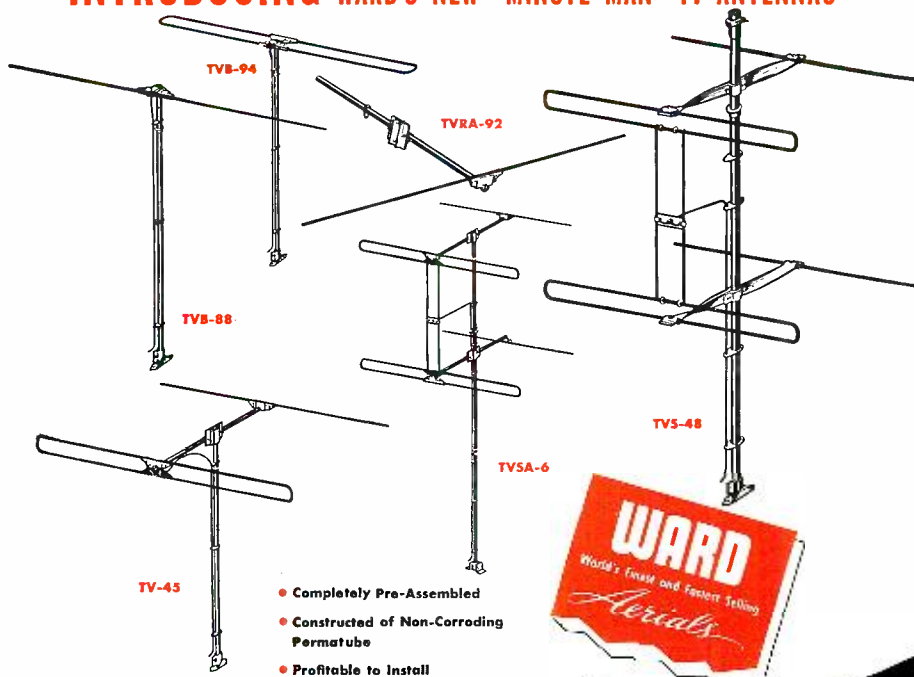

- Completely Pre-Assembled
- Constructed of Non-Corroding Permatube
- Profitable to Install

There are Ward Minute Man Antennas for every purpose and use from any distance from the transmitter. See your distributor today.

Dependable Starting is One Reason Why MALLORY VIBRATORS Are So Popular!

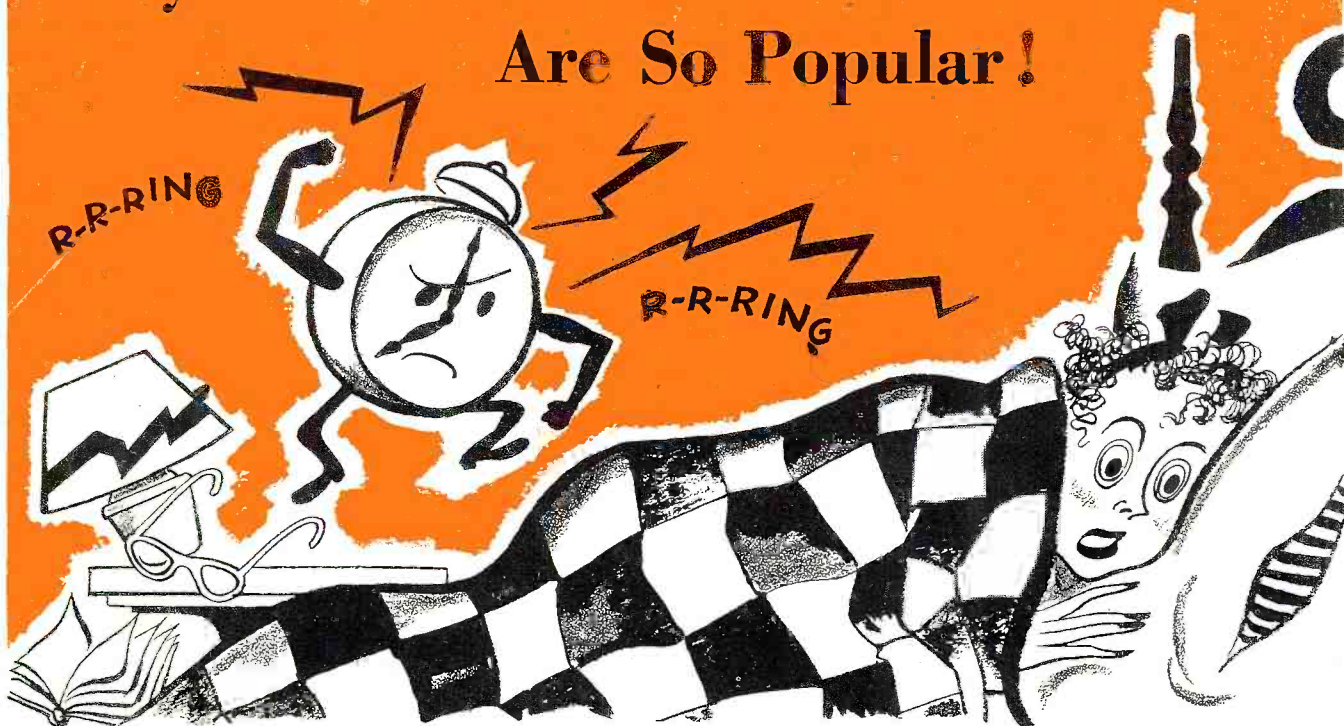

And there is more than one reason why Mallory Vibrators are so dependable in starting and why knowing radio service men choose them *every time*. Read the facts and see for yourself.

The contacts in Mallory Vibrators are Mallory-

specified and Mallory-made to insure maximum resistance to corrosion. Therefore, Mallory Vibrators last longer on your shelf. And when you put them in use, a Mallory "self-cleaning" action prevents oxide formation—and trouble.

In addition to *dependable* starting, Mallory Vibrators give you *long life* and *high output efficiency*. For Mallory focuses on Vibrator design an unusual combination of engineering talent and resources in electronics, electrochemistry and metallurgy.

No wonder more Mallory Vibrators are used in original equipment than all other makes combined. No wonder they are best for replacements. See your Mallory Distributor.

Mallory "2448" Vibrator Deal

This deal gives you a handsome storage and display cabinet for your stock of vibrators, together with a selection of vibrators and buffer capacitors that will answer 75% of your requirements.



You pay only the service man's net price for the six vibrators and twelve buffer capacitors. There is no charge for the attractive, convenient cabinet. Your Mallory distributor has them in stock for immediate delivery.

More Mallory Vibrators are used in original equipment than all other makes combined

P. R. MALLORY & CO., Inc.
MALLORY

CAPACITORS . . . CONTROLS . . . VIBRATORS . . .
SWITCHES . . . RESISTORS . . . RECTIFIERS . . .
VIBRAPACK* POWER SUPPLIES . . . FILTERS

*Reg. U. S. Pat. Off.

APPROVED PRECISION PRODUCTS

P. R. MALLORY & CO., Inc., INDIANAPOLIS 6, INDIANA